

APPENDIX D

NHTSA Preliminary Regulatory Impact Assessment



U.S. Department
Of Transportation
National Highway
Traffic Safety Administration



Preliminary Regulatory Impact Analysis

Corporate Average Fuel Economy for MY 2012-MY 2016 Passenger Cars and Light Trucks

Office of Regulatory Analysis and Evaluation
National Center for Statistics and Analysis

August 2009

TABLE OF CONTENTS

EXECUTIVE SUMMARY	1
I. INTRODUCTION	14
II. NEED OF THE NATION TO CONSERVE ENERGY	17
III. BASELINE AND ALTERNATIVES.....	20
IV. IMPACT OF OTHER FEDERAL MOTOR VEHICLE STANDARDS ON FUEL ECONOMY	48
V. FUEL ECONOMY ENHANCING TECHNOLOGIES AND THE VOLPE MODEL.....	61
VI. MANUFACTURER CAFE CAPABILITIES.....	271
VII. COST IMPACTS.....	296
VIII. BENEFITS FROM IMPROVED FUEL ECONOMY	343
IX. IMPACT OF WEIGHT REDUCTION ON SAFETY	414
X. NET BENEFITS AND SENSITIVITY ANALYSES	441
XI. FLEXIBILITIES IN MEETING THE STANDARD.....	460
XII. PROBABILISTIC UNCERTAINTY ANALYSIS.....	463
XIII. REGULATORY FLEXIBILITY ACT AND UNFUNDED MANDATES REFORM ACT ANALYSIS.....	496

EXECUTIVE SUMMARY

This assessment examines the costs and benefits of improving the fuel economy of passenger cars and light trucks for model years (MY) 2012 through MY 2016. It includes a discussion of the technologies that can improve fuel economy, analysis of the potential impact on retail prices, safety, lifetime fuel savings and their value to consumers, and other societal benefits such as improved energy security and reduced emissions of pollutants and greenhouse gases.¹

In a previous rulemaking, the agency reformed the corporate average fuel economy (CAFE) standards with a size-based standard based on footprint.² This rulemaking continues this approach; a continuous mathematical function provides a separate fuel economy target for each footprint. Different parameters for the continuous mathematical function are derived. Individual manufacturers will be required to comply with a single fuel economy level that is based on the distribution of its production among the footprints of its vehicles. Although the same reformed CAFE scheme is required for both passenger cars and light trucks, they are established with different continuous mathematical functions specific to the vehicles' design capabilities.

The baseline assumptions for this rulemaking differ from previous analyses. In the past, the baseline was the manufacturers' confidential plans for each model year. In this analysis, the baseline is each manufacturer's MY 2008 fleet. We assume that similar vehicles will be produced through MY 2016 and technologies are added to this baseline fleet to determine what mpg levels could be achieved with technologies. This approach is more transparent than relying on manufacturers' confidential plans.

NHTSA has examined a variety of alternatives. The eight scenarios examined include five alternatives that are annual percentage improvements over the baseline. The "Preferred Alternative" would require fuel economy levels that are between the 4 and 5 percent annual increase alternatives. The "Maximum Net Benefits" alternative is based upon availability of technologies and a marginal cost/benefit analysis. In this case the model continues to include technologies until marginal cost of adding the next technology exceeds the marginal benefit. "Total Costs Equal Total Benefits": An increase in the standard to a point where essentially total costs of the technologies added together over the baseline added equals total benefits over the baseline. In this analysis, for brevity, at times it is labeled "TC = TB".

Table 1a shows the agency's projection of the actual harmonic average that would be achieved by the manufacturers, assuming those manufacturers whose plans were above the requirements would achieve those higher levels. Table 1b shows the estimated required levels. All of the tables in this analysis compare an adjusted baseline to the projected achieved harmonic average.

Costs: Costs were estimated based on the specific technologies that were applied to improve each manufacturer's fuel economy up to the level required under each alternative. Table 2 provides those cost estimates on an average per-vehicle basis, and Table 3 provides those estimates on a fleet-wide basis in millions of dollars.

¹ This analysis does not contain NHTSA's assessment of the potential environmental impacts of the final rule for purposes of the National Environmental Policy Act (NEPA), 42 U.S.C. 4321-4347.

² Vehicle Footprint is defined as the wheelbase (the distance from the center of the front axle to the center of the rear axle) times the average track width (the distance between the centerline of the tires) of the vehicle (in square feet).

Benefits: Benefits are determined mainly from fuel savings over the lifetime of the vehicle, but also include externalities such as reductions in criteria pollutants. The agency uses a 3 percent and 7 percent discount rate to value intra-generational future benefits and costs. Inter-generational³ benefits from future carbon dioxide reductions are always discounted at 3 percent, even when intra-generational benefits are discounted at 7 percent. Table 4 provides those estimates on an industry-wide basis at a 3 percent discount rate and Table 6 provides the estimates at a 7 percent discount rate.

Net Benefits: Tables 5 and 7 compares societal costs and societal benefits of each alternative at the 3 percent and 7 percent discount rates, respectively.

Fuel Savings: Table 8 shows the lifetime fuel savings in millions of gallons.

³ Inter-generational benefits, which include reductions in the expected future economic damages caused by increased global temperatures, a rise in sea levels, and other projected impacts of climate change, are anticipated to extend over a period from approximately fifty to two hundred or more years in the future, and will thus be experienced primarily by generations that are not now living.

Table 1a
Alternative CAFE Levels
Projected Achieved Harmonic Average for the Fleet, in mpg

Alternative	MY 2012	MY 2013	MY 2014	MY 2015	MY 2016
Passenger Cars					
Preferred Alternative	32.9	34.2	35.2	36.5	37.6
3% Annual Increase	32.2	33.3	34.0	34.7	35.5
4% Annual Increase	32.4	33.7	34.8	36.0	37.1
5% Annual Increase	32.6	34.4	35.9	37.2	38.7
6% Annual Increase	32.7	34.9	36.9	38.4	40.1
7% Annual Increase	32.9	35.3	37.5	39.0	41.0
Max Net Benefits	33.0	35.4	37.3	38.7	40.0
Total Cost = Total Benefit	33.2	35.6	37.8	39.2	40.9
Light Trucks					
Preferred Alternative	24.9	25.7	26.5	27.4	28.1
3% Annual Increase	24.3	24.8	25.4	26.0	26.5
4% Annual Increase	24.5	25.2	26.3	27.1	27.7
5% Annual Increase	24.6	25.7	27.0	28.2	29.0
6% Annual Increase	24.8	26.0	27.6	29.2	30.3
7% Annual Increase	25.0	26.4	28.2	29.9	31.0
Max Net Benefits	25.4	27.1	28.5	29.7	30.3
Total Cost = Total Benefit	25.5	27.2	28.8	30.1	30.8
Passenger Cars & Light Trucks					
Preferred Alternative	29.3	30.5	31.5	32.7	33.7
3% Annual Increase	28.7	29.6	30.3	31.1	31.9
4% Annual Increase	28.9	30.0	31.2	32.4	33.3
5% Annual Increase	29.1	30.6	32.1	33.5	34.8
6% Annual Increase	29.2	31.0	33.0	34.6	36.2
7% Annual Increase	29.4	31.4	33.5	35.3	37.0
Max Net Benefits	29.7	31.8	33.6	35.0	36.1
Total Cost = Total Benefit	29.8	32.0	34.0	35.5	36.9

Preferred Alternative CAFE Levels
Projected Achieved Harmonic Average for the Fleet, in gallons per 100 miles

	MY 2012	MY 2013	MY 2014	MY 2015	MY 2016
PC	3.0438	2.9267	2.8398	2.7434	2.6623
LT	4.0241	3.8952	3.7713	3.6495	3.5604

Table 1b
Alternative CAFE Levels
Estimated Required Average for the Fleet, in mpg

Alternative	MY 2012	MY 2013	MY 2014	MY 2015	MY 2016
Passenger Cars					
Preferred Alternative	33.6	34.4	35.2	36.4	38.0
3% Annual Increase	31.5	32.9	33.8	34.7	35.6
4% Annual Increase	32.1	33.6	34.8	36.1	37.4
5% Annual Increase	32.7	34.2	35.8	37.5	39.3
6% Annual Increase	33.0	34.9	36.9	38.9	41.1
7% Annual Increase	33.3	35.5	37.9	40.4	43.1
Max Net Benefits	33.4	36.0	38.1	39.5	40.9
Total Cost = Total Benefit	33.8	36.7	39.0	40.8	42.7
Light Trucks					
Preferred Alternative	25.0	25.6	26.2	27.1	28.3
3% Annual Increase	24.3	24.5	25.2	25.9	26.6
4% Annual Increase	24.3	25.0	26.0	26.9	27.9
5% Annual Increase	24.4	25.5	26.7	28.0	29.3
6% Annual Increase	24.6	26.0	27.5	29.0	30.7
7% Annual Increase	24.8	26.5	28.3	30.1	32.2
Max Net Benefits	26.4	27.7	28.8	30.1	30.6
Total Cost = Total Benefit	26.7	28.0	29.2	30.9	31.5
Passenger Cars & Light Trucks					
Preferred Alternative	29.8	30.6	31.4	32.6	34.1
3% Annual Increase	28.4	29.3	30.2	31.1	32.0
4% Annual Increase	28.7	29.9	31.0	32.3	33.6
5% Annual Increase	29.0	30.4	31.9	33.5	35.2
6% Annual Increase	29.2	31.0	32.9	34.8	36.9
7% Annual Increase	29.5	31.6	33.8	36.2	38.7
Max Net Benefits	30.4	32.5	34.2	35.6	36.8
Total Cost = Total Benefit	30.8	33.0	34.8	36.8	38.1

Estimated Required Preferred Alternative CAFE Levels
Projected Achieved Harmonic Average for the Fleet, in gallons per 100 miles

	MY 2012	MY 2013	MY 2014	MY 2015	MY 2016
PC	2.9762	2.907	2.8409	2.7473	2.6316
LT	4.0	3.9063	3.8168	3.69	3.5336

Table 2
Average Incremental Cost or Fines
Per Vehicle
(2007 Dollars)

Alternative	MY 2012	MY 2013	MY 2014	MY 2015	MY 2016
Passenger Cars					
Preferred Alternative	\$498	\$674	\$820	\$930	\$1,085
3% Annual Increase	\$139	\$298	\$398	\$483	\$580
4% Annual Increase	\$216	\$418	\$585	\$717	\$849
5% Annual Increase	\$337	\$664	\$916	\$1,079	\$1,291
6% Annual Increase	\$500	\$944	\$1,300	\$1,519	\$1,775
7% Annual Increase	\$563	\$987	\$1,406	\$1,690	\$2,046
Max Net Benefits	\$568	\$970	\$1,343	\$1,563	\$1,778
Total Cost = Total Benefit	\$633	\$1,060	\$1,478	\$1,729	\$2,028
Light Trucks					
Preferred Alternative	\$291	\$485	\$701	\$911	\$1,058
3% Annual Increase	\$114	\$203	\$329	\$483	\$575
4% Annual Increase	\$236	\$430	\$659	\$859	\$975
5% Annual Increase	\$373	\$742	\$1,179	\$1,449	\$1,641
6% Annual Increase	\$455	\$1,000	\$1,587	\$2,041	\$2,229
7% Annual Increase	\$553	\$1,240	\$1,877	\$2,374	\$2,693
Max Net Benefits	\$789	\$1,405	\$1,871	\$2,227	\$2,324
Total Cost = Total Benefit	\$815	\$1,500	\$2,074	\$2,482	\$2,633
Passenger Cars & Light Trucks					
Preferred Alternative	\$421	\$605	\$777	\$924	\$1,076
3% Annual Increase	\$130	\$263	\$373	\$483	\$578
4% Annual Increase	\$224	\$423	\$611	\$766	\$891
5% Annual Increase	\$350	\$692	\$1,010	\$1,207	\$1,409
6% Annual Increase	\$483	\$964	\$1,402	\$1,699	\$1,927
7% Annual Increase	\$559	\$1,079	\$1,574	\$1,925	\$2,263
Max Net Benefits	\$650	\$1,128	\$1,531	\$1,791	\$1,961
Total Cost = Total Benefit	\$701	\$1,220	\$1,691	\$1,988	\$2,231

Table 3
Incremental Total Costs by Societal Perspective⁴, by Alternative
(Millions of 2007 Dollars)

Alternative	MY 2012	MY 2013	MY 2014	MY 2015	MY 2016	5-Year Total
Passenger Cars						
Preferred Alternative	\$4,148	\$6,535	\$8,409	\$9,908	\$11,781	\$40,781
3% Annual Increase	\$1,179	\$2,885	\$4,076	\$5,149	\$6,332	\$19,621
4% Annual Increase	\$1,807	\$4,052	\$5,974	\$7,611	\$9,200	\$28,643
5% Annual Increase	\$2,832	\$6,453	\$9,383	\$11,470	\$13,981	\$44,118
6% Annual Increase	\$4,286	\$9,138	\$13,333	\$16,121	\$19,094	\$61,972
7% Annual Increase	\$4,820	\$9,448	\$14,195	\$17,601	\$21,451	\$67,514
Max Net Benefits	\$4,848	\$9,144	\$13,520	\$16,515	\$19,184	\$63,210
Total Cost = Total Benefit	\$5,331	\$9,864	\$14,705	\$17,919	\$21,424	\$69,243
Light Trucks						
Preferred Alternative	\$1,547	\$2,760	\$4,045	\$5,172	\$5,852	\$19,376
3% Annual Increase	\$630	\$1,158	\$1,898	\$2,743	\$3,189	\$9,617
4% Annual Increase	\$1,308	\$2,453	\$3,798	\$4,875	\$5,396	\$17,830
5% Annual Increase	\$2,063	\$4,224	\$6,783	\$8,223	\$9,081	\$30,375
6% Annual Increase	\$2,494	\$5,677	\$9,077	\$11,576	\$12,304	\$41,128
7% Annual Increase	\$3,017	\$7,034	\$10,721	\$13,382	\$14,704	\$48,856
Max Net Benefits	\$4,113	\$7,853	\$10,659	\$12,581	\$12,857	\$48,063
Total Cost = Total Benefit	\$4,177	\$8,327	\$11,790	\$13,943	\$14,515	\$52,752
Passenger Cars & Light Trucks						
Preferred Alternative	\$5,695	\$9,294	\$12,454	\$15,081	\$17,633	\$60,156
3% Annual Increase	\$1,809	\$4,043	\$5,974	\$7,892	\$9,521	\$29,238
4% Annual Increase	\$3,115	\$6,505	\$9,772	\$12,487	\$14,596	\$46,474
5% Annual Increase	\$4,895	\$10,677	\$16,165	\$19,693	\$23,062	\$74,493
6% Annual Increase	\$6,780	\$14,816	\$22,410	\$27,697	\$31,398	\$103,100
7% Annual Increase	\$7,837	\$16,482	\$24,916	\$30,982	\$36,154	\$116,371
Max Net Benefits	\$8,962	\$16,996	\$24,179	\$29,096	\$32,040	\$111,274
Total Cost = Total Benefit	\$9,507	\$18,191	\$26,495	\$31,863	\$35,939	\$121,995

⁴ Includes technology costs and societal costs, but does not include fines.

Table 4
Present Value of Lifetime Societal Benefits⁵,
by Alternative (3% Discount Rate)
(Millions of 2007 Dollars)

Alternative	MY 2012	MY 2013	MY 2014	MY 2015	MY 2016	5-Year Total
Passenger Cars						
Preferred Alternative	\$7,644	\$17,047	\$24,450	\$31,224	\$38,730	\$119,096
3% Annual Increase	\$3,367	\$10,578	\$15,652	\$20,197	\$25,962	\$75,757
4% Annual Increase	\$5,141	\$13,815	\$21,529	\$28,652	\$35,639	\$104,777
5% Annual Increase	\$6,915	\$18,010	\$27,995	\$35,592	\$45,265	\$133,777
6% Annual Increase	\$8,277	\$21,197	\$33,429	\$42,482	\$52,972	\$158,358
7% Annual Increase	\$8,916	\$22,921	\$36,032	\$46,015	\$57,389	\$171,274
Max Net Benefits	\$8,729	\$22,621	\$34,854	\$43,948	\$52,512	\$162,664
Total Cost = Total Benefit	\$9,698	\$24,214	\$37,157	\$46,624	\$57,050	\$174,744
Light Trucks						
Preferred Alternative	\$5,488	\$11,633	\$17,331	\$22,170	\$25,957	\$82,580
3% Annual Increase	\$1,969	\$5,129	\$9,274	\$13,511	\$16,418	\$46,301
4% Annual Increase	\$3,311	\$8,831	\$15,127	\$20,341	\$23,818	\$71,429
5% Annual Increase	\$4,228	\$11,526	\$20,010	\$26,902	\$31,342	\$94,009
6% Annual Increase	\$4,906	\$14,146	\$24,100	\$32,895	\$37,996	\$114,044
7% Annual Increase	\$6,129	\$16,401	\$27,520	\$36,714	\$41,708	\$128,471
Max Net Benefits	\$8,533	\$19,661	\$28,851	\$35,538	\$37,908	\$130,491
Total Cost = Total Benefit	\$8,738	\$20,213	\$30,142	\$37,736	\$40,924	\$137,752
Passenger Cars & Light Trucks						
Preferred Alternative	\$13,132	\$28,680	\$41,781	\$53,395	\$64,688	\$201,676
3% Annual Increase	\$5,336	\$15,708	\$24,925	\$33,709	\$42,380	\$122,058
4% Annual Increase	\$8,452	\$22,647	\$36,657	\$48,993	\$59,457	\$176,205
5% Annual Increase	\$11,143	\$29,536	\$48,006	\$62,494	\$76,608	\$227,786
6% Annual Increase	\$13,183	\$35,343	\$57,529	\$75,378	\$90,969	\$272,401
7% Annual Increase	\$15,045	\$39,322	\$63,552	\$82,729	\$99,097	\$299,746
Max Net Benefits	\$17,262	\$42,282	\$63,705	\$79,485	\$90,420	\$293,155
Total Cost = Total Benefit	\$18,436	\$44,426	\$67,299	\$84,360	\$97,974	\$312,496

⁵ These benefits are considered from a “societal perspective” because they include externalities. They are distinguished from a consumer perspective, because consumers generally would not think about the value of carbon dioxide, etc.

Table 5
Present Value of
Net Total Benefits⁶ by Alternative
(Millions of 2007 Dollars)
(3% Discount Rate)

Alternative	MY 2012	MY 2013	MY 2014	MY 2015	MY 2016	5-Year Total
Passenger Cars						
Preferred Alternative	\$3,496	\$10,513	\$16,041	\$21,316	\$26,949	\$78,315
3% Annual Increase	\$2,188	\$7,693	\$11,576	\$15,048	\$19,630	\$56,135
4% Annual Increase	\$3,334	\$9,763	\$15,555	\$21,041	\$26,439	\$76,133
5% Annual Increase	\$4,083	\$11,558	\$18,612	\$24,122	\$31,284	\$89,660
6% Annual Increase	\$3,991	\$12,059	\$20,096	\$26,361	\$33,878	\$96,385
7% Annual Increase	\$4,096	\$13,473	\$21,837	\$28,414	\$35,938	\$103,760
Max Net Benefits	\$3,881	\$13,478	\$21,334	\$27,433	\$33,328	\$99,453
Total Cost = Total Benefit	\$4,368	\$14,350	\$22,452	\$28,704	\$35,626	\$105,500
Light Trucks						
Preferred Alternative	\$3,941	\$8,874	\$13,286	\$16,998	\$20,106	\$63,204
3% Annual Increase	\$1,339	\$3,972	\$7,376	\$10,769	\$13,229	\$36,685
4% Annual Increase	\$2,003	\$6,378	\$11,330	\$15,465	\$18,422	\$53,598
5% Annual Increase	\$2,165	\$7,302	\$13,228	\$18,679	\$22,261	\$63,634
6% Annual Increase	\$2,412	\$8,469	\$15,023	\$21,319	\$25,693	\$72,916
7% Annual Increase	\$3,112	\$9,367	\$16,799	\$23,333	\$27,004	\$79,615
Max Net Benefits	\$4,420	\$11,808	\$18,192	\$22,957	\$25,051	\$82,428
Total Cost = Total Benefit	\$4,561	\$11,886	\$18,352	\$23,793	\$26,408	\$85,000
Passenger Cars & Light Trucks						
Preferred Alternative	\$7,438	\$19,386	\$29,327	\$38,314	\$47,055	\$141,519
3% Annual Increase	\$3,527	\$11,665	\$18,952	\$25,817	\$32,859	\$92,820
4% Annual Increase	\$5,337	\$16,142	\$26,885	\$36,507	\$44,861	\$129,731
5% Annual Increase	\$6,248	\$18,859	\$31,840	\$42,800	\$53,546	\$153,294
6% Annual Increase	\$6,403	\$20,528	\$35,119	\$47,681	\$59,571	\$169,301
7% Annual Increase	\$7,208	\$22,841	\$38,637	\$51,747	\$62,942	\$183,375
Max Net Benefits	\$8,301	\$25,286	\$39,526	\$50,389	\$58,379	\$181,881
Total Cost = Total Benefit	\$8,929	\$26,236	\$40,804	\$52,498	\$62,035	\$190,501

⁶ This table is from a societal perspective, thus, fines are deleted from the costs because they are a transfer payment.

Table 6
Present Value of Lifetime Societal Benefits⁷,
by Alternative (7% Discount Rate)
(Millions of 2007 Dollars)

Alternative	MY 2012	MY 2013	MY 2014	MY 2015	MY 2016	5-Year Total
Passenger Cars						
Preferred Alternative	\$6,037	\$13,574	\$19,533	\$25,021	\$31,107	\$95,273
3% Annual Increase	\$2,655	\$8,433	\$12,510	\$16,195	\$20,868	\$60,660
4% Annual Increase	\$4,066	\$11,021	\$17,222	\$22,985	\$28,647	\$83,941
5% Annual Increase	\$5,455	\$14,344	\$22,364	\$28,521	\$36,356	\$107,039
6% Annual Increase	\$6,541	\$16,892	\$26,708	\$34,041	\$42,544	\$126,726
7% Annual Increase	\$7,048	\$18,271	\$28,797	\$36,871	\$46,095	\$137,083
Max Net Benefits	\$6,769	\$17,911	\$27,635	\$34,638	\$41,105	\$128,058
Total Cost = Total Benefit	\$7,670	\$19,304	\$29,703	\$37,371	\$45,830	\$139,878
Light Trucks						
Preferred Alternative	\$4,255	\$9,057	\$13,533	\$17,359	\$20,361	\$64,564
3% Annual Increase	\$1,527	\$3,996	\$7,243	\$10,581	\$12,880	\$36,227
4% Annual Increase	\$2,568	\$6,879	\$11,813	\$15,926	\$18,682	\$55,868
5% Annual Increase	\$3,273	\$8,957	\$15,603	\$21,040	\$24,565	\$73,437
6% Annual Increase	\$3,798	\$10,996	\$18,784	\$25,688	\$29,737	\$89,003
7% Annual Increase	\$4,745	\$12,748	\$21,450	\$28,669	\$32,639	\$100,251
Max Net Benefits	\$6,611	\$15,227	\$22,245	\$27,534	\$29,885	\$101,501
Total Cost = Total Benefit	\$6,769	\$15,710	\$23,492	\$29,462	\$32,020	\$107,453
Passenger Cars & Light Trucks						
Preferred Alternative	\$10,293	\$22,631	\$33,066	\$42,379	\$51,468	\$159,837
3% Annual Increase	\$4,182	\$12,429	\$19,753	\$26,775	\$33,748	\$96,888
4% Annual Increase	\$6,634	\$17,899	\$29,035	\$38,911	\$47,329	\$139,809
5% Annual Increase	\$8,727	\$23,300	\$37,968	\$49,561	\$60,921	\$180,476
6% Annual Increase	\$10,338	\$27,888	\$45,493	\$59,729	\$72,281	\$215,729
7% Annual Increase	\$11,793	\$31,019	\$50,247	\$65,541	\$78,735	\$237,335
Max Net Benefits	\$13,380	\$33,138	\$49,880	\$62,172	\$70,990	\$229,560
Total Cost = Total Benefit	\$14,439	\$35,014	\$53,194	\$66,833	\$77,850	\$247,331

⁷ These benefits are considered from a “societal perspective” because they include externalities. They are distinguished from a consumer perspective, because consumers generally would not think about the value of carbon dioxide, etc.

Table 7
Present Value of
Net Total Benefits⁸ by Alternative
(Millions of 2007 Dollars)
(7% Discount Rate)

Alternative	MY 2012	MY 2013	MY 2014	MY 2015	MY 2016	5-Year Total
Passenger Cars						
Preferred Alternative	\$1,890	\$7,040	\$11,124	\$15,112	\$19,326	\$54,492
3% Annual Increase	\$1,476	\$5,548	\$8,434	\$11,046	\$14,536	\$41,039
4% Annual Increase	\$2,259	\$6,969	\$11,248	\$15,374	\$19,447	\$55,297
5% Annual Increase	\$2,623	\$7,891	\$12,982	\$17,051	\$22,375	\$62,921
6% Annual Increase	\$2,255	\$7,753	\$13,375	\$17,920	\$23,450	\$64,754
7% Annual Increase	\$2,228	\$8,823	\$14,602	\$19,271	\$24,645	\$69,569
Max Net Benefits	\$2,178	\$8,849	\$14,368	\$18,762	\$22,944	\$67,101
Total Cost = Total Benefit	\$2,340	\$9,439	\$14,998	\$19,451	\$24,406	\$70,635
Light Trucks						
Preferred Alternative	\$2,708	\$6,297	\$9,488	\$12,186	\$14,509	\$45,189
3% Annual Increase	\$898	\$2,838	\$5,345	\$7,838	\$9,692	\$26,611
4% Annual Increase	\$1,260	\$4,426	\$8,015	\$11,051	\$13,287	\$38,038
5% Annual Increase	\$1,209	\$4,732	\$8,821	\$12,817	\$15,484	\$43,062
6% Annual Increase	\$1,304	\$5,319	\$9,708	\$14,112	\$17,433	\$47,875
7% Annual Increase	\$1,728	\$5,714	\$10,729	\$15,288	\$17,936	\$51,395
Max Net Benefits	\$2,497	\$7,388	\$11,675	\$14,867	\$16,933	\$53,361
Total Cost = Total Benefit	\$2,592	\$7,383	\$11,702	\$15,519	\$17,505	\$54,701
Passenger Cars & Light Trucks						
Preferred Alternative	\$4,598	\$13,337	\$20,612	\$27,299	\$33,835	\$99,681
3% Annual Increase	\$2,373	\$8,386	\$13,780	\$18,883	\$24,227	\$67,650
4% Annual Increase	\$3,520	\$11,394	\$19,263	\$26,425	\$32,734	\$93,335
5% Annual Increase	\$3,832	\$12,623	\$21,802	\$29,867	\$37,859	\$105,983
6% Annual Increase	\$3,558	\$13,072	\$23,083	\$32,032	\$40,883	\$112,629
7% Annual Increase	\$3,956	\$14,538	\$25,331	\$34,558	\$42,581	\$120,964
Max Net Benefits	\$4,676	\$16,237	\$26,042	\$33,629	\$39,877	\$120,462
Total Cost = Total Benefit	\$4,932	\$16,823	\$26,699	\$34,971	\$41,911	\$125,336

⁸ This table is from a societal perspective, thus, fines are deleted from the costs because they are a transfer payment.

Table 8
Savings in Millions of Gallons of Fuel
Undiscounted Over the Lifetime of the Model Year

Alternative	MY 2012	MY 2013	MY 2014	MY 2015	MY 2016	5-Year Total
Passenger Cars						
Preferred Alternative	2,458	5,339	7,481	9,352	11,410	36,040
3% Annual Increase	1,093	3,315	4,792	6,047	7,640	22,886
4% Annual Increase	1,664	4,331	6,592	8,585	10,500	31,672
5% Annual Increase	2,222	5,635	8,559	10,654	13,335	40,405
6% Annual Increase	2,662	6,647	10,240	12,748	15,639	47,936
7% Annual Increase	2,869	7,187	11,037	13,806	16,944	51,844
Max Net Benefits	2,809	7,095	10,676	13,184	15,499	49,263
Total Cost = Total Benefit	3,122	7,595	11,382	13,988	16,841	52,928
Light Trucks						
Preferred Alternative	1,794	3,722	5,419	6,796	7,829	25,559
3% Annual Increase	646	1,643	2,900	4,139	4,947	14,276
4% Annual Increase	1,087	2,831	4,736	6,238	7,186	22,079
5% Annual Increase	1,358	3,657	6,230	8,213	9,424	28,882
6% Annual Increase	1,580	4,501	7,502	10,006	11,382	34,970
7% Annual Increase	1,976	5,219	8,571	11,174	12,498	39,437
Max Net Benefits	2,777	6,270	8,991	10,847	11,379	40,263
Total Cost = Total Benefit	2,844	6,446	9,396	11,486	12,256	42,428
Passenger Cars & Light Trucks						
Preferred Alternative	4,252	9,061	12,899	16,148	19,238	61,599
3% Annual Increase	1,739	4,959	7,691	10,185	12,587	37,161
4% Annual Increase	2,751	7,162	11,328	14,824	17,686	53,751
5% Annual Increase	3,580	9,292	14,789	18,868	22,758	69,287
6% Annual Increase	4,243	11,147	17,741	22,754	27,021	82,906
7% Annual Increase	4,845	12,406	19,608	24,980	29,442	91,281
Max Net Benefits	5,586	13,365	19,667	24,031	26,878	89,527
Total Cost = Total Benefit	5,966	14,041	20,778	25,474	29,097	95,357

Breakdown of costs and benefits including safety for the preferred alternative

Prior to this point, the societal costs of safety (estimated based on the impact of weight reduction on safety - see Chapter IX) have not been included in the summary tables, since they are considered a worst case estimate, and the other estimates in the analysis represent our best estimates. Tables 9 and 10 provides a breakdown of the costs and benefits for the preferred alternative using a 3 percent and 7 percent discount rate, respectively, when we include the worst case safety estimates.

Table 9
Preferred Alternative
Cost and Benefit Estimates
Passenger Cars and Light Trucks Combined
3% Discount Rate

	MY 2012	MY 2013	MY 2014	MY 2015	MY 2016	Total
Technology Costs	\$5,695	\$9,295	\$12,454	\$15,080	\$17,633	\$60,157
Benefits						
Lifetime Fuel Expenditures	\$10,197	\$22,396	\$32,715	\$41,880	\$50,823	\$158,012
Consumer Surplus from Additional Driving	\$751	\$1,643	\$2,389	\$3,029	\$3,639	\$11,451
Refueling Time Value	\$776	\$1,551	\$2,198	\$2,749	\$3,277	\$10,550
Petroleum Market Externalities	\$559	\$1,194	\$1,700	\$2,129	\$2,538	\$8,121
Congestion Costs	(\$460)	(\$934)	(\$1,332)	(\$1,657)	(\$1,991)	(\$6,376)
Noise Costs	(\$7)	(\$14)	(\$21)	(\$26)	(\$31)	(\$99)
Crash Costs	(\$217)	(\$437)	(\$625)	(\$776)	(\$930)	(\$2,985)
CO2	\$1,028	\$2,287	\$3,382	\$4,376	\$5,372	\$16,446
CO	\$0	\$0	\$0	\$0	\$0	\$0
VOC	\$41	\$80	\$108	\$131	\$156	\$518
NOX	\$82	\$132	\$155	\$174	\$200	\$744
PM	\$220	\$438	\$621	\$771	\$904	\$2,956
SOX	\$161	\$345	\$490	\$613	\$731	\$2,341
Total	\$13,132	\$28,680	\$41,781	\$53,394	\$64,687	\$201,676
Net Benefits	\$7,044	\$18,759	\$27,090	\$34,710	\$41,386	\$128,992

Table 10
Preferred
Alternative
Cost and Benefit Estimates
Passenger Cars and Light Trucks Combined
7% Discount Rate

	MY 2012	MY 2013	MY 2014	MY 2015	MY 2016	Total
Technology Costs	\$5,695	\$9,295	\$12,454	\$15,080	\$17,633	\$60,157
Benefits						
Lifetime Fuel Expenditures	\$7,991	\$17,671	\$25,900	\$33,264	\$40,478	\$125,305
Consumer Surplus from Additional Driving	\$590	\$1,301	\$1,896	\$2,412	\$2,904	\$9,102
Refueling Time Value	\$624	\$1,249	\$1,770	\$2,215	\$2,642	\$8,500
Petroleum Market Externalities	\$448	\$960	\$1,367	\$1,712	\$2,043	\$6,531
Congestion Costs	(\$371)	(\$753)	(\$1,074)	(\$1,335)	(\$1,606)	(\$5,138)
Noise Costs	(\$6)	(\$12)	(\$16)	(\$21)	(\$24)	(\$80)
Crash Costs	(\$173)	(\$352)	(\$503)	(\$626)	(\$749)	(\$2,403)
CO2	\$797	\$1,781	\$2,634	\$3,410	\$4,189	\$12,813
CO	\$0	\$0	\$0	\$0	\$0	\$0
VOC	\$33	\$65	\$87	\$106	\$125	\$416
NOX	\$60	\$99	\$120	\$135	\$156	\$570
PM	\$170	\$344	\$492	\$613	\$721	\$2,339
SOX	\$129	\$278	\$394	\$493	\$588	\$1,882
Total	\$10,292	\$22,631	\$33,066	\$42,380	\$51,468	\$159,837
Net Benefits	\$4,281	\$12,832	\$18,818	\$24,414	\$29,293	\$89,638

I. INTRODUCTION

The purpose of this study is to analyze the effects of changes in the fuel economy standards for passenger cars and for light trucks for MY 2012 - 2016. It includes a discussion of the technologies that can improve fuel economy, the potential impacts on retail prices, safety, the discounted lifetime net benefits of fuel savings, and the potential gallons of fuel saved.

The agency issued a final rule on April 7, 2003 (68 FR 16868), setting the CAFE standard applicable to light trucks for MY 2005 at 21.0 mpg, for MY 2006 at 21.6 mpg, and for MY 2007 at 22.2 mpg. On April 6, 2006 (71 FR 17566), the agency issued a final rule for light trucks for MYs 2008 to 2011 under a new “CAFE Reform” structure.

In December 2007, Congress passed the Energy Independence and Security Act (EISA). EISA mandates the setting of separate standards for passenger cars and for light trucks at levels sufficient to ensure that the average fuel economy of the combined fleet of all passenger cars and light trucks sold by all manufacturers in the U.S. in model year 2020 equals or exceeds 35 miles per gallon. EISA additionally gave NHTSA authority to reform passenger car CAFE, allowing the agency to set standards for those vehicles according to an attribute-based mathematical function.

In mid-October 2008, the agency completed and released a final environmental impact statement in anticipation of issuing standards for those years. Based on its consideration of the public comments and other available information, including information on the financial condition of the automotive industry, the agency adjusted its analysis and the standards and prepared a final rule and Final Regulatory Impact Analysis (FRIA) for MYs 2011-2015. On November 14, the Office of Information and Regulatory Affairs (OIRA) of the Office of Management and Budget concluded review of the rule and FRIA.⁹ However, issuance of the final rule was held in abeyance. On January 7, 2009, the Department of Transportation announced that the final rule would not be issued, writing:

The Bush Administration will not finalize its rulemaking on Corporate Fuel Economy Standards. The recent financial difficulties of the automobile industry will require the next administration to conduct a thorough review of matters affecting the industry, including how to effectively implement the Energy Independence and Security Act of 2007 (EISA). The National Highway Traffic Safety Administration has done significant work that will position the next Transportation Secretary to finalize a rule before the April 1, 2009 deadline.¹⁰

In light of the requirement to prescribe standards for MY 2011 by March 30, 2009 and in order to provide additional time to consider issues concerning the analysis used to determine the appropriate level of standards for MYs 2012 and beyond, the President issued a memorandum on

⁹ Record of OIRA’s action can be found at <http://www.reginfo.gov/public/do/eoHistReviewSearch> (last visited March 8, 2009). To find the report on the clearance of the draft final rule, select “Department of Transportation” under “Economically Significant Reviews Completed” and select “2008” under “Select Calendar Year.”

¹⁰ The statement can be found at <http://www.dot.gov/affairs/dot0109.htm> (last accessed February 11, 2009).

January 26, 2009, requesting the Secretary of Transportation and Administrator¹¹ of the National Highway Traffic Safety Administration NHTSA to divide the rulemaking into two parts: (1) MY 2011 standards, and (2) standards for MY 2012 and beyond.

The request that the final rule establishing CAFE standards for MY 2011 passenger cars and light trucks be prescribed by March 30, 2009 was based on several factors. One was the requirement that the final rule regarding fuel economy standards for a given model year must be adopted at least 18 months before the beginning of that model year (49 U.S.C. 32902(g)(2)). The other was that the beginning of MY 2011 is considered for the purposes of CAFE standard setting to be October 1, 2010. As part of that final rule, the President requested that NHTSA consider whether any provisions regarding preemption are consistent with the EISA, the Supreme Court's decision in *Massachusetts v. EPA* and other relevant provisions of law and the policies underlying them.

The President requested that, before promulgating a final rule concerning the model years after model year 2011, NHTSA

[C]onsider the appropriate legal factors under the EISA, the comments filed in response to the Notice of Proposed Rulemaking, the relevant technological and scientific considerations, and to the extent feasible, the forthcoming report by the National Academy of Sciences mandated under section 107 of EISA.

In addition, the President requested that NHTSA further consider whether any provisions regarding preemption are appropriate under applicable law and policy.

On March 20, 2009 (74 FR 14196) issued a final rule for MY 2011 passenger cars and light trucks, superseding the previously issued final rule for MY 2011 light trucks. Similar to this report, a Final Regulatory Impact Analysis accompanied that final rule.¹²

In keeping with the President's remarks on January 26 for new national policies to address the closely intertwined issues of energy independence, energy security and climate change, and for the initiation of serious and sustained domestic and international action to address them, NHTSA is proposing standards for MY 2012 - 2016 after collecting new information, conducting a careful review of technical and economic inputs and assumptions, and standard setting methodology, and completing new analyses.

The goal of the review and re-evaluation is to ensure that the approach used for MY 2012 and thereafter produces standards that contribute, to the maximum extent possible under EPCA/EISA, to meeting the energy and environmental challenges and goals outlined by the President. We seek to craft our program with the goal of creating the maximum incentives for innovation, providing flexibility to the regulated parties, and meeting the goal of making substantial and continuing reductions in the consumption of fuel.

¹¹ Currently, the National Highway Traffic Safety Administration does not have an Administrator. Ronald L. Medford is the Acting Deputy Administrator.

¹² "Final Regulatory Impact Analysis, Corporate Average Fuel Economy for MY 2011 Passenger Cars and Light Trucks", March 2009, Docket No. NHTSA-2009-0062-0004.1.

We will also re-examine EPCA, as amended by EISA, to consider whether additional opportunities exist for achieving the President's goals. For example, EPCA authorizes, within relatively narrow limits and subject to making specified findings, for increasing the amount of civil penalties for violating the CAFE standards.¹³ Further, while EPCA prohibits updating the test procedures used for measuring passenger car fuel economy, it places no such limitation on the test procedures for light trucks.¹⁴ If the test procedures used for light trucks were revised to provide for the operation of air conditioning during fuel economy testing, vehicle manufacturers would have a regulatory incentive to increase the efficiency and reduce the weight of air conditioning systems, thereby reducing fuel consumption and tailpipe emissions of CO₂.

The dual fuel incentive program, through which manufacturers may improve their calculated fuel economies by producing vehicles capable of operating on alternative fuels, is not considered in this analysis. By law, the agency has always analyzed fuel economy without considering the dual fuel credits.¹⁵

Throughout this analysis, unless otherwise noted, the agency has not considered the ability of manufacturers to use credits or credit trading in achieving the alternative fuel economy levels. This is also a statutory requirement.¹⁶

Throughout this document, confidential information is presented in brackets [].

¹³ Under 49 U.S.C. § 32904(c), EPA must “use the same procedures for passenger automobiles the Administrator used for model year 1975 (weighted 55 percent urban cycle and 45 percent highway cycle), or procedures that give comparable results.”

¹⁴ 49 U.S.C. § 32912(c).

¹⁵ See 49 U.S.C. § 32902(h)

¹⁶ *Id.*

II. NEED OF THE NATION TO CONSERVE ENERGY

The Energy Policy and Conservation Act (EPCA) states that:

“When deciding maximum feasible average fuel economy ... the Secretary of Transportation shall consider technological feasibility, economic practicability, the effect of other motor vehicle standards of the Government on fuel economy, and the need of the United States to conserve energy.”¹⁷

Thus, (EPCA) specifically directs the Department to balance the technological and economic challenges related to fuel economy with the nation's need to conserve energy. The concerns about energy security and the effects of energy prices and supply on national economic well-being that led to the enactment of EPCA persist today. The demand for petroleum grew in the U.S. up through the year 2005 and is now declining slowly averaging approximately 19.4 million barrels per day in 2008¹⁸. World demand, however, is expected to continue to rise until 2030¹⁹.

Since 1970, there have been a series of events that suggest that the behavior of petroleum markets is a matter for public concern.

- Average annual crude oil prices rose from \$68 per barrel in 2007 to \$95 per barrel in 2008, having peaked at \$129 per barrel in July 2008. Prices declined to \$49 per barrel in April 2009. As recently as 1998, crude prices averaged about \$13 per barrel.²⁰ Gasoline prices more than doubled during this ten-year period, from \$1.22 in 1998 to \$3.32 in 2008, declining to \$2.31 in May 2009.²¹
- U.S. domestic petroleum production stood at 10 million barrels per day in 1975, rose slightly, then declined to 6.7 million barrels per day in 2008. Between 1975 and 2008, U.S. petroleum consumption increased from 16.3 million barrels per day to 20.8 million barrels per day. In 2008, net petroleum imports accounted for 57 percent of U.S. domestic petroleum consumption²².
- Worldwide oil demand is fairly inelastic: declining prices do not induce large increases in consumption, while higher prices do not significantly restrain consumption. For example, the price of unleaded regular gasoline rose from an average of \$2.59 in 2006 to \$2.80 in 2007 (an 8.1 percent increase) and vehicle miles traveled decreased by 0.6 percent. Within the United States, demand for gasoline, diesel, and jet fuel within the transportation sector is particularly inelastic.

¹⁷ 49 U.S.C. § 32902(f)

¹⁸ U.S. Department of Energy, Energy Information Administration, *Petroleum Basic Statistics*, July 2009.

See <http://www.eia.doe.gov/emeu/international/oilconsumption.html>

¹⁹ U.S. Department of Energy, Energy Information Administration, *International Energy Outlook 2009*.

See <http://www.eia.doe.gov/emeu/international/oilconsumption.html>

²⁰ U.S. Department of Energy, Energy Information Administration, *Petroleum Marketing Monthly*, July 2009,

Table 1. See http://www.eia.doe.gov/oil_gas/petroleum/data_publications/petroleum_marketing_monthly/pmm.html

²¹ U.S. Department of Energy, Energy Information Administration, *Monthly Energy Review June 2009*, Table 9.4.

See: <http://www.eia.doe.gov/mer/pdf/mer.pdf>

²² U.S. Department of Energy, Energy Information Administration, *Monthly Energy Review, June 2009*; *Transportation Energy Data Book, Ed. 28-2009*, Table 1.12. See: <http://cta.ornl.gov/data/download28.shtml>

- Demand for oil may increase significantly in Asia and worldwide in the future resulting in upward oil cost pressure.
- Foreign oil production facilities, refineries, and supply chains have been disrupted from time to time, either by wars, political action by oil producers, civil unrest, or natural disasters.
- High oil prices, sometimes induced by disruptions in oil markets, have often coincided with rising inflation and subsequent economic recessions.
- Greenhouse gas emissions from the consumption of petroleum have become a subject of increasing public policy concern, both in the United States and internationally. Greenhouse gases in general and carbon dioxide in particular have not thus far been subject to national regulation. Studies by multiple sources suggest that rising atmospheric concentrations of greenhouse gases will damage human health and welfare.²³ There is a direct linkage between the consumption of fossil energy and emissions of the greenhouse gas carbon dioxide, as essentially all of the carbon in hydrocarbon fuels is oxidized into carbon dioxide when the fuel is combusted. Reducing U.S. fossil petroleum consumption will generally induce a proportional reduction in carbon dioxide emissions.

Energy is an essential input to the U.S. economy, and having a strong economy is essential to maintaining and strengthening our national security. Secure, reliable, and affordable energy sources are fundamental to economic stability and development. Rising energy demand poses a challenge to energy security, given increased reliance on global energy markets. As noted above, U.S. energy consumption has increasingly been outstripping U.S. energy production.

Table II-1 presents trend data on the production and consumption of petroleum for transportation. Domestic petroleum production has been decreasing over time, while imports of petroleum have been increasing to meet the rising U.S. demand for petroleum.

Conserving energy, especially reducing the nation's dependence on petroleum, benefits the U.S. in several ways. Improving energy efficiency has benefits for economic growth and the environment, as well as other benefits, such as reducing pollution and improving security of energy supply. More specifically, reducing total petroleum use decreases our economy's vulnerability to oil price shocks. Reducing dependence on oil imports from regions with uncertain conditions enhances our energy security and can reduce the flow of oil profits to certain states now hostile to the U.S.

This reformed CAFE final rule encourages conservation of petroleum for transportation by the application of broader use of fuel saving technologies, resulting in more fuel-efficient vehicles, i.e. vehicles requiring less fuel consumption per unit mile.

²³ IPCC 2007: Climate Change 2007: Synthesis Report: Contributions of Working Groups I, II, and III to the Fourth Assessment Report of the Intergovernmental Panel on Climate Change, [Core writing team, Pachauri, R.K. and Reisinger, A. 9eds.)] (Published by the Intergovernmental Panel on Climate Change, 2008). Available at <http://www.ipcc.ch/>.

Table II-1
 Petroleum Production and Supply
 (Million Barrels per Day)²⁴

	Domestic Petroleum Production	Net Petroleum Imports	U.S. Petroleum Consumption	World Petroleum Consumption	Net Imports as a Share of U.S. Consumption
1975	10.0	5.8	16.3	56.2	35.8%
1985	10.6	4.3	15.7	60.1	27.3%
1995	8.3	7.9	17.7	70.1	44.5%
2005	6.9	12.5	20.8	84.0	60.3%
2008	6.7	11.0	19.4	N/A	56.9%
<i>DOE</i>					
<i>Predictions</i>					
2015	7.6	9.7	20.2	90.6	49%
2025	9.1	8.0	20.8	101.1	40%
2030	9.3	8.4	21.7	106.6	41%

Note: DOE predictions are based on petroleum demand.

Table II-2
 Petroleum
 Transportation Consumption by Mode
 (Thousand Barrels per Day)²⁵

	Passenger Cars	Light Trucks	Total Light Vehicles	Total Transportation	Light Vehicles as % of Trans.
1975	4,836	1,245	6,081	8,474	72%
1985	4,665	1,785	6,450	9,538	68%
1995	4,440	2,975	7,415	11,347	65%
2005	5,050	3,840	8,890	13,537	66%
2007	4,850	4,032	8,883	13,710	65%

²⁴ U.S. Department of Energy, EIA, *Monthly Energy Review, June 2009*, Table 3.1. U.S. Department of Energy, EIA, *Annual Energy Outlook 2009*, Table 20.

²⁵ U.S. Department of Energy, EIA, *Transportation Energy Data Book*, Table 1.14.

III. BASELINE AND ALTERNATIVES

The baseline vehicle fleet

How did NHTSA and EPA develop the baseline market forecast?

a. Why do the agencies establish a baseline vehicle fleet?

In order to determine what levels of stringency are feasible in future model years, the agencies must project what vehicles will exist in those model years, and then evaluate what technologies can feasibly be applied to those vehicles in order to raise their fuel economy and lower their CO₂ emissions. The agencies therefore establish a baseline vehicle fleet representing those vehicles, based on the best available information. Each agency then developed a separate reference fleet, accounting (via their respective models) for the effect the MY 2011 CAFE standards have on the baseline fleet. This reference fleet is then used for comparisons of technologies' incremental cost and effectiveness, as well as the other relevant comparisons in the rule.

b. How do the agencies develop the baseline vehicle fleet?

EPA and NHTSA have based the projection of total car and total light truck sales on recent projections made by the Energy Information Administration (EIA). EIA publishes a long-term projection of national energy use annually called the Annual Energy Outlook. This projection utilizes a number of technical and econometric models which are designed to reflect both economic and regulatory conditions expected to exist in the future. In support of its projection of fuel use by light-duty vehicles, EIA projects sales of new cars and light trucks. Due to the state of flux of both energy prices and the economy, EIA published three versions of its 2009 Annual Energy Outlook. The Preliminary 2009 report was published early (in November 2008) in order to reflect the dramatic increase in fuel prices which occurred during 2008 and which occurred after the development of the 2008 Annual Energy Outlook. The official 2009 report was published in March of 2009. A third 2009 report was published a month later which reflected the economic stimulus package passed by Congress earlier this year. We use the sales projections of this latest report, referred to as the updated 2009 Annual Energy Outlook, here.

In their updated 2009 report, EIA projects that total light-duty vehicle sales gradually recover from their currently depressed levels by roughly 2013. In 2016, car and light truck sales are projected to be 9.5 and 7.1 million units, respectively. While the total level of sales of 16.6 million units is similar to pre-2008 levels, the fraction of car sales is higher than that existing in the 2000-2007 timeframe. This presumably reflects the impact of higher fuel prices and that fact that cars tend to have higher levels of fuel economy than trucks. We note that EIA's definition of cars and trucks follows that used by NHTSA prior to the 2011 CAFE final rule published earlier this year. That recent CAFE rule established the 2011 MY standards reclassified a number of 2-wheel drive sport utility vehicles from the truck fleet to the car fleet. This has the impact of shifting a considerable number of previously defined trucks into the car category. Sales projections of cars and trucks for all future model years can be found in the draft Joint TSD for this proposal.

In addition to a shift towards more car sales, sales of segments within both the car and truck markets have also been changing and are expected to continue to change in the future. Manufacturers are introducing more crossover models which offer much of the utility of SUVs but using more car-like designs. In order to reflect these changes in fleet makeup, EPA and NHTSA considered several available forecasts. After review EPA purchased and shared with NHTSA forecasts from two well-known industry analysts, CSM-Worldwide (CSM), and J.D. Powers. NHTSA and EPA decided to use the forecast from CSM, for several reasons. One, CSM agreed to allow us to publish the data, on which our forecast is based, in the public domain. Two, it covered nearly all the timeframe of greatest relevance to this proposed rule (2012-2015 model years). Three, it provided projections of vehicle sales both by manufacturer and by market segment. Four, it utilized market segments similar to those used in the EPA emission certification program and fuel economy guide. As discussed further below, this allowed the CSM forecast to be combined with other data obtained by NHTSA and EPA. We also assumed that the breakdowns of car and truck sales by manufacturer and by market segment for 2016 model year and beyond were the same as CSM's forecast for 2015 calendar year.

We then projected the CSM forecasts for relative sales of cars and trucks by manufacturer and by market segment on to the total sales estimates of the updated 2009 Annual Energy Outlook. Tables III-1 and III-2 show the resulting projections for the 2016 model year and compares these to actual sales which occurred in 2008 model year. Both tables show sales using the traditional or classic definition of cars and light trucks. Determining which classic trucks will be defined as cars using the revised definition established by NHTSA earlier this year and included in this proposed rule requires more detailed information about each vehicle model which is developed next.

	Cars		Light Trucks		Total	
	2008 MY	2016 MY	2008 MY	2016 MY	2008 MY	2016 MY
BMW	291,796	380,804	61,324	134,805	353,120	515,609
Chrysler	537,808	110,438	1,119,397	133,454	1,657,205	243,891
Daimler	208,052	235,205	79,135	109,917	287,187	345,122
Ford	641,281	990,700	1,227,107	1,713,376	1,868,388	2,704,075
General Motors	1,370,280	1,562,791	1,749,227	1,571,037	3,119,507	3,133,827
Honda	899,498	1,429,262	612,281	812,325	1,511,779	2,241,586
Hyundai	270,293	437,329	120,734	287,694	391,027	725,024
Kia	145,863	255,954	135,589	162,515	281,452	418,469
Mazda	191,326	290,010	111,220	112,837	302,546	402,847
Mitsubishi	76,701	49,697	24,028	10,872	100,729	60,569
Porsche	18,909	37,064	18,797	17,175	37,706	54,240
Nissan	653,121	985,668	370,294	571,748	1,023,415	1,557,416
Subaru	149,370	128,885	49,211	75,841	198,581	204,726
Suzuki	68,720	69,452	45,938	34,307	114,658	103,759
Tata	9,596	41,584	55,584	47,105	65,180	88,689
Toyota	1,143,696	1,986,824	1,067,804	1,218,223	2,211,500	3,205,048
Volkswagen	290,385	476,699	26,999	99,459	317,384	576,158
Total	6,966,695	9,468,365	6,874,669	7,112,689	13,841,364	16,581,055

Cars		Light Trucks			
	2008 MY	2016 MY		2008 MY	2016 MY
Full-Size Car	730,355	466,616	Full-Size Pickup	1,195,073	1,475,881
Mid-Size Car	1,970,494	2,641,739	Mid-Size Pickup	598,197	510,580
Small/Compact Car	1,850,522	2,444,479	Full-Size Van	33,384	284,110
			Mid-Size Van	719,529	615,349
Subcompact/Mini Car	599,643	1,459,138	Mid-Size MAV*	191,448	158,930
			Small MAV	235,524	289,880
Luxury Car	1,057,875	1,432,162	Full-Size SUV*	530,748	90,636
Specialty Car	754,547	1,003,078	Mid-Size SUV	347,026	110,155
Others	3,259	21,153	Small SUV	377,262	124,397
			Full-Size CUV*	406,554	319,201
			Mid-Size CUV	798,335	1,306,770
			Small CUV	1,441,589	1,866,580
Total Sales	6,966,695	9,468,365		6,874,669	7,152,470

* MAV – Multi-Activity Vehicle, SUV – Sport Utility Vehicle, CUV – Crossover Utility Vehicle

The forecasts obtained from CSM provided estimates of car and trucks sales by segment and by manufacturer, but not by manufacturer for each market segment. Therefore, we needed other information with which to base these more detailed market splits. For this task, we used as a starting point each manufacturer's sales by market segment from model year 2008. Because of the larger number of segments in the truck market, we used slightly different methodologies for cars and trucks.

The first step for both cars and trucks was to break down each manufacturer's 2008 sales according to the market segment definitions used by CSM. For example, we found that Ford's cars sales in 2008 were broken down as follows:

Full-size cars	76,762 units
Mid-size Cars	170,399 units
Small/Compact Cars	180,249 units
Subcompact/Mini Cars	none
Luxury cars	100,065 units
Specialty cars	110,805 units

We then adjusted each manufacturer's sales of each of its car segments (and truck segments, separately) so that the manufacturer's total sales of cars (and trucks) matched the total estimated for each future model year based on EIA and CSM forecasts. For example, as indicated in Table III-1, Ford's total car sales in 2008 were 641,281 units, while we project that they increase to 990,700 units by 2016. This represents an increase of 54.5 percent. Thus, we increased the 2008 sales of each Ford car segment by 54.5 percent. This produced estimates of

future sales which matched total car and truck sales per EIA and the manufacturer breakdowns per CSM (and exemplified for 2016 in Table III-1). However, the sales splits by market segment would not necessarily match those of CSM (and exemplified for 2016 in Table III.A.1-2).

In order to adjust the market segment mix for cars, we first adjusted sales of luxury, specialty and other cars. Since the total sales of cars for each manufacturer were already set, any changes in the sales of one car segment had to be compensated by the opposite change in another segment. For the luxury, specialty and other car segments, it is not clear how changes in sales would be compensated. For example, if luxury car sales decreased, would sales of full-size cars increase, mid-size cars, etc.? Thus, any changes in the sales of cars within these three segments were assumed to be compensated for by proportional changes in the sales of the other four car segments. For example, for 2016, the figures in Table III-2 indicate that luxury car sales in 2016 are 1,432,162 units. Luxury car sales are 1,057,875 units in 2008. However, after adjusting 2008 car sales by the change in total car sales for 2016 projected by EIA and a change in manufacturer market share per CSM, luxury car sales increased to 1,521,892 units. Thus, overall for 2016, luxury car sales had to decrease by 89,730 units or 6 percent. We decreased the luxury car sales by each manufacturer by this percentage. The absolute decrease in luxury car sales was spread across sales of full-size, mid-size, compact and subcompact cars in proportion to each manufacturer's sales in these segments in 2008. The same adjustment process was used for specialty cars and the "other cars" segment defined by CSM.

A slightly different approach was used to adjust for changing sales of the remaining four car segments. Starting with full-size cars, we again determined the overall percentage change that needed to occur in future year full-size cars sales after 1) adjusting for total sales per EIA, 2) manufacturer sales mix per CSM and 3) adjustments in the luxury, specialty and other car segments, in order to meet the segment sales mix per CSM. Sales of each manufacturer's large cars were adjusted by this percentage. However, instead of spreading this change over the remaining three segments, we assigned the entire change to mid-size vehicles. We did so because recent, higher fuel prices tend to cause car purchasers to purchase smaller vehicles. However, if a consumer had previously purchased a full-size car, we thought it unlikely that they would jump all the way to a subcompact. It seemed more reasonable to project that they would drop one vehicle size category smaller. Thus, the change in each manufacturer's sales of full-size cars was matched by an opposite change (in absolute units old) in mid-size cars.

The same process was then applied to mid-size cars, with the change in mid-size car sales being matched by an opposite change in compact car sales. This process was repeated one more time for compact car sales, with changes in sales in this segment being matched by the opposite change in the sales of subcompacts. The overall result was a projection of car sales for 2012-2016 which matched the total sale projections of EIA and the manufacturer and segment splits of CSM. These sales splits can be found in Chapter 1 of the draft Joint Technical Support Document for this proposal.

As mentioned above, a slightly different process was applied to truck sales. The reason for this was we could not confidently project how the change in sales from one segment preferentially went to or came from another particular segment. Some trend from larger vehicles to smaller vehicles would have been possible. However, the CSM forecasts indicated large

changes in total sport utility vehicle, multi-activity vehicle and cross-over sales which could not be connected. Thus, we applied an iterative, but straightforward process for adjusting 2008 truck sales to match the EIA and CSM forecasts.

The first three steps were exactly the same as for cars. We broke down each manufacturer's truck sales into the truck segments as defined by CSM. We then adjusted all manufacturers' truck segment sales by the same factor so that total truck sales in each model year matched EIA projections for truck sales by model year. We then adjusted each manufacturer's truck sales by segment proportionally so that each manufacturer's percentage of total truck sales matched that forecast by CSM. This again left the need to adjust truck sales by segment to match the CSM forecast for each model year.

In the fourth step, we adjusted the sales of each truck segment by a common factor so that total sales for that segment matched the combination of the EIA and CSM forecasts. For example, sales of large pickups across all manufacturer's were 1,144,166 units in 2016 after adjusting total sales to match EIA's forecast and adjusting each manufacturer's truck sales to match CSM's forecast for the breakdown of sales by manufacturer. Applying CSM's forecast of the large pickup segment of truck sales to EIA's total sales forecast indicated total large pickup sales of 1,475,881 units. Thus, we increased each manufacturer's sales of large pickups by 29 percent. The same type of adjustment was applied to all the other truck segments at the same time. The result was a set of sales projections which matched EIA's total truck sales projection and CSM's market segment forecast. However, after this step, sales by manufacturer no longer met CSM's forecast. Thus, we repeated step three and adjusted each manufacturer's truck sales so that they met CSM's forecast. The sales of each truck segment (by manufacturer) were adjusted by the same factor. The resulting sales projection matched EIA's total truck sales projection and CSM's manufacturer forecast, but sales by market segment no longer met CSM's forecast. However, the difference between the sales projections after this fifth step was closer to CSM's market segment forecast than it was after step three. In other words, the sales projection was converging. We repeated these adjustments, matching manufacturer sales mix in one step and then market segment in the next for a total of 19 times. At this point, we were able to match the market segment splits exactly and the manufacturer splits were within 0.1% of our goal, which is well within the needs of this analysis.

The next step in developing the reference fleet was to characterize the vehicles within each manufacturer-segment combination. In large part, this was based on the characterization of the specific vehicle models sold in 2008. EPA and NHTSA chose to base our estimates of detailed vehicle characteristics on 2008 sales for several reasons. One, these vehicle characteristics are not confidential and can thus be published here for careful review and comment by interested parties. Two, being actual sales data, this vehicle fleet represents the distribution of consumer demand for utility, performance, safety, etc.

We gathered most of the information about the 2008 vehicle fleet from EPA's emission certification and fuel economy database. The data obtained from this source included vehicle production volume, fuel economy, engine size, number of engine cylinders, transmission type, fuel type, etc. EPA's certification database does not include a detailed description of the types of fuel economy improving/CO₂ reducing technologies considered in this proposal. Thus, we

augmented this description with publicly available data which includes more complete technology descriptions from Wards Automotive.²⁶ In a few instances when required vehicle information was not available from these two sources (such as vehicle footprint), we obtained this information from publicly accessible internet sites such as Motortrend.com and Edmunds.com.²⁷

The projections of future car and truck sales described above apply to each manufacturer's sales by market segment. The EPA emissions certification sales data are available at a much finer level of detail, essentially vehicle configuration. As mentioned above, we placed each vehicle in the EPA certification database into one of the CSM market segments. We then totaled the sales by each manufacturer for each market segment. If the combination of EIA and CSM forecasts indicated an increase in a given manufacturer's sales of a particular market segment, then the sales of all the individual vehicle configurations were adjusted by the same factor. For example, if the Prius represented 30% of Toyota's sales of compact cars in 2008 and Toyota's sales of compact cars was projected to double by 2016, then the sales of the Prius were doubled, and the Prius sales in 2016 remained 30% of Toyota's compact car sales.

NHTSA and EPA request comment on the methodology and data sources used for developing the baseline vehicle fleet for this proposal and the reasonableness of the results.

c. How is the development of the baseline fleet for this proposal different from NHTSA's historical approach, and why is this approach preferable?

NHTSA has historically based its analysis of potential new CAFE standards on detailed product plans the agency has requested from manufacturers planning to produce light vehicles for sale in the United States. Although the agency has not attempted to compel manufacturers to submit such information, most major manufacturers and some smaller manufacturers have voluntarily provided it when requested.

As in this and other prior rulemakings, NHTSA has requested extensive and detailed information regarding the models that manufacturers plan to offer, as well as manufacturers' estimates of the volume of each model they expect to produce for sale in the U.S. NHTSA's recent requests have sought information regarding a range of engineering and planning characteristics for each vehicle model (*e.g.*, fuel economy, engine, transmission, physical dimensions, weights and capacities, redesign schedules), each engine (*e.g.*, fuel type, fuel delivery, aspiration, valvetrain configuration, valve timing, valve lift, power and torque ratings), and each transmission (*e.g.*, type, number of gears, logic).

The information manufacturers has provided in response to these requests has varied in completeness and detail. Some manufacturers have submitted nearly all of the information NHTSA has requested, have done so for most or all of the model years covered by NHTSA's requests, and have closely followed NHTSA's guidance regarding the structure of the information. Other manufacturers have submitted partial information, information for only a few

²⁶ Note that Wards Automotive is a fee-based service, but all information is public to subscribers.

²⁷ Motortrend.com and Edmunds.com are free, no-fee internet sites.

model years, and/or information in a structure less amenable to analysis. Still other manufacturers have not responded to NHTSA's requests or have responded on occasion, usually with partial information.

In recent rulemakings, NHTSA has integrated this information and estimated missing information based on a range of public and commercial sources (such as those used to develop today's market forecast). For unresponsive manufacturers, NHTSA has estimated fleet composition based on the latest-available CAFE compliance data (the same data used as part of the foundation for today's market forecast). NHTSA has then adjusted the size of the fleet based on AEO's forecast of the light vehicle market and normalized manufacturers' market shares based on the latest-available CAFE compliance data.

Compared to this approach, the market forecast the agencies have developed for this analysis has both advantages and disadvantages.

Most importantly, today's market forecast is much more transparent. The information sources used to develop today's market forecast are all either in the public domain or available commercially. Therefore, NHTSA and EPA are able to make public the market inputs actually used in the agencies' respective modeling systems, such that any reviewer may independently repeat and review the agencies' analyses. Previously, although NHTSA provided this type of information to manufacturers upon request (*e.g.*, GM requested and received outputs specific to GM), NHTSA was otherwise unable to release market inputs and the most detailed model outputs (*i.e.*, the outputs containing information regarding specific vehicle models) because doing so would violate requirements protecting manufacturers' confidential business information from disclosure.²⁸ Therefore, this approach provides much greater opportunity for informed review and comment.

Another significant advantage of today's market forecast is the agencies' ability to assess more fully the incremental costs and benefits of the proposed standards. In the past two years, NHTSA has requested and received three sets of future product plan submissions from the automotive companies, most recently this past spring. These submissions are intended to be the actual future product plans for the companies. In the most recent submission it is clear that many of the firms have been and are clearly planning for future CAFE standard increases for model years 2012 and later. This is not surprising, as much has transpired in the past two years which have provided the companies with the strong indication that there will be increases in the CAFE standards for MY2012 and later, as well as the likelihood of future GHG standards from EPA. The results for the product plans for many firms are a significant increase in their projected future application of fuel economy improvement technology. However, for the purposes of assessing the costs of the model year 2012-2016 standards the use of the product plans present a difficulty, namely, how to assess the increased costs of the proposed future standards if the companies have already anticipated the future standards and the costs are therefore now part of the agencies' baseline. This is a real concern with the most recent product plans received from the companies, and is one of the reasons the agencies have decided not to use the recent product plans to define the baseline market data for assessing our proposed standards. The approach

²⁸ See 49 CFR Part 512.

used for this proposal does not raise this concern, as the underlying data comes from model year 2008 production.²⁹

In addition, by developing a baseline fleet from common sources, the agencies have been able to avoid some errors—perhaps related to interpretation of requests—that have been observed in past responses to NHTSA’s requests. For example, while reviewing information submitted to support the most recent CAFE rulemaking, NHTSA staff discovered that one manufacturer had misinterpreted instructions regarding the specification of vehicle track width, leading to important errors in estimates of vehicle footprints. Although the manufacturer resubmitted the information with corrections, with this approach, the agencies are able to reduce the potential for such errors and inconsistencies by utilizing common data sources and procedures.

An additional advantage of the approach used for this proposal is a consistent projection of the change in fuel economy and CO₂ emissions across the various vehicles from the application of new technology. In the past, company product plans would include the application of new fuel economy improvement technology for a new or improved vehicle model with the resultant estimate from the company of the fuel economy levels for the vehicle. However, companies did not always provide to NHTSA the detailed analysis which showed how they forecasted what the fuel economy performance of the new vehicle was – that is, did it come from actual test data, from vehicle simulation modeling, from best engineering judgment or some other methodology. Thus, it was not possible either for the Agency to review the methodology used by the manufacturer, nor was it possible to review what approach the different manufacturers utilized from a consistency perspective. With the approach used for this proposal, the baseline market data comes from actual vehicles which have actual fuel economy test data – so there is no question what is the basis for the fuel economy or CO₂ performance of the baseline market data as it is actual measured data.

Another advantage of today’s approach is that future market shares are based on a forecast of what will occur in the future, rather than a static value. In the past, NHTSA has utilized a constant market share for each model year, based on the most recent year available for example from the CAFE compliance data, that is, a forecast of the 2011-2015 time frame where company market shares do not change. In the approach used today, we have utilized the forecasts from CSM of how future market shares among the companies may change over time.³⁰

The approach the agencies have taken in developing today’s market forecast does, however, have some disadvantages. Most importantly, it produces a market forecast that does not represent some important changes likely to occur in the future.

²⁹ However, as discussed below, an alternative approach that NHTSA is exploring would be to use only manufacturers’ near-term product plans, *e.g.*, from MY 2010 or MY 2011. NHTSA believes manufacturers’ near-term plans should be less subject to this concern about missing costs and benefits already included in the baseline. NHTSA is also hopeful that in connection with the agencies’ rulemaking efforts, manufacturers will be willing to make their near-term plans available to the public.

³⁰ We note that market share forecasts like CSM’s could, of course, be applied to any data used to create the baseline market forecast. If, as mentioned above, manufacturers do consent to make public MY 2010 or 2011 product plan data for the final rule, the agencies could consider applying market share forecast to that data as well.

Some of the changes not captured by today's approach are specific. For example, the agencies' current market forecast includes some vehicles for which manufacturers have announced plans for elimination or drastic production cuts such as the Chevrolet Trailblazer, the Chrysler PT Cruiser, the Chrysler Pacifica, the Dodge Magnum, the Ford Crown Victoria, the Hummer H2, the Mercury Sable, the Pontiac Grand Prix, and the Pontiac G5. These vehicle models appear explicitly in market inputs to NHTSA's analysis, and are among those vehicle models included in the aggregated vehicle types appearing in market inputs to EPA's analysis.

Conversely, the agencies' market forecast does not include some forthcoming vehicle models, such as the Chevrolet Volt, the Chevrolet Camaro, the Ford Fiesta and several publicly announced electric vehicles, including the announcements from Nissan. Nor does it include several MY 2009 vehicles, such as the Honda Insight, the Hyundai Genesis and the Toyota Venza, as our starting point for vehicle definitions was Model Year 2008. Additionally, the market forecast does not account for publicly announced technology introductions, such as Ford's EcoBoost system, whose product plans specify which vehicles and how many are planned to have this technology. Were the agencies to rely on manufacturers' product plans, today's market forecast would account for not only these specific examples, but also for similar examples that have not yet been announced publicly.

We note that, as a result of these issues, the market file may show sales volumes for certain vehicles during MYs 2012-2016 even though they will be discontinued before that time frame. Although the agencies recognize that these specific vehicles will be discontinued, we continue to include them in the market forecast because they are useful for representing successor vehicles that may appear in the rulemaking time frame to replace the discontinued vehicles in that market segment.

Other market changes not captured by today's approach are broader. For example, Chrysler Group LLC has announced plans to offer small- and medium-sized cars using Fiat powertrains. The product plan submitted by Chrysler includes vehicles that appear to reflect these plans. However, none of these specific vehicle models are included in the market forecast the agencies have developed starting with MY 2008 CAFE compliance data. The product plan submitted by Chrysler is also more optimistic with regard to Chrysler's market share during MYs 2012-2016 than the market forecast projected by CSM and used by the agencies today. Similarly, the agencies' market forecast does not reflect Nissan's plans regarding electric vehicles.

Additionally, some technical information manufacturers have provided in product plans regarding specific vehicle models is, at least insofar as NHTSA and EPA have been able to determine, not available from public or commercial sources. While such gaps do not bear significantly on the agencies' analysis, the diversity of pickup configurations necessitated utilizing a sales-weighted average footprint value³¹ for many manufacturers' pickups. Since our

³¹ A full-size pickup might be offered with various combinations of cab style (*e.g.*, regular, extended, crew) and box length (*e.g.*, 5½', 6½', 8') and, therefore, multiple footprint sizes. CAFE compliance data for MY2008 data does not contain footprint information, and does not contain information that can be used to reliably identify which pickup entries correspond to footprint values estimable from public or commercial sources. Therefore, the agencies have used the known production levels of average values to represent all variants of a given pickup line (*e.g.*, all

modeling only utilizes footprint in order to estimate each manufacturer's CO₂ or fuel economy standard and all the other vehicle characteristics are available for each pickup configuration, this approximation has no practical impact on the projected technology or cost associated with compliance with the various standards evaluated. The only impact which could arise would be if the relative sales of the various pickup configurations changed, or if we were to examine light truck standards with a different shape. This would necessitate recalculating the average footprint value in order to maintain accuracy.

The agencies have carefully considered these advantages and disadvantages of using a market forecast derived from public and commercial sources rather than from manufacturers' product plans, and we tentatively believe that the advantages outweigh the disadvantages for the purpose of proposing standards for model years 2012-2016. NHTSA's inability to release confidential market inputs and corresponding detailed outputs from the CAFE model has raised serious concerns among many observers regarding the transparency of NHTSA's analysis, as well as related concerns that the lack of transparency might enable manufacturers to provide unrealistic information to try to influence NHTSA's determination of the maximum feasible standards. While the agencies do not agree with some observers' assertions that some manufacturers have deliberately provided inaccurate or otherwise misleading information, today's market forecast is fully open and transparent, and is therefore not subject to such concerns.

With respect to the disadvantages, the agencies are hopeful that manufacturers will, in the future, agree to make public their plans regarding model years that are very near, such as MY 2010 or perhaps MY 2011, so that this information can be incorporated into an analysis that is available for public review and comment. In any event, because NHTSA and EPA are releasing market inputs used in the agencies' respective analyses, manufacturers, suppliers, and other automobile industry observers and participant can submit comments on how these inputs should be improved, as can all other reviewers.

d. How is this baseline different quantitatively from the baseline that NHTSA used for the MY 2011 (March 2009) final rule?

As discussed above, the current baseline was developed from adjusted MY 2008 data and covers MYs 2011-2016, while the baseline that NHTSA used for the MY 2011 CAFE rule was developed from confidential manufacturer product plans for MY 2011. This section describes, for the reader's comparison, some of the differences between the current baseline and the MY 2011 CAFE rule baseline.

Estimated vehicle sales:

variants of the F-150 and the Sierra/Silverado) in order to calculate the sales-weighted average footprint value for each pickup family. Again, this has no impact on the results of our modeling effort, although it would require re-estimation if we were to examine light truck standards of a different shape. In the extreme, one single footprint value could be used for every vehicle sold by a single manufacturer as long as the fuel economy standard associated with this footprint value represented the sales-weighted, harmonic average of the fuel economy standards associated with each vehicle's footprint values.

The sales forecasts, based on the Energy Information Administration's (EIA's) Annual Energy Outlook 2009 (AEO 2009), used in the current baseline indicate that the total number of light vehicles expected to be sold during MYs 2011-2015 is 77 million, or about 15.4 million vehicles annually. NHTSA's MY 2011 final rule forecast, based on AEO 2008, of the total number of light vehicles likely to be sold during MY 2011 through MY 2015 was 83 million, or about 16.6 million vehicles annually. Light trucks are expected to make up 40 percent of the MY 2011 baseline market forecast in the current baseline, compared to 42 percent of the baseline market forecast in the MY 2011 final rule. These changes in both the overall size of the light vehicle market and the relative market shares of passenger cars and light trucks reflect changes in the economic forecast underlying AEO, and changes in AEO's forecast of future fuel prices.

The figures below attempt to demonstrate graphically the difference between the variation of fuel economy with footprint for passenger cars under the current baseline and MY 2011 final rule, and for light trucks under the current baseline and MY 2011 final rule, respectively. Figures III-1 and III-2 show the variation of fuel economy with footprint for passenger car models in the current baseline and in the MY 2011 final rule, while Figures III-3 and III-4 show the variation of fuel economy with footprint for light truck models in the current baseline and in the MY 2011 final rule. However, it is difficult to draw meaningful conclusions by comparing figures from the current baseline with those of the MY 2011 final rule. In the current baseline the number of make/models, and their associated fuel economy and footprint, are fixed and do not vary over time—this is why the number of data points in the current baseline figures appears smaller as compared to the number of data points in the MY 2011 final rule baseline. In contrast, the baseline fleet used in the MY 2011 final rule varies over time as vehicles (with different fuel economy and footprint characteristics) are added to and dropped from the product mix.

Figure III-1 Planned Fuel Economy vs. Footprint, Passenger Cars in Current Baseline

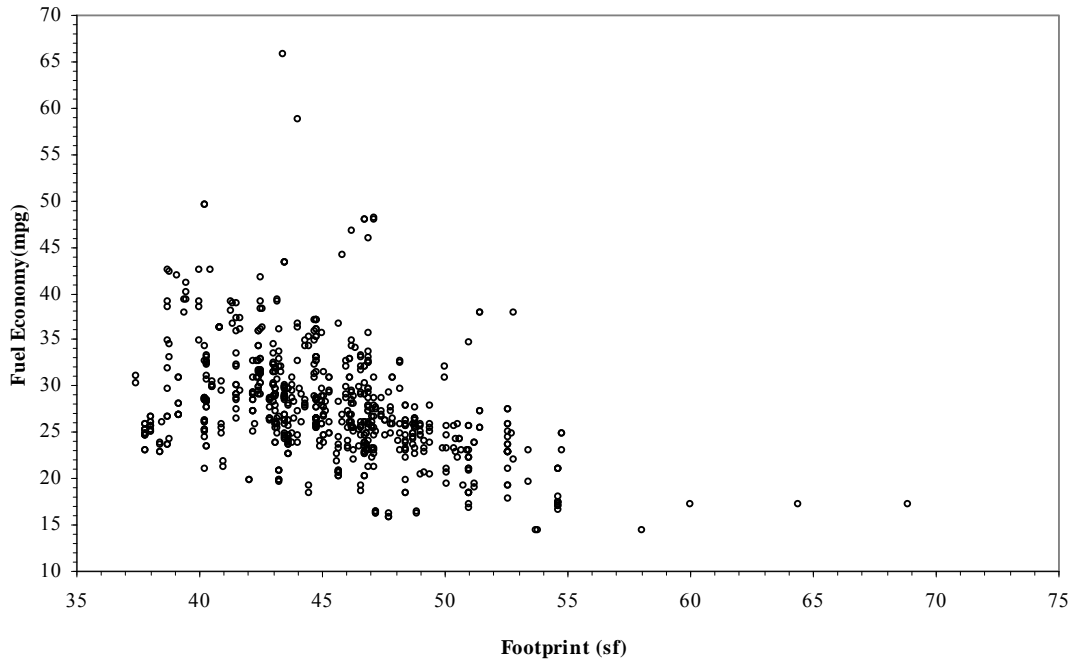

Figure III-2 Planned Fuel Economy vs. Footprint, Passenger Cars in MY 2011 Final Rule

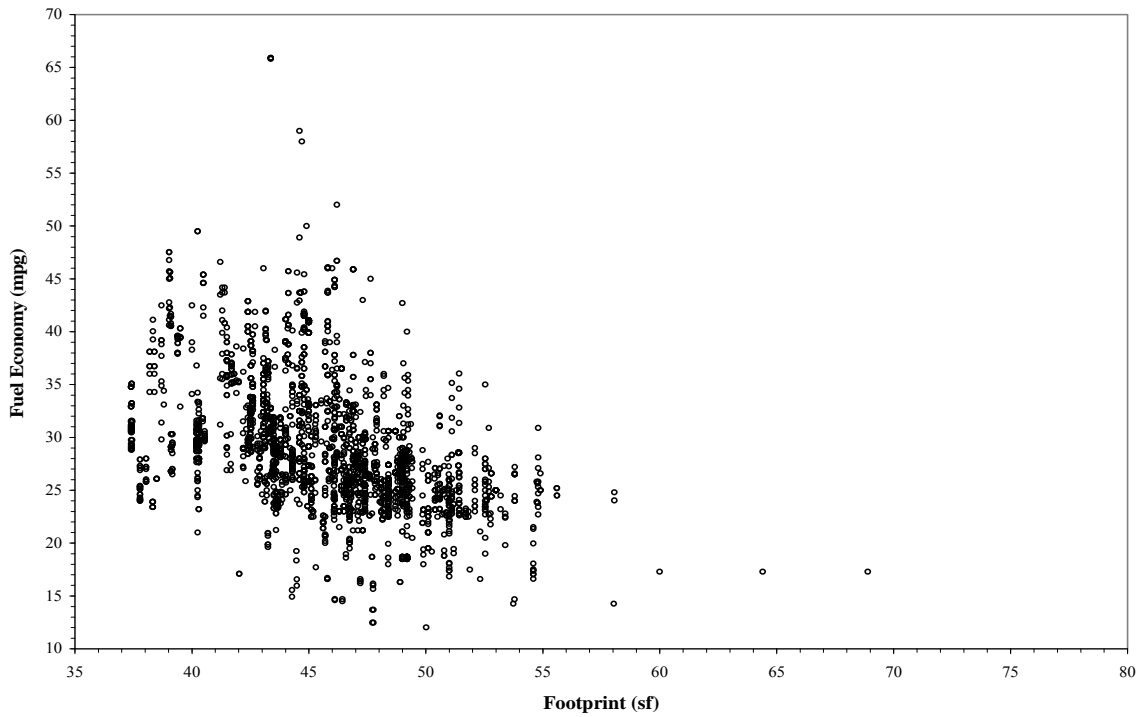

Figure III-3 Planned Fuel Economy vs. Footprint, Light Trucks in Current Baseline

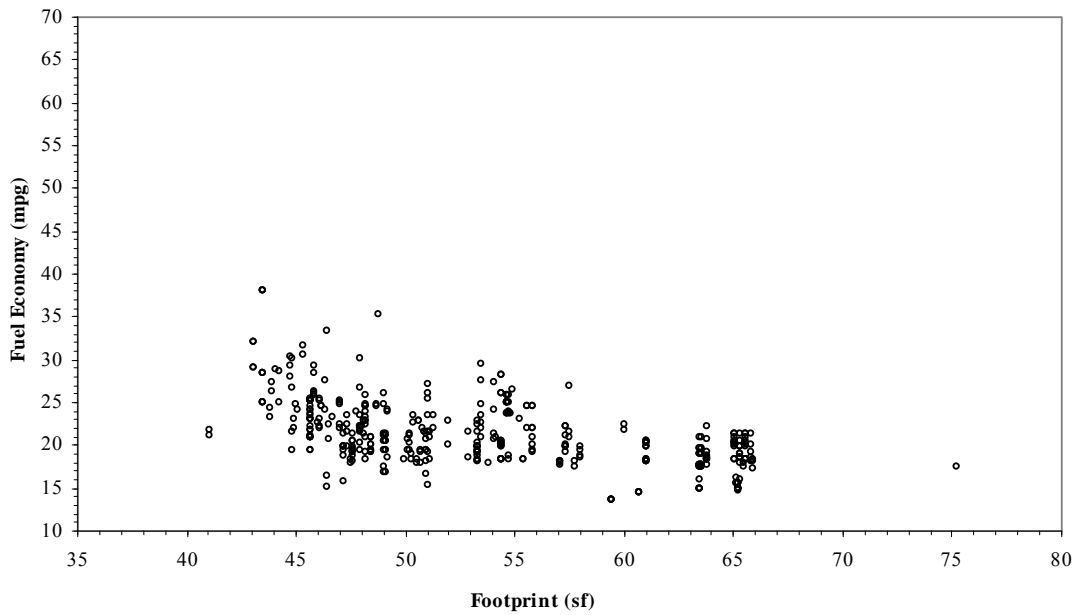
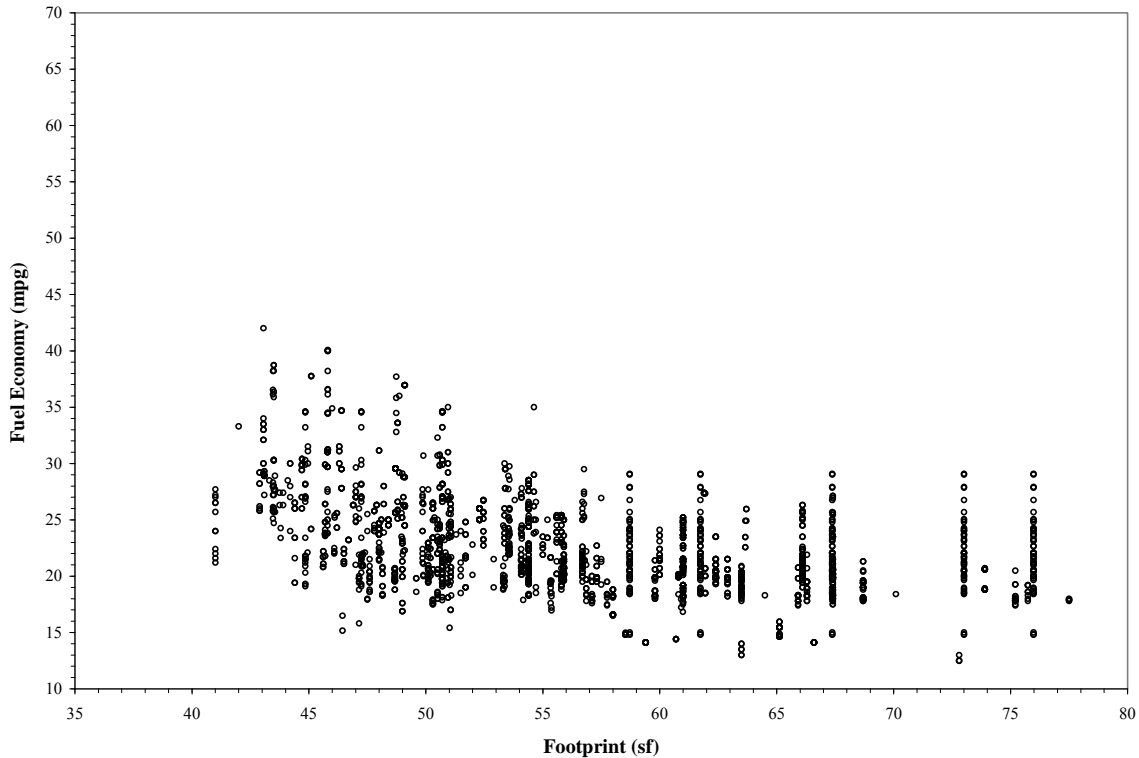

Figure III-4 Planned Fuel Economy vs. Footprint, Light Trucks in MY 2011 Final Rule

Estimated manufacturer market shares:

NHTSA's expectations regarding manufacturers' market shares (the basis for which is discussed below) have also changed since the MY 2011 final rule. These changes are reflected below in Table III-3, which shows the agency's sales forecasts for passenger cars and light trucks under the current baseline and the MY 2011 final rule.³²

³² As explained below, although NHTSA normalized each manufacturer's overall market share to produce a realistically-sized fleet, the product mix for each manufacturer that submitted product plans was preserved. The agency has reviewed manufacturers' product plans in detail, and understands that manufacturers do not sell the same mix of vehicles in every model year.

Table III-3 Sales Forecasts (Projection for U.S. Sales in MY 2011, Thousand Units)

Manufacturer	Current Baseline		MY 2011 Final Rule	
	Passenger	Nonpassenger	Passenger	Nonpassenger
Chrysler	194	403	707	1,216
Ford	1,230	944	1,615	1,144
General Motors	1,156	1,314	1,700	1,844
Honda	996	571	1,250	470
Hyundai	570	127	655	221
Kia ³³	302	98		
Nissan	794	421	789	479
Toyota	1,474	1,059	1,405	1,094
Other Asian	631	212	441	191
European	888	399	724	190
Total	8,235	5,547	9,286	6,849

Dual-fueled vehicles:

Manufacturers have also, during and since MY 2008, indicated plans to sell more dual-fueled or flexible-fuel vehicles (FFVs) in MY 2011 than indicated in the current baseline of adjusted MY 2008 compliance data. FFVs create a potential market for alternatives to petroleum-based gasoline and diesel fuel. For purposes of determining compliance with CAFE standards, the fuel economy of a FFV is, subject to limitations, adjusted upward to account for this potential.³⁴ However, NHTSA is precluded from “taking credit” for the compliance flexibility by accounting for manufacturers’ ability to earn and use credits in determining what standards would be “maximum feasible.”³⁵ Some manufacturers plan to produce a considerably greater share of FFVs than can earn full credit under EPCA. The projected average FFV share of the market in MY 2011 is 6 percent for the current baseline, versus 17 percent for the MY 2011 final rule.

Estimated achieved fuel economy levels:

Because manufacturers’ product plans also reflect simultaneous changes in fleet mix and other vehicle characteristics, the relationship between increased technology utilization and increased fuel economy cannot be isolated with any certainty. To do so would require an apples-to-apples “counterfactual” fleet of vehicles that are, except for technology and fuel economy, identical—for example, in terms of fleet mix and vehicle performance and utility. The current baseline market forecast shows industry-wide average fuel economy levels somewhat higher in MY 2011 than shown in the MY 2011 final rule. Under the current baseline, average fuel economy for MY 2011 is 26.7 mpg, versus 26.5 mpg under the baseline in the MY 2011 final rule.

³³ Kia is not listed in the table for the MY 2011 final rule because it was considered as part of Hyundai for purposes of that analysis (*i.e.*, Hyundai-Kia).

³⁴ See 49 U.S.C. §§ 32905 and 32906.

³⁵ 49 U.S.C. § 32902(h).

These differences are shown in greater detail below in Table III-4, which shows manufacturer-specific CAFE levels (not counting FFV credits that some manufacturers expect to earn) from the current baseline versus the MY 2011 final rule baseline (from manufacturers' 2008 product plans) for passenger cars and light trucks. Table III.5 shows the combined averages of these planned CAFE levels in the respective baseline fleets. These tables demonstrate that, while the difference at the industry level is not so large, there are significant differences in CAFE at the manufacturer level between the current baseline and the MY 2011 final rule baseline. For example, while Honda and Hyundai are essentially the same under both, Toyota and Nissan show increased combined CAFE levels under the current baseline (by 2.4 and 0.8 mpg respectively), while Chrysler, Ford, and GM show decreased combined CAFE levels under the current baseline (by 1.1, 1.8, and 1.0 mpg, respectively) relative to the MY 2011 final rule baseline.

Table III-4 Current Baseline Planned CAFE Levels in MY 2011 versus MY 2011 Final Rule Planned CAFE Levels (Passenger and Nonpassenger)

Manufacturer	Current baseline CAFE levels		MY 2011 planned CAFE levels	
	Passenger	Nonpassenger	Passenger	Nonpassenger
BMW	27.2	23.1	27.0	23.0
Chrysler	28.4	21.8	28.2	23.1
Ford	28.2	20.5	29.3	22.5
Subaru	29.1	25.6	28.6	28.6
General Motors	28.5	20.9	30.3	21.4
Honda	33.8	25.3	32.3	25.2
Hyundai	31.5	24.3	31.7	26.0
Tata	24.6	19.5	24.7	23.9
Kia ³⁶	31.7	23.7		
Mazda ³⁷	31.0	26.7		
Daimler	27.3	21.0	25.2	20.6
Mitsubishi	30.0	23.8	29.3	26.7
Nissan	31.9	21.5	31.3	21.4
Porsche	26.2	20.0	27.2	20.0
Ferrari ³⁸			16.2	
Maserati ³⁹			18.2	
Suzuki	30.5	23.3	28.7	24.0
Toyota	35.4	24.8	33.2	22.7
Volkswagen	28.6	20.2	28.5	20.1
Total/Average	30.8	22.3	30.4	22.6

³⁶ Again, Kia is not listed in the table for the MY 2011 final rule because it was considered as part of Hyundai for purposes of that analysis (*i.e.*, Hyundai-Kia).

³⁷ Mazda is not listed in the table for the MY 2011 final rule because it was considered as part of Ford for purposes of that analysis.

³⁸ EPA did not include Ferrari in the current baseline based on the conclusion that including them would not impact the results, and therefore Ferrari is not listed in the table for the current baseline.

³⁹ EPA did not include Maserati in the current baseline based on the conclusion that including them would not impact the results, and therefore Maserati is not listed in the table for the current baseline.

Table III-5 Current Baseline Planned CAFE Levels in MY 2011 versus MY 2011 Final Rule Planned CAFE Levels (Combined)

Manufacturer	Current baseline	MY 2011 Final Rule baseline
BMW	25.6	26.0
Chrysler	23.6	24.7
Ford	24.2	26.0
Subaru	27.5	28.6
General Motors	23.9	24.9
Honda	30.1	30.0
Hyundai	29.9	30.0
Tata	21.1	24.4
Kia	29.3	
Mazda	30.2	
Daimler	24.7	23.6
Mitsubishi	29.1	29.1
Nissan	27.3	26.6
Porsche	23.2	22.0
Ferrari		16.2
Maserati		18.2
Suzuki	28.6	27.8
Toyota	30.0	27.6
Volkswagen	26.2	27.1
Total/Average	26.7	26.5

Tables III-6 through III-8 summarize other differences between the current baseline and manufacturers' product plans submitted to NHTSA in 2008 for the MY 2011 final rule. These tables present average vehicle footprint, curb weight, and power-to-weight ratios for each manufacturer represented in the current baseline and of the seven largest manufacturers represented in the product plan data, and for the overall industry. The tables containing product plan data do not identify manufacturers by name, and do not present them in the same sequence.

Tables III-6a and 6b show that the current baseline reflects a slight decrease in overall average passenger vehicle size relative to the manufacturers' plans. This is a reflection of the market segment shifts underlying the sales forecasts of the current baseline.

Table III-6a Current Baseline Average MY 2011 Vehicle Footprint (Square Feet)

Manufacturer	PC	LT	Avg.
BMW	45.4	49.7	46.9
Chrysler	46.4	54.0	51.5
Ford	46.2	57.9	51.3
Subaru	43.1	46.3	44.4
General Motors	46.2	59.6	53.4
Honda	44.3	49.4	46.2
Hyundai	44.7	48.8	45.5
Tata	50.3	48.0	48.8
Kia	45.2	51.6	46.7
Mazda	44.3	46.9	44.7
Daimler	46.6	53.3	49.0
Mitsubishi	43.8	46.4	44.1
Nissan	45.2	55.4	48.8
Porsche	38.6	51.0	43.6
Suzuki	41.0	47.2	42.3
Toyota	44.0	51.1	47.0
Volkswagen	43.4	52.6	45.4
Industry Average	45.0	54.4	48.8

Table III-6b MY 2011 Final Rule Average Planned MY 2011 Vehicle Footprint (Square Feet)

	PC	LT	Avg.
Manufacturer 1	46.7	58.5	52.8
Manufacturer 2	46.0	5.4	47.1
Manufacturer 3	44.9	52.8	48.4
Manufacturer 4	45.4	55.8	49.3
Manufacturer 5	45.2	57.5	50.3
Manufacturer 6	48.5	54.7	52.4
Manufacturer 7	45.1	49.9	46.4
Industry Average	45.6	55.1	49.7

Tables III-7a and 7b show that the current baseline reflects a decrease in overall average vehicle weight relative to the manufacturers' plans. As above, this is most likely a reflection of the market segment shifts underlying the sales forecasts of the current baseline.

Table III-7a. Current Baseline Average MY 2011 Vehicle Curb Weight (Pounds)

Manufacturer	PC	LT	Avg.
BMW	3,535	4,612	3,900
Chrysler	3,498	4,506	4,178
Ford	3,516	4,596	3,985
Subaru	3,155	3,801	3,435
General Motors	3,495	5,030	4,311
Honda	3,021	4,064	3,401
Hyundai	3,135	4,080	3,307
Tata	3,906	5,198	4,717
Kia	3,034	4,057	3,284
Mazda	3,236	3,744	3,316
Daimler	3,450	5,123	4,045
Mitsubishi	3,238	3,851	3,312
Nissan	3,242	4,535	3,690
Porsche	3,159	4,907	3,874
Suzuki	2,870	3,843	3,080
Toyota	3,112	4,186	3,561
Volkswagen	3,479	5,673	3,959
Industry Average	3,280	4,538	3,786

Table III-7b. MY 2011 Final Rule Average Planned MY 2011 Vehicle Curb Weight (Pounds)

	PC	LT	Avg.
Manufacturer 1	3,197	4,329	3,692
Manufacturer 2	3,691	4,754	4,363
Manufacturer 3	3,293	4,038	3,481
Manufacturer 4	3,254	4,191	3,510
Manufacturer 5	3,547	5,188	4,401
Manufacturer 6	3,314	4,641	3,815
Manufacturer 7	3,345	4,599	3,865
Industry Average	3,380	4,687	3,935

Tables III-8a and 8b show that the current baseline reflects a decrease in average performance relative to that of the manufacturers' product plans. This decreased performance is most likely a reflection of the market segment shifts underlying the sales forecasts of the current baseline, that is, an assumed shift away from higher performance vehicles.

Table III-8a. Current Baseline Average MY 2011 Vehicle Power-to-Weight Ratio (hp/lb)

Manufacturer	PC	LT	Avg.
BMW	0.072	0.061	0.068
Chrysler	0.055	0.052	0.053
Ford	0.058	0.053	0.056
Subaru	0.062	0.057	0.059
General Motors	0.056	0.056	0.056
Honda	0.057	0.054	0.056
Hyundai	0.051	0.055	0.052
Tata	0.077	0.057	0.064
Kia	0.050	0.056	0.051
Mazda	0.051	0.053	0.052
Daimler	0.066	0.056	0.062
Mitsubishi	0.053	0.056	0.053
Nissan	0.058	0.057	0.058
Porsche	0.105	0.073	0.092
Suzuki	0.049	0.062	0.052
Toyota	0.052	0.062	0.056
Volkswagen	0.058	0.052	0.056
Industry Average	0.056	0.056	0.056

Table III-8b. MY 2011 Final Rule Average Planned MY 2011 Vehicle Power-to-Weight Ratio (hp/lb)

	PC	LT	Avg.
Manufacturer 1	0.065	0.058	0.060
Manufacturer 2	0.061	0.065	0.062
Manufacturer 3	0.053	0.059	0.056
Manufacturer 4	0.060	0.058	0.059
Manufacturer 5	0.060	0.057	0.059
Manufacturer 6	0.063	0.065	0.065
Manufacturer 7	0.053	0.055	0.053
Industry Average	0.060	0.059	0.060

As discussed above, the agencies' market forecast for MY 2012-2016 holds the performance and other characteristics of individual vehicle models constant, adjusting the size and composition of the fleet from one model year to the next.

Refresh and redesign schedules (for application in NHTSA's modeling):

Expected model years in which each vehicle model will be redesigned or freshened constitute another important aspect of NHTSA's market forecast. NHTSA's analysis supporting the current rulemaking times the addition of nearly all technologies to coincide with either a vehicle redesign or a vehicle freshening. Product plans submitted to NHTSA preceding the MY 2011 final rule contained manufacturers' estimates of vehicle redesign and freshening schedules and NHTSA's estimates of the timing of the five-year redesign cycle and the two- to three-year refresh cycle were made with reference to those plans. In the current baseline, in contrast, estimates of the timing of the refresh and redesign cycles were based on historical dates—*i.e.*,

counting forward from known redesigns occurring in or prior to MY 2008 for each vehicle in the fleet and assigning refresh and redesign years accordingly. After applying these estimates, the shares of manufacturers' passenger car and light truck estimated to be redesigned in MY 2011 were as summarized below for the current baseline and the MY 2011 final rule. Table III-9 below shows the percentages of each manufacturer's fleets expected to be redesigned in MY 2011 for the current baseline. Table III-10 presents corresponding estimates from the market forecast used by NHTSA in the analysis supporting the MY 2011 final rule (again, to protect confidential information, manufacturers are not identified by name).

Table III-9 Current Baseline, Share of Fleet Redesigned in MY 2011

Manufacturer	PC	LT	Avg.
BMW	32%	40%	34%
Chrysler	0%	11%	8%
Ford	12%	7%	10%
Subaru	0%	51%	22%
General Motors	20%	2%	11%
Honda	31%	33%	32%
Hyundai	20%	0%	16%
Tata	28%	100%	73%
Kia	35%	87%	48%
Mazda	0%	0%	0%
Daimler	0%	0%	0%
Mitsubishi	0%	56%	7%
Nissan	4%	18%	9%
Porsche	0%	100%	41%
Suzuki	8%	21%	11%
Toyota	4%	24%	12%
Volkswagen	23%	0%	18%
Industry Average	15%	17%	15%

Table III-10 MY 2011 Final Rule, Share of Fleet Redesigned in MY 2011

	PC	LT	Ave.
Company 1	19%	0%	11%
Company 2	34%	27%	29%
Company 3	5%	0%	3%
Company 4	7%	0%	5%
Company 5	19%	0%	11%
Company 6	34%	28%	33%
Company 7	27%	28%	28%
Overall	20%	9%	15%

We continue, therefore, to estimate that manufacturers' redesigns will not be uniformly distributed across model years. This is in keeping with standard industry practices, and reflects what manufacturers actually do—NHTSA has observed that manufacturers in fact do redesign

more vehicles in some years than in others. NHTSA staff have closely examined manufacturers' planned redesign schedules, contacting some manufacturers for clarification of some plans, and confirmed that these plans remain unevenly distributed over time. For example, although Table III-10 shows that NHTSA expects Company 2 to redesign 34 percent of its passenger car models in MY 2011, current information indicates that this company will then redesign only (a different) 10 percent of its passenger cars in MY 2012. Similarly, although Table III-10 shows that NHTSA expects four of the largest seven light truck manufacturers to redesign virtually no light truck models in MY 2011, current information also indicates that these four manufacturers will redesign 21-49 percent of their light trucks in MY 2012.

e. How does manufacturer product plan data factor into the baseline used in this proposal?

In the spring of 2009, many manufacturers submitted product plans in response to NHTSA's recent request that they do so. NHTSA and EPA both have access to these plans, and both agencies have reviewed them in detail. A small amount of product plan data was used in the development of the baseline. The specific pieces of data are:

- Wheelbase
- Track Width Front
- Track Width Rear
- EPS (Electric Power Steering)
- ROLL (Reduced Rolling Resistance)
- LUB (Advance Lubrication i.e. low weight oil)
- IACC (Improved Electrical Accessories)
- Curb Weight
- GVWR (Gross Vehicle Weight Rating)

The track widths, wheelbase, curb weight, and GVWR could have been looked up on the internet (159 were), but were taken from the product plans when available for convenience. To ensure accuracy, a sample from each product plan was used as a check against the numbers available from Motortrend.com. These numbers will be published in the baseline file since they can be easily looked up on the internet. On the other hand, EPS, ROLL, LUB, and IACC are difficult to determine without using manufacturer's product plans. These items will not be published in the baseline file, but the data has been aggregated into the EPA baseline in the technology effectiveness and cost effectiveness for each vehicle in a way that allows the baseline for the model to be published without revealing the manufacturers data.

In addition to performing analysis using the baseline common to both agencies, NHTSA has conducted a separate analysis that does make use of these product plans. However, NHTSA performed this separate analysis for purposes of comparison only. NHTSA used the publicly available baseline for all analysis related to the development and evaluation of the proposed new CAFE standards.

Considering both the publicly-available baseline used in this proposal and the product plans provided recently by manufacturers, however, it is possible that the latter could potentially be used to develop a more realistic forecast of the future light vehicle market. At the core, concerns about doing so relate to (a) uncertainty and possible inaccuracy in manufacturers'

forecasts and (b) the transparency of using product plan data. With respect to the first concern, the agencies note that manufacturers' near-term forecasts (*i.e.*, for model years two or three years into the future) should be less uncertain and more amenable to eventual retrospective analysis (*i.e.*, comparison to actual sales) than manufacturers' longer-term forecasts (*i.e.*, for model years more than five years into the future). With respect to the second concern, NHTSA has consulted with most manufacturers and believes that although few, if any, manufacturers would be willing to make public their longer-term plans, many responding manufacturers may be willing to make public their short-term plans. In a companion notice, NHTSA is seeking product plan information from manufacturers, and the agencies will also continue to consult with manufacturers regarding the possibility of releasing plans for MY 2010 and/or MY 2011 for purposes of developing and analyzing the final GHG and CAFE standards for MYs 2012-2016. The agencies are hopeful that manufacturers will agree to do so, and that NHTSA and EPA would therefore be able to use product plans in ways that might aid in increasing the accuracy of the baseline market forecast.

Alternatives

In developing the proposed alternatives for the NPRM, the agency considered the four statutory factors underlying maximum feasibility as defined in EPCA (technological feasibility, economic practicability, the effect of other standards of the Government on fuel economy, and the need of the nation to conserve energy) as well as other relevant considerations such as safety. NHTSA assessed what fuel saving technologies would be available, how effective they are, and how quickly they could be introduced. This assessment considered technological feasibility, economic practicability and associated energy conservation. We also considered other standards to the extent captured by EPCA⁴⁰ and environmental and safety concerns. This information was factored into the computer model used by NHTSA for applying technologies to particular vehicle models.

The first set of alternatives considered were 3%, 4%, 5%, 6%, and 7% annual increases over the combined (weighted passenger car and light truck) fuel economy of the MY 2011 fleet. The combined required level of fuel economy for the fleet was estimated to be 27.6 mpg for MY 2011. The agencies focused on the combined fuel economy for MY 2016 after applying the percentage improvements. In other words, the combined required fuel economy should be close to: $27.6 * 1.03^5$ for the 3 percent alternative or 32 mpg for MY 2016, $27.6 * 1.04^5$ for the 4 percent alternative or 33.6 mpg for MY 2016, $27.6 * 1.05^5$ for the 5 percent alternative or 35.2 mpg, $27.6 * 1.06^5$ for the 6 percent alternative or 36.9 mpg, $27.6 * 1.07^5$ for the 7 percent alternative or 38.7 mpg. If you take the required MY 2016 mpg for passenger cars weighted by 60 percent and the required MY 2016 mpg for light trucks weighted by 40 percent, you will get the combined average the agencies were working towards. The year by year averages were developed using technology availabilities and other factors.

In developing the mpg levels for the maximum net benefits alternative, the agency used a net benefit-maximizing analysis that used technology costs and effectiveness and placed monetary values on relevant externalities (both energy security and environmental externalities, including the benefits of reductions in CO₂ emissions). The maximum net benefits alternative reflects

⁴⁰ 71 Fed. Reg. 17566, 17669-70; April 6, 2006.

levels such marginal benefits equal marginal costs such that total benefits minus total costs are higher than at every other examined level of stringency. The maximum net benefit levels were developed using a 3 percent discount rate. When the agency ran the same analysis using a 7 percent discount rate, the mpg levels for 2016 rounded to the same numbers for both passenger cars and light trucks. So, the mpg levels were not very sensitive to the discount rate assumed. The MY 2016 levels come out between the 5% and 6% alternatives mpg levels.

The agency analyzed a “Total Cost = Total Benefit” alternative. The agency considered the “TC=TB” alternative because one or more commenters in the rulemaking on standards for MY 2011 urged NHTSA to consider setting the standards on this basis rather than on the basis of maximizing net benefits. In addition, while the Ninth Circuit Court of Appeals concluded that EPCA neither requires nor prohibits the setting of standards at the level at which net benefits are maximized, the Court raised concerns about tilting the balance more toward reducing energy consumption and CO₂. The TC = TB mpg levels are by far the highest levels examined. The TC = TB levels were developed using a 3 percent discount rate.

The Preferred Alternative would achieve a required combined average of 34.1 mpg for MY 2016, and comes out between the 4 percent and 5 percent annual increase alternative mpg levels.

Table III-11 shows the adjusted baseline for each year for passenger cars and light trucks for both the required levels and the harmonic average. The mpg levels change slightly over time due to fleet mix changes.

Table III-11
Adjusted Baseline
Required Average for the Fleet
(in mpg)

	MY 2012	MY 2013	MY 2014	MY 2015	MY 2016
Passenger Cars	30.5	30.5	30.5	30.5	30.5
Light Trucks	24.3	24.2	24.2	24.1	24.1
Combined	27.9	27.9	27.9	28.0	28.0

Adjusted Baseline
Projected Harmonic Average for the Fleet
(in mpg)

	MY 2012	MY 2013	MY 2014	MY 2015	MY 2016
Passenger Cars	31.8	31.8	31.9	31.9	32.0
Light Trucks	24.2	24.3	24.2	24.2	24.2
Combined	28.4	28.6	28.7	28.8	28.9

f. Why does NHTSA propose the preferred alternative?

The agency assessed which alternative would represent a reasonable balancing of the statutory criteria, given the difficulties confronting the industry and the economy, and the priorities and policy goals of the President. Those priorities and goals include achieving a nationally harmonized and coordinated program for regulating fuel economy and GHG emissions.

Part of that assessment entailed an evaluation of the stringencies necessary to achieve both Federal and State GHG emission reduction goals, i.e. those of California and the States that have adopted its GHG emission standard for motor vehicles. Given that EPCA requires attribute-based standards, NHTSA and EPA determined the level at which an attribute-based GHG emissions standard would need to be set to achieve the goals of California. This was done by evaluating a nationwide CAA standard for MY 2016 that would require the levels of technology upgrade, across the country, which California standards would require for the subset of vehicles sold in California under the California standards for MY 2009-2016 (known as “Pavley 1”). In essence, the stringency of the California Pavley 1 program was evaluated, but for a national standard. An assessment was developed of an equivalent national new vehicle fleet-wide CO₂ performance standard for model year 2016 which would result in the new vehicle fleet in the State of California having CO₂ performance equal to the performance from the California Pavley 1 standards. That level, 250 g/mi, is equivalent to 35.5 mpg if the GHG standard is met exclusively by fuel economy improvements.

To obtain the counterpart CAFE standard, we then adjusted that level downward to account for differences between the more prescriptive EPCA and the more flexible CAA. These differences give EPA greater ability under the CAA to provide more compliance flexibilities that would enable manufacturers to achieve compliance with a given level of requirement under the CAA at less cost than with the same level of requirement under EPCA. Principal among those greater flexibilities are the credits that EPA can provide for improving the efficiency of air conditioners and reducing the leakage of refrigerants from them. The adjustments result in a figure of 34.1 mpg as the appropriate counterpart MY 2016 CAFE standard. This differential gives manufacturers the opportunity to reach 35.5 mpg under the CAA in ways that would significantly reduce their costs. Were NHTSA instead to establish its standard at the same level, manufacturers would need to make substantially greater expenditures on fuel-saving technologies to reach 35.5 mpg under EPCA.

Based on the figure of 34.1 mpg, we created a new alternative (the Preferred alternative) whose annual percentage increases would achieve 34.1 mpg by MY 2016. That alternative is one which increases on average at 4.3% annually.

The preferred alternative involves a “faster start” toward increased stringency than do any of the alternatives that increase steadily (*i.e.*, the 3%/y, 4%/y, 5%/y, 6%/y, and 7%/y alternatives). However, by MY 2016, the stringency of the proposed standards reflects an average annual increase of 4.3%/y. The proposed standards, therefore, represent an alternative that could be referred to as “4.3% per year with a fast start” or a “front-loaded 4.3% average annual increase.”

In NHTSA’s analysis, these achieved average fuel economy levels result from the application of technology rather than changes in the mix of vehicles produced for sale in the U.S. Later in this PRIA we present detailed estimates of additional technology penetration into the

NHTSA reference fleet associated with each regulatory alternative. NHTSA has considered these results when considering the eight regulatory alternatives.

The agency began the process of winnowing the alternatives by determining whether any of the lower stringency alternatives should be eliminated from consideration. To begin with, the agency needs to ensure that its standards are high enough to enable the combined fleet of passenger cars and light trucks to achieve at least 35 mpg not later than MY 2020, as required by EISA. Achieving that level makes it necessary for the chosen alternative to increase at over 3 percent annually.

NHTSA has concluded that it must reject the 3%/y and 4%/y alternatives. Given that CO₂ and fuel savings are very closely correlated, the 3%/y and 4%/y alternatives would not produce the reductions in fuel savings and CO₂ emissions that the Nation needs at this time. Picking either of those alternatives would unnecessarily result in foregoing substantial benefits, in terms of fuel savings and reduced CO₂ emissions, which would be achievable at reasonable cost. Further, NHTSA has tentatively concluded that it must reject the 3%/y and 4%/y alternatives, as neither would lead to the regulatory harmonization that forms a vital core principle of the National Program that EPA and NHTSA are jointly striving to implement. In order to achieve a harmonized National Program, an average annual increase of 4.3% is necessary.

In contrast, at the upper end of the range of alternatives, the agency was concerned that the increased benefits offered by those alternatives were available only at excessive cost and might not be practicable in all cases within the available leadtime.

NHTSA first considered the environmentally-preferable alternative. Based on the information provided in the DEIS, the environmentally-preferable alternative would be that involving stringencies at which total costs most nearly equal total benefits. NHTSA notes that NEPA does not require that agencies choose the environmentally-preferable alternative if doing so would be contrary to the choice that the agency would otherwise make under its governing statute. Given the levels of stringency required by the environmentally-preferable alternative and the lack of lead time to achieve such levels between now and MY 2016, NHTSA tentatively concludes that the environmentally-preferable alternative would not be economically practicable or technologically feasible, and thus tentatively concludes that it would result in standards that would be beyond the level achievable for MYs 2012-2016.

NHTSA determined that it would be inappropriate to propose any of the other more stringent alternatives due to concerns over lead time and economic practicability. At a time when the entire industry remains in an economically critical state, NHTSA believes that it would be unreasonable to propose more stringent standards. Even in a case where economic factors were not a consideration, there are real-world time constraints which must be considered due to the short lead time available for the early years of this program, in particular for MYs 2012 and 2013.

As revealed by the figures shown above, the proposed standards already require aggressive application of technologies, and more stringent standards which would require more widespread use (including more substantial implementation of advanced technologies such as stoichiometric gasoline direct injection engines and strong hybrids) raise serious issues of adequacy of lead time, not only to meet the standards but to coordinate such significant changes with manufacturers' redesign cycles.

NHTSA does not believe that more stringent standards would meet EPCA's requirement that CAFE standards be economically practicable. Increasing stringency beyond the proposed standards would entail significant additional application of technology—technology that, though perhaps feasible for individual vehicle models, would not be economically practicable for the industry at the scales involved. Among the more stringent alternatives, the one closest in stringency to the standards proposed today is the alternative under which combined CAFE stringency increases at 5% annually. This alternative would yield fuel savings and CO₂ reductions about 12% and 9% higher, respectively, than the proposed standards. However, compared to the proposed standards, this alternative would increase outlays for new technologies during MY 2012-2016 by about 24%, or \$14 billion. Average MY 2016 cost increases would, in turn, rise from \$1,076 under the proposed standards to \$1,409 when stringency increases at 5% annually. This represents a 30% increase in per-vehicle cost for only a 3% increase in average performance (on a gallon-per-mile basis to which fuel savings are proportional).

NHTSA has concluded that the proposed standards are technologically feasible and economically practicable. The proposed standards will require manufacturers to apply considerable additional technology. Although NHTSA cannot predict how manufacturers *will* respond to the proposed standards, the agency's analysis indicates that the standards could lead to significantly greater use of advanced engine and transmission technologies.

In summary, NHTSA has considered eight regulatory alternatives, including the proposed standards, examining technologies that could be applied in response to each alternative, as well as corresponding costs, effects, and benefits. The agency has concluded that alternatives less stringent than the proposed standards would not produce the fuel savings and CO₂ reductions necessary at this time to achieve either the overarching purpose of EPCA, *i.e.*, energy conservation, or an important part of the regulatory harmonization underpinning the National Program. Conversely, the agency has concluded that more stringent standards would involve levels of additional technology and cost that, considering the fragile state of the automotive industry, would not be economically practicable. Therefore, having considered these eight regulatory alternatives, and the statutorily-relevant factors of technological feasibility, economic practicability, the effect of other motor vehicle standards of the Government on fuel economy, and the need of the United States to conserve energy, along with other relevant factors such as the safety impacts of the proposed standards,⁴¹ NHTSA tentatively concludes that the proposed standards represent a reasonable balancing of all of these concerns, and are the maximum feasible average fuel economy levels that the manufacturers can achieve in MYs 2012-2016.

⁴¹ See Section IV.G.6 below.

IV. IMPACT OF OTHER FEDERAL MOTOR VEHICLE STANDARDS ON FUEL ECONOMY

Introduction

The Energy Policy and Conservation Act (EPCA or the Act) requires that fuel economy standards be set at the maximum feasible level after taking into account the following criteria: (1) technological feasibility, (2) economic practicability, (3) the impact of other Government Standards on fuel economy, and (4) the need of the Nation to conserve energy. Using MY 2008 as a baseline, this section discusses the effects of other government regulations on model year (MY) 2012-2016 passenger car and light truck fuel economy. These effects have not been included in the Volpe model at this time, which is based on MY 2008 vehicles. Comments are requested on the appropriate group of weights to include in the model in the future. Should they be only those final rules that have been issued, final rules that have been issued and those rulemakings that are almost certainly to be a final rule (including some that are required by Congress), or should they also include voluntary safety countermeasures that manufacturers are planning on making.

The Impact on Weight of Safety Standards and Voluntary Safety Improvements

The fuel economy impact of safety improvements will typically take the form of increased vehicle weight, which reduces the fuel economy of the vehicle. The agency's estimates are based on cost and weight tear-down studies of a few vehicles and cannot possibly cover all the variations in the manufacturers' fleets. NHTSA requested and various manufacturers provided confidential estimates in 2009 of increases in weight resulting from safety improvements. Those increases are shown in subsequent tables.

We have broken down our analysis of the impact of safety standards that might affect the MY 2012-16 fleets into three parts: 1) those NHTSA final rules with known effective dates, 2) proposed rules or soon to be proposed rules by NHTSA, without final effective dates, and 3) currently voluntary safety improvements planned by the manufacturers.

Weight Impacts of Required Safety Standards (Final Rules)

The National Highway Traffic Safety Administration (NHTSA) has issued several safety standards that become effective for passenger cars and light trucks between MY 2009 and MY 2016. We will examine the potential impact on passenger car and light truck weights for MY 2012-2016, using MY 2008 as a baseline.

1. FMVSS 126, Electronic Stability Control
2. FMVSS 206, Door Latches for Sliding Doors
3. FMVSS 208, 35 mph Belted Testing of 5th Female
4. FMVSS 214, Side Impact Oblique Pole Test
5. FMVSS 216, Roof Crush

FMVSS 126, Electronic Stability Control

The phase-in schedule for vehicle manufacturers is:

Table IV-1
Electronic Stability Control Effective Dates Phase-in Schedule

Model Year	Production Beginning Date	Requirement
2009	September 1, 2008	55% with carryover credit
2010	September 1, 2009	75% with carryover credit
2011	September 1, 2010	95% with carryover credit
2012	September 1, 2011	All light vehicles

The final rule requires all light vehicles to meet the ESC requirements by MY 2012. In comparison, the MY 2008 voluntary compliance was estimated as shown in Table IV-1. All light vehicles must meet the requirements by MY 2012.

Table IV-2
MY 2008 Voluntary Compliance

	Passenger Cars	Light Trucks
ABS and ESC	36%	64%
ABS alone	46%	35%
No systems	18%	1%

The agency's analysis⁴² of weight impacts found that ABS adds 10.7 lbs. and ESC adds 1.8 lbs. per vehicle for a total of 12.5 lbs. Based on manufacturers' plans for voluntary installation of ESC in MY 2008, 82 percent of passenger cars would have ABS and 36 percent would have ESC. Thus, the MY 2008 weight added by the manufacturers' plans for passenger cars would be 9.42 lbs. ($0.82 \times 10.7 + 0.36 \times 1.8$).

The incremental weight for each year of MY 2012-2016 compared to the MY 2008 baseline is 3.08 lbs. for passenger cars (12.5 – 9.42 lbs) and 0.75 lbs. for light trucks (12.5 – 11.75 lbs.) for the ESC requirements.

FMVSS 206, Door locks

A new door lock test for sliding doors took effect in MY 2009. This test was expected to force those sliding doors that used a latch/pin mechanism to change to two latches to help keep sliding doors closed during crashes. The increase in weight is estimated to be 1.0 lbs. Several van models had two sliding doors. Out of 1.4 million MY 2003 vans an estimated 1.2 million doors needed to be changed to the two latch system. Given that vans were 13.2 percent of light truck sales in MY 2007, it is estimated that in MY 2009, average light truck weight would be increased by 0.11 lbs. for sliding door latches ($1.2/1.4 \text{ million} \times 0.132 \times 1 \text{ lb.}$). The incremental weight for

⁴² "Final Regulatory Impact Analysis, FMVSS 126, Electronic Stability Control Systems", March 2007, NHTSA, Docket No. 2007-27662-2.

each year of MY 2012-2016 compared to the MY 2008 baseline is 0 lbs. for passenger cars and 0.11 lbs. for light trucks for the sliding door latch requirements.

FMVSS 208, Occupant Crash Protection – 35 mph belted 50th percentile male and 5th percentile female testing

The agency phased-in requirements for 35 mph belted testing with the 50th percentile male were 35 percent for MY 2008, 65 percent for MY 2009, and 100 percent for MY 2010. The agency phased-in requirements for 35 mph belted testing with the 5th percentile female were 35 percent for MY 2010, 65 percent for MY 2011, and 100 percent for MY 2012. Several different technologies could be used to pass this test, but the agency’s analysis of these countermeasures showed no increase in weight was needed. Some of the manufacturers’ confidential submissions show weight increases for FMVSS 208.

FMVSS 214, Oblique Pole Side Impact Test

The phase-in requirements for the side impact test are as shown below in Table IV-3:

Table IV-3
FMVSS 214 Final Rule Phase-In Schedule

Phase-in Date	Percent of each manufacturer’s light vehicles that must comply during the production period
September 1, 2010 to August 31, 2011	20 percent (excluding vehicles GVWR > 8,500 lbs.)
September 1, 2011 to August 31, 2012	40 percent vehicles (excluding vehicles GVWR > 8,500 lbs.)
September 1, 2012 to August 31, 2013	60 percent vehicles (excluding vehicles GVWR > 8,500 lbs.)
September 1, 2013 to August 31, 2014	80 percent vehicles (excluding vehicles GVWR > 8,500 lbs.)
On or after September 1, 2014	All vehicles including limited line vehicles, except vehicles with GVWR > 8,500 lbs., alterers, and multi-stage manufacturers
On or after September 1, 2015	All vehicles, including vehicles with GVWR > 8,500 lbs., excluding alterers and multi-stage manufacturers
On or after September 1, 2016	All vehicles, including vehicles with GVWR > 8,500 lbs., alterers and multi-stage manufacturers

A teardown study of five thorax air bags resulted in an average weight increase per vehicle of 4.77 pounds (2.17 kg).⁴³ A second study⁴⁴ performed teardowns of 5 window curtain systems. One of the window curtain systems was very heavy (23.45 pounds). The other four window curtain systems had an average weight increase per vehicle of 6.78 pounds (3.08 kg), a figure which is assumed to be average for all vehicles in the future.

⁴³ Khadilkar, et al. “Teardown Cost Estimates of Automotive Equipment Manufactured to Comply with Motor Vehicle Standard – FMVSS 214(D) – Side Impact Protection, Side Air Bag Features”, April 2003, DOT HS 809 809.

⁴⁴ Ludtke & Associates, “Perform Cost and Weight Analysis, Head Protection Air Bag Systems, FMVSS 201”, page 4-3 to 4-5, DOT HS 809 842.

Based on MY 2008 Buying a Safer Car data supplied by the manufacturers, the projected number of side air bags with head protection was 98.5 percent of passenger cars and 85.4 percent of light trucks and torso protection was projected at 92.1 percent of passenger cars and 50.1 percent of light trucks. Combined this information indicates that on average the MY 2012 phase-in requirement would be already be met voluntarily in MY 2008 and that the weight increases for MY 2013 would be 0 for passenger cars and 0.47 lbs. for light trucks, MY 2014 would be 0 for passenger cars and 1.43 lbs. for light trucks, MY 2015 would be 0.06 lbs. for passenger cars and 2.08 lbs. for light trucks, and MY 2016 would be 0.64 lbs. for passenger cars and 2.45 lbs. for light trucks.

FMVSS 216, Roof Crush

On May 12, 2009, NHTSA issued a final rule amending the roof crush standard from 1.5 times the vehicle weight to 3.0 times the vehicle weight for passenger cars and light trucks of 6,000 lbs. GVWR or less.⁴⁵ Vehicles over 6,000 lbs. and less than 10,000 lbs. GVWR will be required to meet the same test but at 1.5 times the vehicle weight. In the FRIA, the average passenger car and light truck weight was estimated to increase weight by 7.9 to 15.4 lbs. The average weight of 11.65 lbs. will be used in later tables and will be multiplied by the percentages in Table IV-4 to get incremental weights by model year (2.91 lbs. in MY 2013, 5.83 lbs. in MY 2014, 8.74 lbs. in MY 2015, and 11.65 lbs. in MY 2016). The final rule effective dates are shown in Table IV-4.

Table IV-4
FMVSS 216 Final Rule Phase-In Schedule

Phase-in Date	Percent of each manufacturer's light vehicles that must comply during the production period
September 1, 2012 to August 31, 2013	25 percent
September 1, 2013 to August 31, 2014	50 percent
September 1, 2014 to August 31, 2015	75 percent
On or after September 1, 2015	All vehicles

FMVSS 301 Fuel System Integrity

NHTSA issued a final rule changing the rear impact test procedure to a 50 mph offset test. The phase-in effective dates are 40 percent for MY 2007, 70 percent for MY 2008, and 100 percent for MY 2009. Thus, an incremental 30 percent of the fleet needs to meet the standard in comparison to the MY 2008 baseline. Several different countermeasures could be used to meet the standard. Averaging the most likely two resulted in an estimated 3.7 lbs. to passenger cars and light trucks. Assuming an incremental 30 percent of the fleet for MY 2009 at 3.7 lbs., results in an increase of 1.11 lbs. for the average vehicle.

⁴⁵ Final Regulatory Impact Analysis, FMVSS 216 Upgrade Roof Crush Resistance, (Docket No. 2009-0093-4) (May 12, 2009) (74 FR 22347)

Planned NHTSA initiative on Ejection Mitigation

The agency is planning on issuing a proposal on ejection mitigation. The likely result of the planned proposal is for window curtain side air bags (likely to be used to meet the FMVSS 214 oblique pole test in all vehicles) to be larger and for a rollover sensor to be installed. Preliminary agency estimates are that there will be a weight increase of about 2 lbs. Since the proposal has not been issued, effective dates and the phase-in schedule are highly speculative at this time. For this analysis, we'll assume a schedule of 25% in MY 2014, 50% in MY 2015, and 75% in MY 2016, resulting in weight increases of 0.5 lbs. in MY 2014, 1 lb. in MY 2015, and 1.5 lbs. in MY 2016 for both passenger cars and light trucks.

In addition, advanced glazing is one alternative that manufacturers might pursue for specific window applications for ejection mitigation (possibly for fixed windows for third row applications) or more broadly. Advanced glazing is likely to have weight implications. The agency has not made an estimate of the likelihood that advanced glazing might be used or its weight implications.

NHTSA initiative on Pedestrian Protection

The agency has started to analyze the costs and benefits of a Global Technical Regulation on pedestrian protection. The effective dates have not been decided, however, it is possible that a rule on pedestrian protection could start to be phased in by the end of the period of this proposed rulemaking. Potential weight increases for pedestrian head and leg protection have not yet been identified.

Summary – Overview of Anticipated Weight Increases

Table IV-5 summarizes estimates made by NHTSA regarding the weight added by the above discussed standards or likely rulemakings. NHTSA estimates that weight additions required by final rules and likely NHTSA regulations effective by MY 2016, compared to the MY 2008 fleet, will increase passenger car weight by at least 17.98 lbs. and light truck weight by at least 17.57 lbs.

Table IV-6 shows the distribution by model year.

Table IV-5

Weight Additions Due to Final Rules or Likely NHTSA Regulations
Comparing MY 2016 to the MY 2008 Baseline fleet

Standard No.	Added Weight in pounds Passenger Car	Added Weight in kilograms Passenger Car	Added Weight in pounds Light Trucks	Added Weight in kilograms Light trucks
126	3.08	1.40	0.75	0.34
206	0	0	0.11	0.05
214	0.64	0.29	2.45	1.11
216	11.65	5.28	11.65	5.28
301	1.11	0.50	1.11	0.50
Ejection Mitigation	1.5	0.68	1.5	0.68
Pedestrian Protection	?	?	?	?
Total	17.98	8.16	17.57	7.97

Table IV-6

**Weight Additions by Model Year
Due to Final Rules or Likely NHTSA Regulations
Compared to a MY 2008 Baseline**

	Added Weight in pounds Passenger Car	Added Weight in kilograms Passenger Car	Added Weight in pounds Light Trucks	Added Weight in kilograms Light trucks
MY 2012	4.19	1.90	1.97	0.89
MY 2013	7.10	3.22	5.35	2.43
MY 2014	10.52	4.77	9.73	4.41
MY 2015	13.99	6.35	13.79	6.26
MY 2016	17.98	8.16	17.57	7.97

Based on NHTSA's weight-versus-fuel-economy algorithms, a 3-4 pound increase in weight equates to a loss of 0.01 mpg in fuel economy. Assuming an average of 3.5 pounds increase in weight equates to a loss of 0.01 mpg in fuel economy, Table IV-7 shows the results for final rules or likely future safety standards.

Table IV-7

**Estimated mpg Impact of Weight Additions by Model Year
Due to Final Rules or Likely NHTSA Regulations
Compared to a MY 2008 Baseline**

	MPG Impact of Added Weight Passenger Car	MPG Impact of Added Weight Light Trucks
MY 2012	0.012	0.006
MY 2013	0.020	0.015
MY 2014	0.030	0.028
MY 2015	0.040	0.039
MY 2016	0.051	0.050

CONFIDENTIAL SUBMISSIONS

Weight Impacts of Potential Future Voluntary Safety Improvements

At the time the agency requested information about fuel economy plans and capabilities for the future, the agency also requested information on weight increases that could occur due to safety improvements. Several manufacturers provided confidential information in 2009 about plans they had to meet final rules, proposed safety standards, or to voluntarily increase safety for the years 2012-2016. The plans are compared to a MY 2008 baseline fleet. The areas covered above and the regulatory areas described as final and proposed, and voluntary safety initiatives from manufacturers that have confidential increases for the period after MY 2008 are shown in the following tables. [

Table IV-8

GM Estimates of Impact on mpg

	MY 2012	MY 2013	MY 2014	MY 2015	MY 2016
Domestic PC					
Import PC					
Trucks					

[Table IV-9a
Confidential Submissions of Weight Impacts compared to a
Baseline of MY 2008

		Ford											
		Car MY					Light Truck MY						
		2012	2013	2014	2015	2016	2012	2013	2014	2015	2016		
<i>Final and Proposed</i>													
126	ESC												
208	5 th Female Belted												
214	Side Impact												
216	Roof Crush												
226	Ejection Mitigation												
301	Fuel System												
Total Final and Proposed Rule Increments													
<i>Voluntary and Other Rules</i>													
202a	Head Restraints												
TBD	Ped. Protection												
TBD	Compatibility												
N/A	EDR part 563												
	Other Voluntary												
Total Voluntary and Other Rule Increments													
Total by Year													

[Table IV-9b
Confidential Submissions of Weight Impacts compared to a
Baseline of MY 2008

<i>Final and Proposed</i>		General Motors										
		Car MY					Light Truck MY					
		2012	2013	2014	2015	2016	2012	2013	2014	2015	2016	
126	ESC											
208	5th Female Belted											
214	Side Impact											
216	Roof Crush											
226	Ejection Mitigation											
301	Fuel System											
Total Final and Proposed Rule Increments												
<i>Voluntary and Other Rules</i>												
202a	Head Restraints											
TBD	Ped. Protection											
TBD	Compatibility											
N/A	EDR part 563											
	Other Voluntary											
Total Voluntary and Other Rule Increments												
Total by Year												

[Table IV-9c
Confidential Submissions of Weight Impacts compared to a
Baseline of MY 2008

<i>Final and Proposed</i>		Chrysler										
		Car MY					Light Truck MY					
		2012	2013	2014	2015	2016		2012	2013	2014	2015	2016
126	ESC											
208	5th Female Belted											
214	Side Impact											
216	Roof Crush Ejection											
226	Mitigation											
301	Fuel System											
Total Final and Proposed Rule Increments												
<i>Voluntary and Other Rules</i>												
202a	Head Restraints											
TBD	Ped. Protection											
TBD	Compatibility											
	EDR part 563											
	Other											
N/A	Voluntary											
Total Voluntary and Other Rule Increments												
Total by Year												

Fuel Economy Impacts of Government Emission Standards

The only program EPA has that has been finalized but is not yet in-force for light-duty vehicles and MDPVs is the new cold hydrocarbon standard finalized under the Mobile Source Air Toxics (MSAT) rule. For <6,000 lb. vehicles the standard begins in MY 2010. But for 6,000-8,500 lb. GVWR vehicles and for MDPVs, the standard has a phase-in that starts with MY 2012 and ends in MY 2015. EPA estimated the new standard could have a small, but unquantified, impact on improving fuel consumption during cold start conditions. However, in the temperature range during which the CAFE test procedures are performed (68 - 86 deg. F), EPA does not believe the new cold hydrocarbon standard will have any impact on fuel economy. Therefore, the impact on fuel economy is expected to be zero for both passenger cars for light trucks.

V. FUEL ECONOMY ENHANCING TECHNOLOGIES AND THE VOLPE MODEL

A. The Volpe Model

In developing the alternative CAFE standards, NHTSA has made significant use of results produced by the CAFE Compliance and Effects Model (commonly referred to as the Volpe model), which DOT's Volpe National Transportation Systems Center developed specifically to support NHTSA's CAFE rulemakings.

The agency uses the Volpe model to estimate the extent to which manufacturers could attempt to comply with a given CAFE alternative by adding technology. This exercise constitutes a simulation of manufacturers' decisions regarding compliance with CAFE standards.

The model also calculates the costs, effects, and benefits of technologies it estimates could be added in response to a given CAFE standard. It calculates costs by applying the cost estimation techniques and by accounting for the number of affected vehicles. It accounts for effects such as changes in vehicle travel, changes in fuel consumption, and changes in greenhouse gas and criteria pollutant emissions. It does so by applying the fuel consumption estimation techniques, the vehicle survival and mileage accumulation forecasts, the rebound effect estimate and the fuel properties and emission factors. Considering changes in travel demand and fuel consumption, the model estimates the monetized value of accompanying benefits to society, as discussed in Chapter VIII. The model calculates both the current (*i.e.*, undiscounted) and present (*i.e.*, discounted) value of these benefits.

The Volpe model has other capabilities that facilitate the development of a CAFE standard. It can be used to fit a mathematical function forming the basis for an attribute-based CAFE standard, following the steps described below. It can also be used to evaluate many (*e.g.*, 200 per model year) potential levels of stringency sequentially, and identify the stringency at which specific criteria are met. For example, it can identify the stringency at which net benefits to society are maximized, the stringency at which a specified total cost is reached, or the stringency at which a given average required fuel economy level is attained. The model can also be used to perform uncertainty analysis (*i.e.*, Monte Carlo simulation), in which input estimates are varied randomly according to specified probability distributions, such that the uncertainty of key measures (*e.g.*, fuel consumption, costs, benefits) can be evaluated.

Nothing in EPCA requires NHTSA to use the Volpe model. In principle, NHTSA could perform all of these tasks through other means. In general, though, these model capabilities greatly increase the agency's ability to rapidly, systematically, and reproducibly conduct key analyses relevant to the formulation and evaluation of new CAFE standards.

What are the attribute-based curves the agencies are using, and how were they developed?

1. Standards are attribute-based and defined by a mathematical function

NHTSA and EPA are setting attribute-based CAFE and CO₂ standards that are defined by a mathematical function for MYs 2012-2016 passenger cars and light trucks. EPCA, as amended by EISA, expressly requires that CAFE standards for passenger cars and light trucks be based on one or more vehicle attributes related to fuel economy, and be expressed in the form of a mathematical function.⁴⁶ The CAA has no such requirement. However, given the advantages of using attribute based standards and given the goal of coordinating and harmonizing CO₂ standards promulgated under the CAA and CAFE standards promulgated under EPCA, as expressed by President Obama in his announcement of the new National Program and in the joint Notice of Inquire, EPA is also proposing to issue standards that are attribute-based and defined by mathematical functions.

Under an attribute-based standard approach, the stringency of the compliance targets for vehicles (and compliance obligations for manufacturers) depends in part on how much of the attribute the vehicles possess. Thus, fuel economy and CO₂ targets are set for individual vehicles, becoming more stringent as the attribute decreases and vice versa. For example, size-based (*i.e.*, size-indexed) standards assign higher fuel economy targets (lower CO₂ targets) to smaller (and generally, but not necessarily, lighter) vehicles and lower fuel economy targets (higher CO₂ targets) to larger (and generally, but not necessarily, heavier) vehicles. The fleet-wide average fuel economy or CO₂ emissions rate that a particular manufacturer must achieve then depends on the size mix of its fleet, *i.e.*, the proportion of the fleet that is small-, medium- or large-sized.

Attribute-based standards are preferable to universal industry-wide average standards for several reasons. First, attribute-based standards increase fuel savings and reduce emissions when compared to an equivalent universal industry-wide standard under which each manufacturer is subject to the same numerical requirement. Absent a policy to require all full-line manufacturers to produce and sell essentially the same mix of vehicles, the stringency of the universal industry-wide standards is constrained by the capability of those full-line manufacturers whose product mix includes a relatively high proportion of larger and heavier vehicles. In effect, the standards are based on the mix of those manufacturers. As a result, the standards are generally set below the capabilities of full-line and limited-line manufacturers that sell predominantly lighter and smaller vehicles and above the capability of limited-line manufacturers that sell predominantly larger and heavier vehicles.

Under an attribute-based system, in contrast, every manufacturer is more likely to be required to continue adding more fuel-saving technology each year because the level of the compliance obligation of each manufacturer is based on its own particular product mix. Thus, the compliance obligation of a manufacturer with a higher percentage of lighter and smaller vehicles will have a higher compliance obligation than a manufacturer with a lower percentage of such vehicles. As a result, all manufacturers must use technologies to enhance the fuel economy levels of the vehicles they sell. Therefore, fuel

⁴⁶ 49 U.S.C. § 32902(a)(3)(A).

savings and CO₂ emissions reductions should be higher under an attribute-based system than under a comparable industry-wide standard.

Second, attribute-based standards minimize the incentive for manufacturers to respond to CAFE and CO₂ standards in ways harmful to safety.⁴⁷ Because each vehicle model has its own target (based on the attribute chosen), attribute-based standards provide no incentive to build smaller vehicles simply to meet a fleet-wide average. Since smaller vehicles are subject to more stringent fuel economy targets, a manufacturer's increasing its proportion of smaller vehicles would simply increase its compliance obligation.

Third, attribute-based standards provide a more equitable regulatory framework for different vehicle manufacturers.⁴⁸ A universal industry-wide average standard imposes disproportionate cost burdens and compliance difficulties on the manufacturers that need to change their product plans and no obligation on those manufacturers that have no need to change their plans. Attribute-based standards spread the regulatory cost burden for fuel economy more broadly across all of the vehicle manufacturers within the industry.

And fourth, attribute-based standards respect economic conditions and consumer choice, instead of having the government mandate a certain fleet mix. Manufacturers are required to invest in technologies that improve the fuel economy of their fleets, regardless of vehicle mix. Additionally, attribute-based standards help to avoid the need to conduct rulemakings to amend standards if economic conditions change, causing a shift in the mix of vehicles demanded by the public. NHTSA conducted three rulemakings during the 1980s to amend passenger car standards for MYs 1986-1989 in response to unexpected drops in fuel prices and resulting shifts in consumer demand that made the passenger car standard of 27.5 mpg infeasible for several years following the change in fuel prices.

We recognize that, because manufacturers' compliance obligations under attribute-based standards are based in part on the mix of vehicles that they produce, the fuel savings and emissions reductions produced under attribute-based standards can vary depending on market conditions. For example, fuel prices lower than those anticipated at the time of rulemaking will tend to shift consumer demand toward larger vehicles. If manufacturers sell more larger vehicles than the agencies anticipate, fuel savings and CO₂ reductions would be lower than anticipated. In contrast, if fuel prices rise significantly, more fuel savings and CO₂ reductions than anticipated should be likely.

Nevertheless, one potential way to mitigate the variability of results under attribute-based standards due to market conditions is through the use of explicit backstops, standards below which manufacturers may not drop. For purposes of the CAFE program, EISA requires a backstop for domestically-manufactured passenger cars—a universal minimum, non-attribute-based standard of either “27.5 mpg or 92 percent of the average fuel economy projected by the Secretary for the combined domestic and non-domestic passenger automobile fleets manufactured for sale in the United States by all manufacturers in the model year...,”⁴⁹ whichever is greater. In the

⁴⁷ The 2002 NAS Report described at length and quantified the potential safety problem with average fuel economy standards that specify a single numerical requirement for the entire industry. See NAS Report at 5, finding 12.

⁴⁸ *Id.* at 4-5, finding 10.

⁴⁹ 49 U.S.C. § 32902(b)(4).

MY 2011 final rule, the first rule setting standards since EISA added the backstop provision to EPCA, NHTSA considered whether the statute permitted the agency to set backstop standards for the other regulated fleets of imported passenger cars and light trucks. Although commenters expressed support both for and against a more permissive reading of EISA, NHTSA concluded in that rulemaking that its authority was likely limited to setting only the backstop standard that Congress expressly provided, *i.e.*, the one for domestic passenger cars.

For purposes of the CAFE and CO₂ standards proposed in this NPRM, NHTSA and EPA recognize that the risk, even if small, does exist that low fuel prices in MYs 2012-2016 might lead indirectly to less than currently anticipated fuel savings and emissions reductions. The NPRM seeks comment on whether backstop standards, or any other method within the agencies' statutory authority, should and can be implemented for the import and light truck fleets in order to achieve the fuel savings that attribute-based standards might not absolutely guarantee.

2. What attribute do the agencies use, and why?

Consistent with the MY 2011 CAFE standards, NHTSA and EPA are proposing to use footprint as the attribute for the MY 2012-2016 CAFE standards and CO₂ emissions standards. There are several policy reasons why the agencies believe that footprint is the most appropriate attribute on which to base the standards, as we discuss below.

In the agencies' judgment, from the standpoint of vehicle safety, it is important that the CAFE and CO₂ standards be set in a way that does not encourage manufacturers to respond by selling vehicles that are in any way less safe. While NHTSA's research also indicates that reductions in vehicle mass tend to compromise vehicle safety, footprint-based standards provide an incentive to use advanced lightweight materials and structures that would be discouraged by weight-based standards, because manufacturers can use them to improve a vehicle's fuel economy without their use necessarily resulting in a change in the vehicle's target level of fuel economy or CO₂ emissions.

Further, although the agencies recognize that weight is better correlated with fuel economy than is footprint, we continue to believe that there is less risk of "gaming" (artificial manipulation of the attribute(s) to achieve a more favorable target) by increasing footprint under footprint-based standards than by increasing vehicle mass under weight-based standards. It is relatively easy for a manufacturer to add enough weight to a vehicle to decrease its applicable fuel economy target a significant amount, as compared to increasing vehicle footprint. The agencies also agree with concerns raised in 2008 by some commenters to NHTSA's MY 2011 CAFE rulemaking that there would be greater potential for gaming under multi-attribute standards, such as standards under which targets would also depend on attributes such as weight, torque, power, towing capability, and/or off-road capability. Standards that incorporate such attributes in conjunction with footprint would not only be significantly more complex, but by providing degrees of freedom with respect to more easily-adjusted attributes, they would make it less certain that the future fleet would actually achieve the average fuel economy and CO₂ reduction levels projected by the agencies.

However, while NHTSA and EPA believe initially that footprint is the most appropriate attribute upon which to base the proposed standards, recognizing strong

public interest in this issue, the NPRM seeks comment on whether the agencies should consider setting standards for the final rule based on another attribute or another combination of attributes. If commenters suggest that the agencies should consider another attribute or another combination of attributes, the agencies specifically request that the commenters address the concerns raised in the paragraphs above regarding the use of other attributes, and explain how standards should be developed using the other attribute(s) in a way that contributes more to fuel savings and CO₂ reductions than the footprint-based standards, without compromising safety.

3. What mathematical function do the agencies use, and why?

The current CAFE standards are defined by a continuous, constrained logistic function, which takes the form of an S-curve, and is defined according to the following formula:

$$TARGET = \frac{1}{\frac{1}{a} + \left(\frac{1}{b} - \frac{1}{a}\right) \frac{e^{(FOOTPRINT-c)/d}}{1 + e^{(FOOTPRINT-c)/d}}}$$

Here, *TARGET* is the fuel economy target (in mpg) applicable to vehicles of a given footprint (*FOOTPRINT*, in square feet), *b* and *a* are the function's lower and upper asymptotes (also in mpg), *e* is approximately equal to 2.718,⁵⁰ *c* is the footprint (in square feet) at which the inverse of the fuel economy target falls halfway between the inverses of the lower and upper asymptotes, and *d* is a parameter (in square feet) that determines how gradually the fuel economy target transitions from the upper toward the lower asymptote as the footprint increases. The following chart shows an example of a logistic target function, where *b* = 20 mpg, *a* = 30 mpg, *c* = 40 square feet, and *d* = 5 square feet:

⁵⁰ *e* is the irrational *number* for which the slope of the function $y = \text{number}^x$ is equal to 1 when x is equal to zero. The first 8 digits of *e* are 2.7182818.

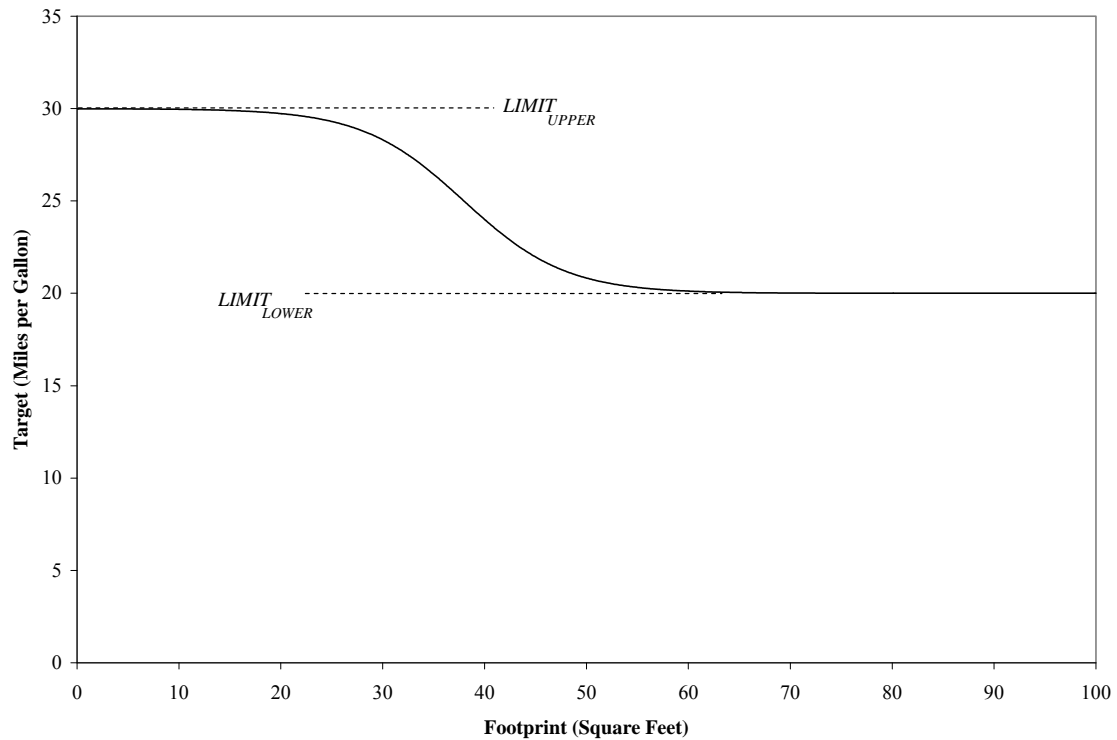
Figure V-1 Sample Logistic Curve

After fitting this mathematical form (separately) to the passenger car and light truck fleets and determining the maximum feasible stringency of the standards (*i.e.*, the vertical positions of the curves), NHTSA arrived at the following curves to define the MY 2011 standards:

Figure V-2 MY 2011 CAFE Standards for Passenger Cars and Light Trucks

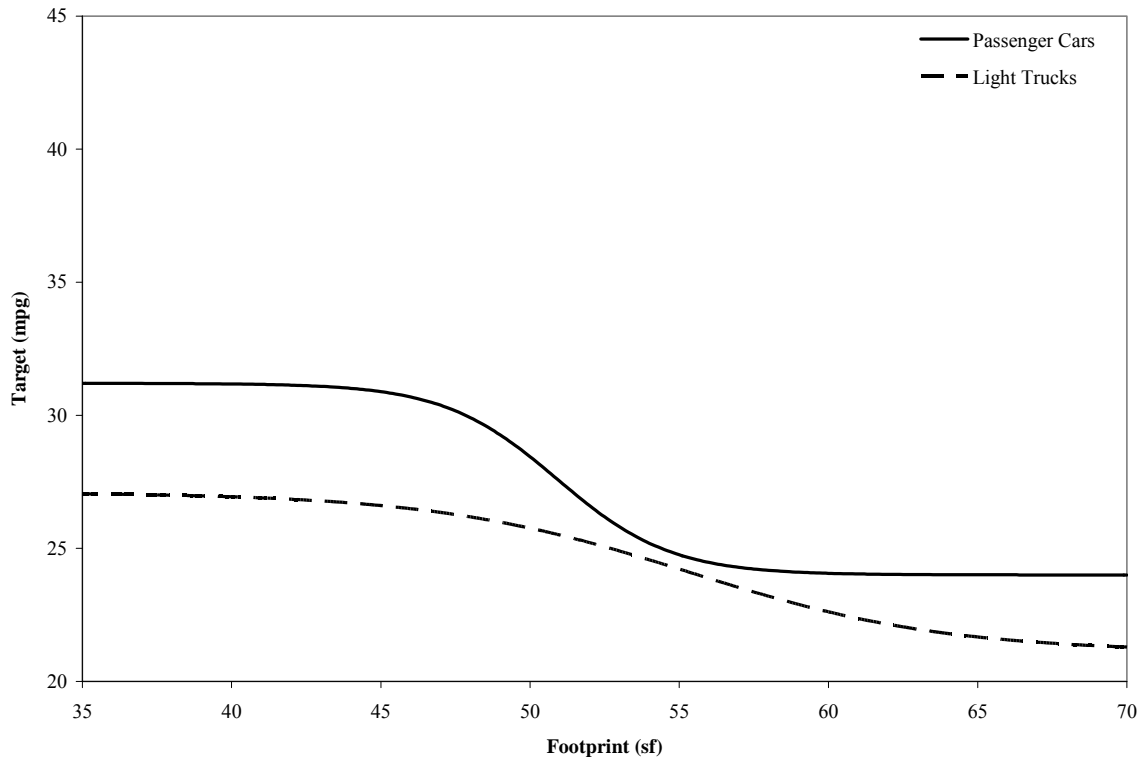

In finalizing the MY 2011 standards, NHTSA noted that the agency is not required to use a constrained logistic function and indicated that the agency may consider defining future CAFE standards in terms of a different mathematical function. NHTSA and EPA have done so jointly in preparation for the proposed CAFE standards and CO₂ emissions standards.

In revisiting this question jointly, NHTSA and EPA found that the final MY 2011 CAFE standard for passenger cars, though less steep than the MY 2011 standard NHTSA proposed in 2008, continues to concentrate the sloped portion of the curve (from a compliance perspective, the area in which upsizing results in a slightly lower applicable target) within a relatively narrow footprint range (approximately 47-55 square feet). Further, most passenger car models have footprints smaller than the curve's 51.4 square foot inflection point, and many passenger car models have footprints at which the curve is relatively flat.

For both passenger cars and light trucks, a mathematical function that has some slope at most footprints where vehicles are produced is advantageous in terms of fairly balancing regulatory burdens among manufacturers, and in terms of providing a disincentive to respond to new standards by downsizing vehicles in ways that compromise vehicle safety. For example, a flat standard may be very difficult for a full-line manufacturer to meet, while requiring very little of a manufacturer concentrating on small vehicles, and a flat standard may provide an incentive to manufacturers to downsize certain vehicles, in order to "balance out" other vehicles subject to the same standard.

As a potential alternative to the constrained logistic function, NHTSA had, in proposing MY 2011 standards, presented information regarding a constrained linear function. As shown in the 2008 NPRM, a constrained linear function has the potential to

avoid creating a localized region (in terms of vehicle footprint) over which the slope of the function is relatively steep. Although NHTSA did not receive public comments on this option, the agency indicated that it still believed a linear function constrained by upper limits (on a gpm basis) and possibly lower limits could merit reconsideration in future CAFE rulemakings.

Having re-examined a constrained linear function for purposes of the proposed standards, NHTSA and EPA tentatively conclude that for both passenger cars and light trucks, it remains meaningfully sloped over a wide footprint range, thereby providing a well-distributed disincentive to downsize vehicles in ways that could compromise highway safety. Also, the constrained linear function proposed today is not so steeply sloped that it would provide a strong incentive to increase vehicle size in order to obtain a lower CAFE requirement and higher CO₂ limit, which would compromise energy and environmental benefits. Therefore, the CAFE and CO₂ emissions standards proposed in the NPRM are defined by constrained linear functions.

The constrained linear function is defined according to the following formula:

$$TARGET = \frac{1}{MIN \left[MAX \left(c \times FOOTPRINT + d, \frac{1}{a} \right), \frac{1}{b} \right]}$$

Here, *TARGET* is the fuel economy target (in mpg) applicable to vehicles of a given footprint (*FOOTPRINT*, in square feet), *b* and *a* are the function's lower and upper asymptotes (also in mpg), respectively, *c* is the slope (in gpm per square foot) of the sloped portion of the function, and *d* is the intercept (in gpm) of the sloped portion of the function (that is, the value the sloped portion would take if extended to a footprint of 0 square feet). The *MIN* and *MAX* functions take the minimum and maximum, respectively of the included values; for example, *MIN*(1,2) = 1, *MAX*(1,2) = 2, and *MIN*[*MAX*(1,2),3]=2. The following chart shows an example of a linear target function, where *a* = 0.0241 gpm (41.6 mpg), *b* = 0.032 gpm (31.2 mpg), *c* = 0.000531 gpm per square foot, and *d* = 0.002292 gpm (436 mpg). Because the function is linear on a gpm basis, not an mpg basis, it is plotted on this basis:

Figure V-3 Sample Linear Function

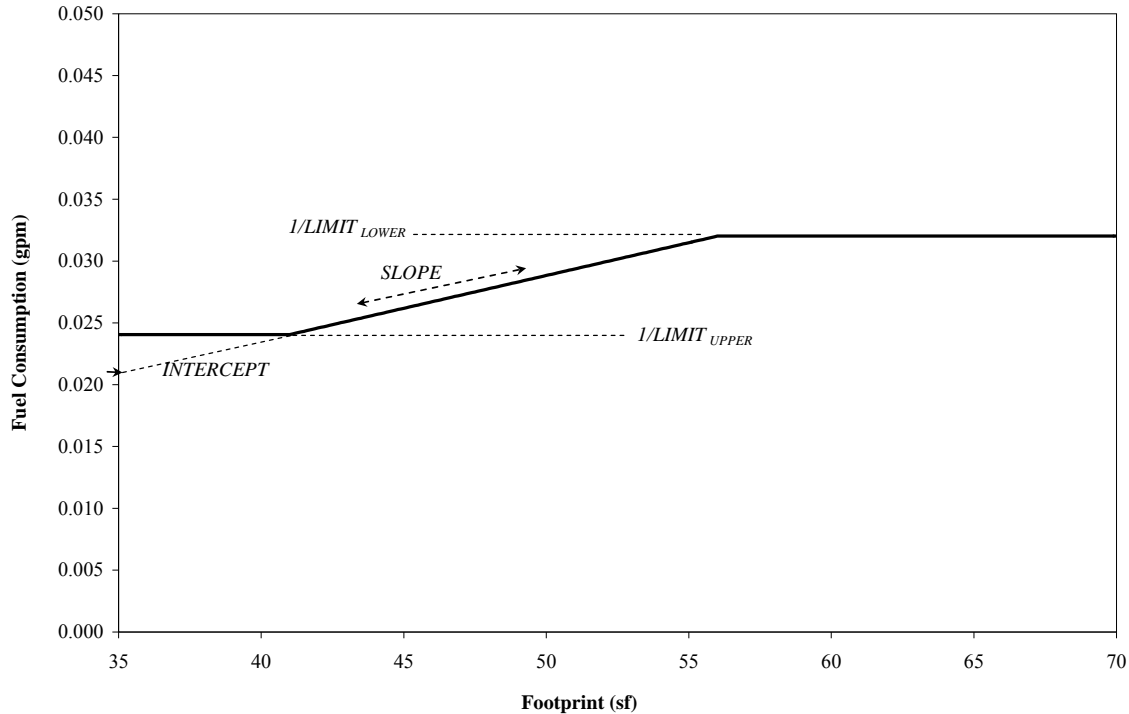

For purposes of the proposed standards, NHTSA, working with EPA, developed the basic curve shapes for both agencies' respective standards, using methods similar to those applied by NHTSA in fitting the curves which define the MY 2011 standards. We began with the market inputs discussed above, but because the baseline fleet is technologically heterogeneous, NHTSA used the CAFE model to develop a fleet to which nearly all the technologies listed in Chapter 3 of the TSD⁵¹ were applied, by taking the following steps: (1) treating all manufacturers as unwilling to pay civil penalties rather than applying technology, (2) applying any technology at any time, irrespective of scheduled vehicle redesigns or freshening, and (3) ignoring "phase-in caps" that constrain the overall amount of technology that can be applied by the model to a given manufacturer's fleet. These steps helped to increase technological parity among vehicle models, thereby providing a better basis (than the baseline fleet) for estimating the statistical relationship between vehicle size and fuel economy.

In fitting the curves, NHTSA and EPA also continued to apply constraints to limit the function's value for both the smallest and largest vehicles. Without a limit at the smallest footprints, the function—whether logistic or linear—can reach values that would be unfairly burdensome for a manufacturer that elects to focus on the market for small

⁵¹ The agencies excluded diesel engines and strong hybrid vehicle technologies from this exercise (and only this exercise) because the agencies expect that manufacturers would not need to rely heavily on these technologies in order to comply with the proposed standards. NHTSA and EPA did include diesel engines and strong hybrid vehicle technologies in all other portions of their analyses.

vehicles; depending on the underlying data, an unconstrained form could apply to the smallest vehicles targets that are simply unachievable. Limiting the function's value for the smallest vehicles ensures that the function remains technologically achievable at small footprints, and that it does not unduly burden manufacturers focusing on small vehicles. On the other side of the function, without a limit at the largest footprints, the function may provide no floor on required fuel economy. Also, the safety considerations that support the provision of a disincentive for downsizing as a compliance strategy apply weakly—if at all—to the very largest vehicles. Limiting the function's value for the largest vehicles leads to a function with an inherent absolute minimum level of performance, while remaining consistent with safety considerations.

Before fitting the sloped portion of the constrained linear form, NHTSA and EPA selected footprints above and below which to apply constraints (*i.e.*, minimum and maximum values) on the function. For passenger cars, the agencies noted that several manufacturers offer small and, in some cases, sporty coupes below 41 square feet, examples including the BMW Z4 and Mini, Saturn Sky, Honda Fit and S2000, Hyundai Tiburon, Mazda MX-5 Miata, Suzuki SX4, Toyota Yaris, and Volkswagen New Beetle. Because such vehicles represent a small portion (less than 10 percent) of the passenger car market, yet often have characteristics that could make it infeasible to achieve the very challenging targets that could apply in the absence of a constraint, the agencies are proposing to “cut off” the linear portion of the passenger car function at 41 square feet. For consistency, the agencies are proposing to do the same for the light truck function, although no light trucks are currently offered below 41 square feet. The agencies further noted that above 56 square feet, the only passenger car model present in the MY 2008 fleet were four luxury vehicles with extremely low sales volumes—the Bentley Arnage and three versions of the Rolls Royce Phantom. The agencies are therefore proposing to “cut off” the linear portion of the passenger car function at 56 square feet. Finally, the agencies noted that although public information is limited regarding the sales volumes of the many different configurations (cab designs and bed sizes) of pickup trucks, the largest pickups (*e.g.*, the Ford F-150, GM Sierra/Silverado, Nissan Titan, and Toyota Tundra) appear to fall above 66 square feet in footprint. The agencies are therefore proposing to “cut off” the linear portion of the light truck function at 66 square feet.

In the NPRM, NHTSA and EPA invite comment on this approach to fitting the curves. The agencies note that final decisions on this issue will play an important role in determining the form and stringency of the final standards, the incentives those standards will provide (*e.g.*, with respect to downsizing small vehicles), and the relative compliance burden faced by each manufacturer.

Having developed a set of data on which to fit the mathematical function, the initial values for parameters C and D were determined for each vehicle type as follows: for a given vehicle type, the initial values of C and D were set at the values for which the average (equivalently, sum) of the absolute values of the differences between the “maximum technology” fleet (within the footprints defining to be used to determine the upper and lower limits) fuel consumption levels for the given vehicle type and the values obtained by applying targets defined by a straight line the function $f(x)$ (defined above) to the corresponding vehicle footprints is minimal. That is, C and D were determined by minimizing the average absolute residual, commonly known as the MAD (Mean Absolute Deviation) approach, of the corresponding straight line. The curve was fit in

fuel consumption space rather than fuel economy space because the manufacturer targets are in terms of the harmonic average fuel economy, and so it is more important that the curve fit the fuel consumption data well than that it fit the fuel economy data well. NHTSA also explained in the MY 2011 final rule that it chose to use MAD in this Step instead of minimizing the sum of the square errors (“least squares,” another common approach in curve fitting) in order to lessen the influence of outliers. NHTSA and EPA believe that it is more appropriate to use unweighted data in fitting the curve rather than weighting the data by sales because of large variations in model sales.

Finally, the agencies calculated the values of the upper and lower constraints based on the corresponding footprints discussed above (41 and 56 square feet for passenger cars, and 41 and 66 square feet for light trucks).

The result of this methodology is shown below in Figures V-4 and V-5 for passenger cars and light trucks, respectively. The fitted curves are shown with the underlying “maximum technology” passenger car and light truck fleets. For passenger cars, the mean absolute deviation of the sloped portion of the function was 14 percent. For trucks, the corresponding MAD was 10 percent.

Figure V-4 “Maximum Technology” Passenger Fleet with Fitted Constrained Linear Function

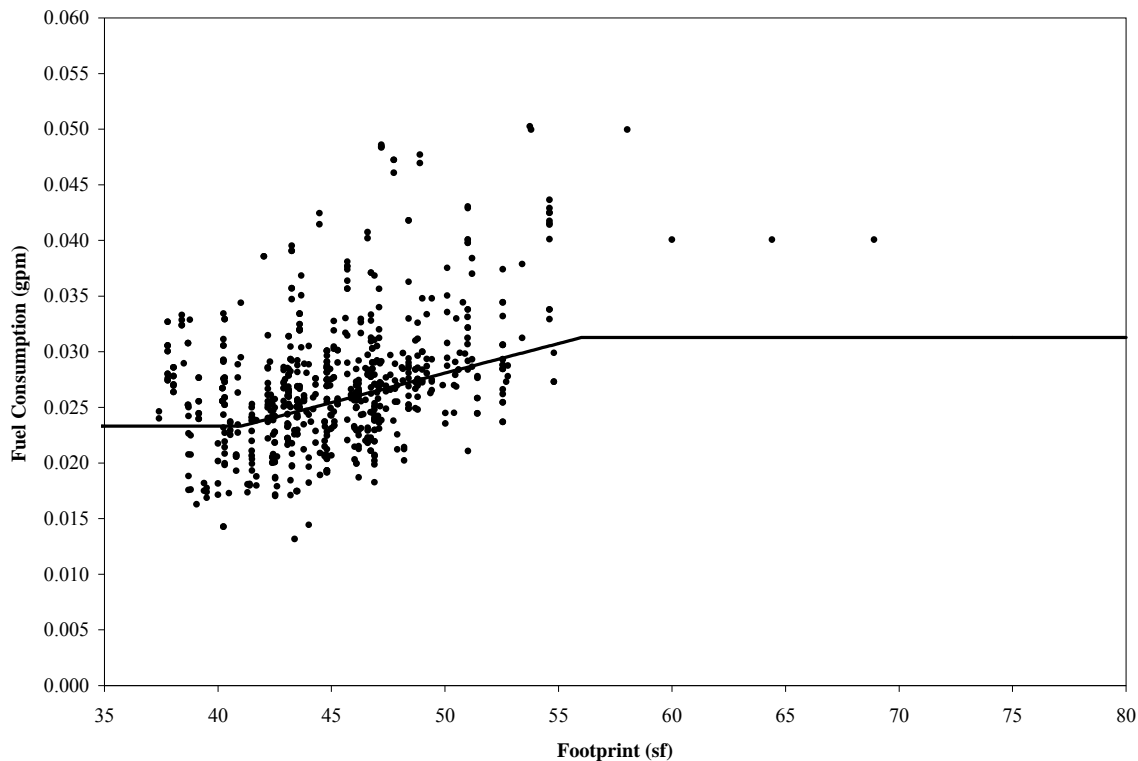
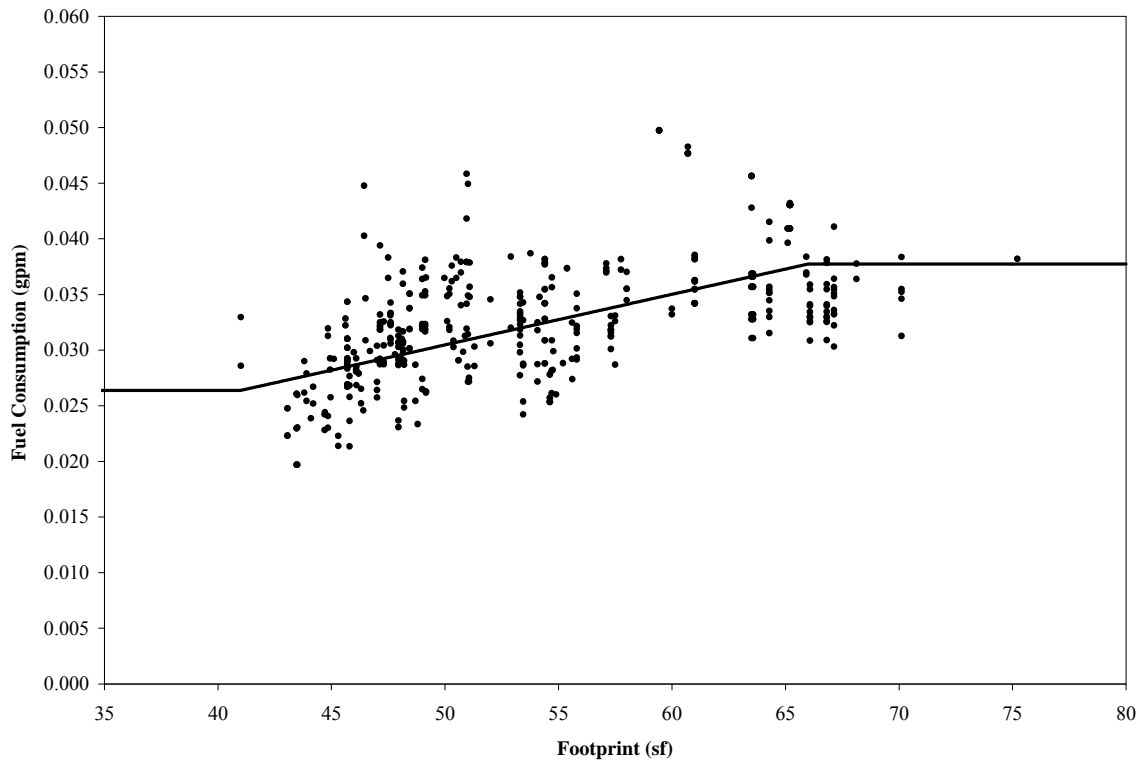

Figure V-5 “Maximum Technology” Light Truck with Fitted Constrained Linear Function



The agencies used these functional forms as a starting point to develop mathematical functions defining actual proposed standards. As discussed in the NPRM preamble, the agencies transposed these functions vertically (*i.e.*, on a gpm basis, uniformly downward) to produce the maximum feasible passenger car and light truck CAFE standards, and corresponding CO₂ emissions standards.

B. How does NHTSA use the assumptions in its modeling analysis?

In developing today’s proposed CAFE standards, NHTSA has made significant use of results produced by the CAFE Compliance and Effects Model (commonly referred to as “the CAFE model” or “the Volpe model”), which DOT’s Volpe National Transportation Systems Center developed specifically to support NHTSA’s CAFE rulemakings. The model, which has been constructed specifically for the purpose of analyzing potential CAFE standards, integrates the following core capabilities:

- (1) estimating how manufacturers could apply technologies in response to new fuel economy standards,
- (2) estimating the costs that would be incurred in applying these technologies,
- (3) estimating the physical effects resulting from the application of these technologies, such as changes in travel demand, fuel consumption, and emissions of carbon dioxide and criteria pollutants, and
- (4) estimating the monetized societal benefits of these physical effects.

An overview of the model follows below. Separate model documentation provides a detailed explanation of the functions the model performs, the calculations it performs in doing so, and how to install the model, construct inputs to the model, and interpret the model's outputs. Documentation of the model, along with model installation files, source code, and sample inputs are available at NHTSA's web site. The model documentation is also available in the docket for today's proposed rule, as are inputs for and outputs from analysis of today's proposed CAFE standards.

1. How does the model operate?

As discussed above, the agency uses the Volpe model to estimate the extent to which manufacturers could attempt to comply with a given CAFE standard by adding technology to fleets that the agency anticipates they will produce in future model years. This exercise constitutes a simulation of manufacturers' decisions regarding compliance with CAFE standards.

This compliance simulation begins with the following inputs: (a) the baseline market forecast, (b) technology-related estimates, (c) economic inputs, and (d) inputs defining the characteristics of potential new CAFE standards. For each manufacturer, the model applies technologies in a sequence that follows a defined engineering logic ("decision trees" discussed in the MY 2011 final rule and in the model documentation) and a cost-minimizing strategy in order to identify a set of technologies the manufacturer could apply in response to new CAFE standards. The model applies technologies to each of the projected individual vehicles in a manufacturer's fleet, until one of three things occurs:

- (1) the manufacturer's fleet achieves compliance with the applicable standard;
- (2) the manufacturer "exhausts"⁵² available technologies; or
- (3) for manufacturers estimated to be willing to pay civil penalties, the manufacturer reaches the point at which doing so would be more cost-effective (from the manufacturer's perspective) than adding further technology.⁵³

As discussed below, the model has also been modified in order to apply additional technology in early model years if doing so will facilitate compliance in later model years.

⁵² In a given model year, the model makes additional technologies available to each vehicle model within several constraints, including (a) whether or not the technology is applicable to the vehicle model's technology class, (b) whether the vehicle is undergoing a redesign or freshening in the given model year, (c) whether engineering aspects of the vehicle make the technology unavailable (*e.g.*, secondary axle disconnect cannot be applied to two-wheel drive vehicles), and (d) whether technology application remains within "phase in caps" constraining the overall share of a manufacturer's fleet to which the technology can be added in a given model year. Once enough technology is added to a given manufacturer's fleet in a given model year that these constraints make further technology application unavailable, technologies are exhausted for that manufacturer in that model year.

⁵³ This possibility was added to the model to account for the fact that under EPCA/EISA, manufacturers must pay fines if they do not achieve compliance with applicable CAFE standards. 49 U.S.C. § 32912(b). NHTSA recognizes that some manufacturers will find it more cost-effective to pay fines than to achieve compliance, and believes that to assume these manufacturers would exhaust available technologies before paying fines would cause unrealistically high estimates of market penetration of expensive technologies such as diesel engines and strong hybrid electric vehicles, as well as correspondingly inflated estimates of both the costs and benefits of any potential CAFE standards.

The model accounts explicitly for each model year, applying most technologies when vehicles are scheduled to be redesigned or freshened, and carrying forward technologies between model years. The CAFE model accounts explicitly for each model year because EPCA requires that NHTSA make a year-by-year determination of the maximum feasible level of average fuel economy and then set the standard at that level, while ensuring ratable increases in average fuel economy.⁵⁴

The model also calculates the costs, effects, and benefits of technologies that it estimates could be added in response to a given CAFE standard.⁵⁵ It calculates costs by applying the cost estimation techniques, and by accounting for the number of affected vehicles. It accounts for effects such as changes in vehicle travel, changes in fuel consumption, and changes in greenhouse gas and criteria pollutant emissions. It does so by applying the fuel consumption estimation techniques, and the vehicle survival and mileage accumulation forecasts, the rebound effect estimate and the fuel properties and emission factors. Considering changes in travel demand and fuel consumption, the model estimates the monetized value of accompanying benefits to society. The model calculates both the undiscounted and discounted value of benefits that accrue over time in the future.

The Volpe model has other capabilities that facilitate the development of a CAFE standard. It can be used to fit a mathematical function forming the basis for an attribute-based CAFE standard, following the steps described below. It can also be used to evaluate many (*e.g.*, 200 per model year) potential levels of stringency sequentially, and identify the stringency at which specific criteria are met. For example, it can identify the stringency at which net benefits to society are maximized, the stringency at which a specified total cost is reached, or the stringency at which a given average required fuel economy level is attained. This allows the agency to compare more easily the impacts in terms of fuel savings, emissions reductions, and costs and benefits of achieving different levels of stringency according to different criteria. The model can also be used to perform uncertainty analysis (*i.e.*, Monte Carlo simulation), in which input estimates are varied randomly according to specified probability distributions, such that the uncertainty of key measures (*e.g.*, fuel consumption, costs, benefits) can be evaluated.

2. Has NHTSA considered other models?

Nothing in EPCA requires NHTSA to use the Volpe model. In principle, NHTSA could perform all of these tasks through other means. For example, in developing the standards proposed today, the agency did not use the Volpe model's curve fitting routines, because they could not be modified in time to reflect the change in the mathematical function defining the proposed CAFE standards. The Volpe model may be modified to do so for the final rule, although the agency can also continue to fit the mathematical function outside the model. In general, though, these model capabilities

⁵⁴ 49 U.S.C. § 32902(a) states that "At least 18 months before the beginning of each model year, the Secretary of Transportation shall prescribe by regulation average fuel economy standards for automobiles manufactured by a manufacturer in that model year. Each standard shall be the maximum feasible average fuel economy level that the Secretary decides the manufacturers can achieve in that year." NHTSA has long interpreted this statutory language to require year-by-year assessment of manufacturer capabilities. 49 U.S.C. § 32902(b)(2)(C) requires that standards increase ratably between MY 2011 and MY 2020.

⁵⁵ As for all of its other rulemakings, NHTSA is required by Executive Order 12866 and DOT regulations to analyze the costs and benefits of CAFE standards. Executive Order 12866, 58 FR 51735 (Oct. 4, 1993); DOT regulations

have greatly increased the agency's ability to rapidly, systematically, and reproducibly conduct key analyses relevant to the formulation and evaluation of new CAFE standards.

During its previous rulemaking, which led to the final MY 2011 standards promulgated earlier this year, NHTSA received comments from the Alliance and CARB encouraging NHTSA to examine the usefulness of other models. As discussed in that final rule, NHTSA, having undertaken such consideration, concluded that the Volpe model is a sound and reliable tool for the development and evaluation of potential CAFE standards.⁵⁶

In reconsidering and reaffirming this conclusion for purposes of this NPRM, NHTSA notes that the Volpe model not only has been formally peer-reviewed and tested through three rulemakings, but also has some features especially important for the analysis of CAFE standards under EPCA/EISA. Among these are the ability to perform year-by-year analysis, and the ability to account for engineering differences between specific vehicle models.

EPCA requires that NHTSA determine the maximum feasible CAFE standards in each model year.⁵⁷ Doing so requires the ability to analyze each model year and, when developing regulations covering multiple model years, to account for the interdependency of model years in terms of what levels of stringency will be the maximum feasible in each one. Also, as part of the evaluation of the economic practicability of the standards, as required by EPCA, NHTSA must assess the annual costs and benefits of the standards. The first (2002) version of DOT's model treated each model year separately, and did not perform this type of explicit accounting. Manufacturers took strong exception to these shortcomings. For example, GM commented in 2002 that "although the table suggests that the proposed standard for MY 2007, considered in isolation, promises benefits exceeding costs, that anomalous outcome is merely an artifact of the peculiar Volpe methodology, which treats each year independently of any other..." In 2002, GM also criticized DOT's analysis for, in some cases, adding a technology in MY 2006 and then replacing it with another technology in MY 2007. GM (and other manufacturers) argued that this completely failed to represent true manufacturer product-development cycles, and therefore could not be technologically feasible or economically practicable.

In response to these concerns, and related concerns expressed by other manufacturers, DOT modified the CAFE model in order to account for dependencies between model years and to better represent manufacturers' planning cycles, in a way that still allowed NHTSA to comply with the statutory requirement to evaluate maximum feasible standards for each model year. This was accomplished by limiting the application of many technologies to model years in which vehicle models are scheduled to be redesigned (or, for some technologies, "freshened"), and by causing the model to "carry forward" applied technologies from one model year to the next.

During the recent rulemaking for MY 2011 passenger cars and light trucks, DOT further modified the CAFE model to account for cost reductions attributable to "learning effects" related to volume (*i.e.*, economies of scale) and the passage of time (*i.e.*, time-based learning), both of which evolve on year-by-year basis. These changes were implemented in response to comments by environmental groups and other stakeholders.

⁵⁶ 74 FR 14372 (Mar. 30, 2009).

⁵⁷ 49 U.S.C. § 32902(a).

The Volpe model is also able to account for important engineering differences between specific vehicle models, and to thereby reduce the risk of applying technologies that may be incompatible with or already present on a given vehicle model. Some commenters have previously suggested that manufacturers are most likely to broadly apply generic technology “packages,” and the Volpe model does tend to form “packages” dynamically, based on vehicle characteristics, redesign schedules, and schedules for increases in CAFE standards. For example, under the proposed CAFE standards for passenger cars, the CAFE model estimated that manufacturers could apply turbocharged SGDI engines mated with dual-clutch AMTs to 1.8 million passenger cars in MY 2016, which amounts to about 16 percent of the MY 2016 passenger car fleet. Recent modifications to the model, discussed below, to represent multi-year planning, increase the model’s tendency to add relatively cost-effective technologies when vehicles are estimated to be redesigned, and thereby increase the model’s tendency to form such packages.

On the other hand, some manufacturers have indicated that, especially when faced with significant progressive increases in the stringency of new CAFE standards, they are likely to also look for narrower opportunities to apply specific technologies. By progressively applying specific technologies to specific vehicle models, the CAFE model also produces such outcomes. For example, under the proposed CAFE standards for passenger cars, the CAFE model estimated that in MY 2012, some manufacturers could find it advantageous to apply SIDI to some vehicle models without also adding turbochargers.

By following this approach of combining technologies incrementally and on a model-by-model basis, the CAFE model is able to account for important engineering differences between vehicle models and avoid unlikely technology combinations. For example, the model does not apply dual-clutch AMTs (or strong hybrid systems) to vehicle models with 6-speed manual transmissions. Some vehicle buyers prefer a manual transmission; this preference cannot be assumed away. The model’s accounting for manual transmissions is also important for vehicles with larger engines: for example, cylinder deactivation cannot be applied to vehicles with manual transmissions, because there is no reliable means of predicting when the driver will change gears. By retaining cylinder deactivation as a specific technology rather than part of a pre-determined package and by retaining differentiation between vehicles with different transmissions, DOT’s model is able to target cylinder deactivation only to vehicle models for which it is technologically feasible.

The Volpe model also produces a single vehicle-level output file that, for each vehicle model, shows which technologies were present at the outset of modeling, which technologies were superseded by other technologies, and which technologies were ultimately present at the conclusion of modeling. For each vehicle, the same file shows resultant changes in vehicle weight, fuel economy, and cost. This provides for efficient identification, analysis, and correction of errors, a task with which the public can now assist the agency, since all inputs and outputs are public.

Such considerations, as well as those related to the efficiency with which the Volpe model is able to analyze attribute-based CAFE standards and changes in vehicle classification, and to perform higher-level analysis such as stringency estimation (to meet predetermined criteria), sensitivity analysis, and uncertainty analysis, lead the agency to

conclude that the model remains the best available to the agency for the purposes of analyzing potential new CAFE standards.

3. What changes has DOT made to the model?

Prior to being used for analysis supporting today's proposal, the Volpe model was revised to make some minor improvements, and to add one significant new capability: the ability to simulate manufacturers' ability to engage in "multi-year planning." Multi-year planning refers to the fact that when redesigning or freshening vehicles, manufacturers can anticipate future fuel economy or CO₂ standards, and add technologies accounting for these standards. For example, a manufacturer might choose to over-comply in a given model year when many vehicle models are scheduled for redesign, in order to facilitate compliance in a later model year when standards will be more stringent yet few vehicle models are scheduled for redesign.⁵⁸ Prior comments have indicated that the Volpe model, by not representing such manufacturer choices, tended to overestimate compliance costs. However, because of the technical complexity involved in representing these choices when, as in the Volpe model, each model year is accounted for separately and explicitly, the model could not be modified to add this capability prior to the statutory deadline for the MY 2011 final standards.

The model now includes this capability, and NHTSA has applied it in analyzing the standards proposed today. Consequently, this often produces results indicating that manufacturers could over-comply in some model years (with corresponding increases in costs and benefits in those model years) and thereby "carry forward" technology into later model years in order to reduce compliance costs in those later model years. NHTSA believes this better represents how manufacturers would actually respond to new CAFE standards, and thereby produces more realistic estimates of the costs and benefits of such standards.

The Volpe model has also been modified to accommodate inputs specifying the amount of CAFE credit to be applied to each manufacturer's fleet. Although the model is not currently capable of estimating manufacturers' decisions regarding the generation and use of CAFE credits, and EPCA does not allow NHTSA, in setting CAFE standards, to take into account manufacturers' potential use of credits, this additional capability in the Volpe model provides a basis for more accurately estimating costs, effects, and benefits that may actually result from new CAFE standards. Insofar as some manufacturers actually do earn and use CAFE credits, this provides NHTSA with some ability to examine outcomes more realistically than EPCA allows for purposes of setting new CAFE standards.

In comments on recent NHTSA rulemakings, some reviewers have suggested that the Volpe model should be modified to estimate the extent to which new CAFE standards would induce changes in the mix of vehicles in the new vehicle fleet. NHTSA agrees that a "market shift" model could provide useful information regarding the possible effects of potential new CAFE standards. An earlier experimental version of the Volpe model included a multinomial logit model that estimated changes in sales resulting from CAFE-induced increases in new vehicle fuel economy and prices. However, the agency has thus far been unable to develop credible coefficients specifying such a model. If the

⁵⁸ Although a manufacturer may, in addition, generate CAFE credits in early model years for use in later model years (or, less likely, in later years for use in early years), EPCA does not allow NHTSA, when setting CAFE standards, to account for manufacturers' use of CAFE credits.

agency is able to do so prior to conducting analysis supporting decisions regarding final CAFE standards, it will attempt to reintegrate this capability in the Volpe model and include these effects in its analysis of final standards. If not, NHTSA will continue efforts to develop and make use of this capability in future rulemakings.

4. Does the model set the standards?

Although NHTSA currently uses the Volpe model as a tool to inform its consideration of potential CAFE standards, the Volpe model does not determine the CAFE standards that NHTSA proposes or promulgates as final regulations. The results it produces are completely dependent on inputs selected by NHTSA, based on the best available information and data available in the agency's estimation at the time standards are set. In addition to identifying the input assumptions underlying its decisions, NHTSA provides the rationale and justification for selecting those inputs. NHTSA also determines whether to use the model to estimate at what stringency net benefits are maximized, or to estimate other stringency levels, such as those that produce constant rates of increase in the combined average required fuel economy. Finally, NHTSA is guided by the statutory requirements of EPCA as amended by EISA in the ultimate selection of a CAFE standard.

NHTSA considers the results of analyses conducted by the Volpe model and analyses conducted outside of the Volpe model, including analysis of the impacts of carbon dioxide and criteria pollutant emissions, analysis of technologies that may be available in the long term and whether NHTSA could expedite their entry into the market through these standards, and analysis of the extent to which changes in vehicle prices and fuel economy might affect vehicle production and sales. Using all of this information—not solely that from the Volpe model—the agency considers the governing statutory factors, along with environmental issues and other relevant societal issues such as safety, and promulgates the maximum feasible standards based on its best judgment on how to balance these factors.

This is why the agency considered eight regulatory alternatives, only one of which reflects the agency's proposed standards, based on the agency's determinations and assumptions. Others assess alternative standards, some of which exceed the proposed standards and/or the point at which net benefits are maximized. These comprehensive analyses, which also included scenarios with different economic input assumptions as presented in the FEIS and FRIA, are intended to inform and contribute to the agency's consideration of the "need of the United States to conserve energy," as well as the other statutory factors. 49 U.S.C. § 32902(f). Additionally, the agency's analysis considers the need of the nation to conserve energy by accounting for economic externalities of petroleum consumption and monetizing the economic costs of incremental CO₂ emissions in the social cost of carbon. NHTSA uses information from the model when considering what standards to propose and finalize, but the model does not determine the standards.

5. How does NHTSA make the model available and transparent?

Model documentation, which is publicly available in the rulemaking docket and on NHTSA's web site, explains how the model is installed, how the model inputs (all of which are available to the public)⁵⁹ and outputs are structured, and how the model is

⁵⁹ We note, however, that files from any supplemental analysis conducted that relied in part on confidential manufacturer product plans cannot be made public, as prohibited under 49 CFR Part 512.

used. The model can be used on any Windows-based personal computer with Microsoft Office 2003 and the Microsoft .NET framework installed (the latter available without charge from Microsoft). The executable version of the model and the underlying source code are also available at NHTSA's web site. The input files used to conduct the core analysis documented in this proposed rule are available in the public docket. With the model and these input files, anyone is capable of independently running the model to repeat, evaluate, and/or modify the agency's analysis.

Estimating Market Effects Induced by New CAFE Standards

As discussed in the *Federal Register* notice supported by this PRIA, NHTSA believes that a "market shift" model could provide useful information regarding the possible effects of potential new CAFE standards. An earlier experimental version of the Volpe model included a multinomial logit model that estimated changes in sales resulting from CAFE-induced increases in new vehicle fuel economy and prices, as well as an accompanying cost allocation algorithm to estimate how manufacturers might allocate compliance costs. However, the agency has thus far been unable to develop credible coefficients specifying such a model. The agency intends to continue seeking to develop such methods, and documents its prior attempts here in the interest of providing an overview of how they might be formulated and applied. The following description applies to an earlier experimental version of the Volpe model, not to the current version of the model. The latter does not have the capabilities discussed below.

1. Cost Allocation Assumptions

At the compliance simulation's conclusion, each represented vehicle model has some incurred technology cost (potentially zero), and each represented manufacturer has some zero or positive incurred CAFE fines (*i.e.*, civil penalties). We consider several cost allocation assumptions to distribute these compliance costs across each manufacturer's product line, following one of the following four strategies as specified as a user input for each manufacturer:

As-Incurred: Based on the total technology costs incurred by each vehicle.

Price-Based: Based on the initial price (MSRP) of each vehicle.

Elasticity-Based: Based on the inverse of each vehicle's price elasticity of demand.

Uniform: Based on uniform allocation across all vehicles.

A review of relevant literature did not reveal published studies that focus specifically on the relationship between CAFE compliance costs and vehicle prices. However, this review did reveal studies that generically address automotive price elasticities of demand and their influence on pricing decisions, as well as production costs and pricing strategies

for some categories of automotive powertrain components.⁶⁰ Interviews with selected industry experts suggest that manufacturers may shift compliance costs between vehicle models in order to maintain or improve competitiveness in profitable market segments. Specific information regarding the pricing strategies followed by individual manufacturers is unavailable.⁶¹ The pricing strategies provided by the cost allocation assumption portion of the model are intended to realistically bracket the potential range of strategies.

At the conclusion of the cost allocation assumption part of the system, each vehicle model is assigned a regulatory cost, which is reported as a price increase and used when applying the market share model discussed below.

Market Share Model

To provide the capability to analyze the market response to changes in vehicle prices and other attributes resulting from manufacturers' efforts to comply with CAFE regulation, we developed a statistical model to analyze the factors influencing new car buyers' choices among vehicle models. Our model focuses on buyers' decisions to choose specific vehicle types individual models, but does not analyze the factors influencing their choices to purchase a new vehicle during a specific model year.

Market Share Model Structure

The model uses a nested logit model to represent buyers' decisions about the type of vehicle to purchase and their choices among competing models of that type. As **Error! Reference source not found.**V-6 illustrates, buyers are assumed to make decisions using a two-step process. First, a consumer chooses a type of vehicle, for example, a mid-size premium automobile, a small pickup truck, or a large sport-utility vehicle.⁶² Conditioned on that decision, a buyer then selects an individual vehicle model from among those making up the chosen "market segment".

⁶⁰ [Pickrell and Hassol: add references]

⁶¹ [Pickrell and Hassol: add references]

⁶² Our model employs the market segmentation presented in *2002 Automotive News Car Market Classifications*, [need website address]

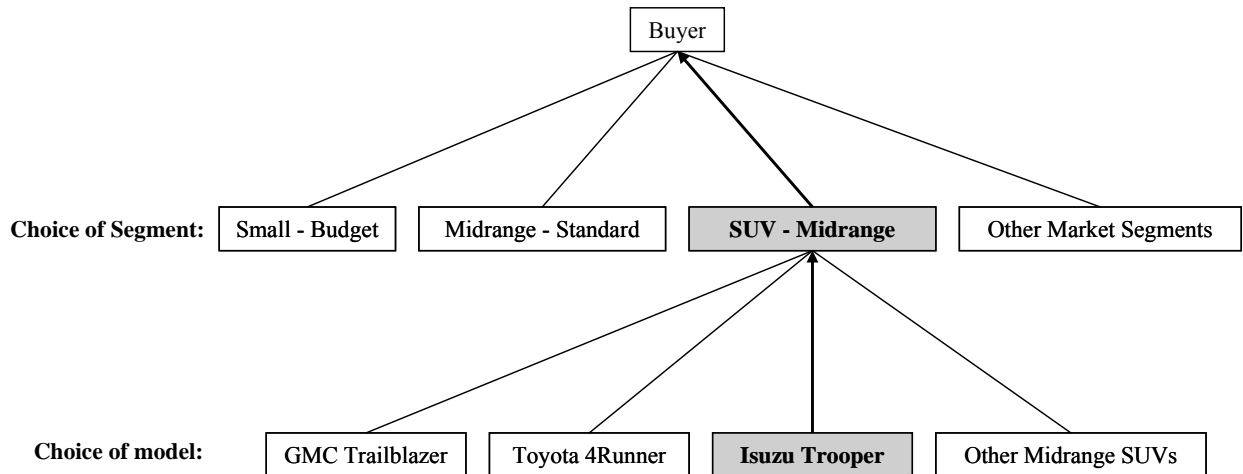

Figure V-6. Nested Logit Model

This model relies on several underlying assumptions; most important, that buyers derive utility from the attributes offered by different vehicle models, including characteristics such as its passenger- and cargo-carrying capacity, driving performance, fuel economy, comfort level, transmission and drive type (two- versus four-wheel drive). Individual buyers are assumed to choose the specific vehicle model whose purchase price and combination of attributes offers the maximum level of utility. Many of the attributes or characteristics that make individual vehicle models attractive to potential buyers have been well documented, and some of these can be readily measured and compared.

However, other characteristics that lead buyers to view particular models as closely competitive may be difficult to quantify, or may simply be unknown. The presence of these unobserved attributes means that vehicles are likely to form groups or market segments, and that models within each segment compete more closely with one another than with models belonging to other market segments. Our model uses the common assumption in automotive marketing that market segments consist of vehicle models of similar body type or style, overall size, luxury level, and performance.

Factors Affecting Vehicle Buyer's Behavior

Using the subscript s to designate market segments, k to designate individual vehicle models, and n to designate buyers, the probability that a representative buyer will choose a vehicle of type and luxury or performance level s is simply

$$P_n(s) \quad (0.1)$$

In turn, the probability that buyer n will choose to purchase a specific brand and model k from within market segment, or $P_n(sk)$, is

$$P_n(sk) = P_n(k|s)P_n(s) \quad (0.2)$$

Here, $P_n(k|s)$ represents the conditional probability that the representative buyer will select model k , having already decided to purchase a vehicle of the body type and luxury or performance level represented by segment s .

In choosing a market segment and a specific vehicle model, the probability that a buyer will choose a specific alternative depends on how the utility or benefits it provides compare to those supplied by the competing choices. Since buyers are assumed to choose the alternative that offers the maximum utility, the likelihood that any specific alternative will be chosen depends on the probability that it offers the maximum utility level among the choices available.

For example, the probability that a buyer will select a specific vehicle model from a given market segment depends on how the utility its attributes offer compares to the utility levels offered by other vehicle models within that same market segment. Similarly, a buyer's choice of the vehicle type, size, luxury, and performance level to shop for depends on how the composite utility of the various models making up that market segment compares to the composite utility offered by the vehicles included in the other market segments.

The observable or measurable component of utility offered by each vehicle model depends on the particular features or attributes it provides, such as its driving performance, fuel economy, and seating or luggage-carrying capacity, as well as on its purchase price.⁶³ The unobserved component of utility that each model offers arises partly from uncertainty about which observable attributes are important to buyers, as well as about the relationship between a vehicle's combination of attributes and the utility it offers to prospective buyers. Other sources of unobserved utility include errors in measuring or describing these attributes, and the potential existence of attributes that, though valued by buyers, are unknown or difficult to measure.

<http://www.epa.gov/QUALITY/informationguidelines/>

By making a specific assumption about the probability distribution of these unobserved components of utility, the probability that a representative buyer will select a specific vehicle model can be expressed as a function of the utility it's measured attributes supply and of how it compares to the utility levels offered by competing models.⁶⁴ One common assumption is that the unobserved components of utility follow a specific probability distribution in which large values are rare (a Type I extreme value distribution, which somewhat resembles a normal distribution), and are thus unlikely to be sufficiently large to offset any difference in observed utilities between the preferred model and other competing choices.

⁶³ It may also be affected by characteristics of the buyers who choose the market segment containing that model, since certain characteristics of buyers may affect their preferences for or valuation of specific vehicle attributes.

⁶⁴ The specific probability distribution assumed for the unobserved utility components determines the form of the expression for the probability that an individual model will be chosen, because it determines the probability that a vehicle model offering the maximum observed or measured level of utility to a buyer would still represent that buyer's utility-maximizing choice if the unobserved component of utility were also reflected in the decision.

Under this assumption, the probability that a representative buyer will purchase a vehicle model (k) from among those within a market segment (s) is an exponential function of its utility as well as those offered by the other models in that market segment:

$$P_n(k|s) = \frac{e^{U_{sk}}}{\sum_{k' \in s} e^{U_{sk'}}} \quad (0.3)$$

where U_{sk} represents the level of utility provided by the attributes of vehicle model k . In turn, the probability that a representative buyer will decide to purchase a vehicle from market segment s can be expressed as

$$P_n(s) = \frac{e^{\mu^s U_s}}{\sum_{s' \in s} e^{\mu^s U_{s'}}} \quad (0.4)$$

where

$$U_s = \log\left(\sum_{k' \in s} e^{U_{sk'}}\right) \quad (0.5)$$

The term $\sum_{k' \in s} e^{U_{sk'}}$, often referred to as the *expected maximum utility* provided by the choices available in market segment s , is a measure of the composite utility – *i.e.*, the overall attractiveness to potential buyers – offered by all of the vehicle models making up that market segment. Thus, Equation (0.4) states that the probability a buyer will purchase a vehicle from market segment s – say a small economy car – depends on how the composite utility (or combined attractiveness) of the models making up that category compares to the composite utility measures for each of the other market segments (sports cars, large automobiles, midsize sport-utility vehicles, etc.), the sum of which appears in the denominator.

Equation (0.4) also shows that the expected maximum utility of each market segment is scaled by the parameter μ^s , which measures the variance in the unobserved component of utility shared by models in the same market segment relative to that of the remaining unobserved component of utility, which differs for each vehicle model. This parameter (sometimes referred to as the nesting coefficient) has the convenient property that the value of $[1 - (\mu^s)^2]$ measures how similarly buyers view the various vehicle models included within each market segment, thus indicating how closely the market segmentation used in the model matches shoppers' views of model groupings or segmentation in the new vehicle market.⁶⁵

⁶⁵ Specifically, $[1 - (\mu^s)^2]$ measures the correlation between the utility levels offered by any two vehicle models that are included in the same market segment. The value of μ^s is theoretically restricted to the range from 0 to 1; values close to 0 indicate that the utilities offered by models in the same market segment are closely correlated, and thus that the market segmentation used in the model accurately reflects buyers' views about how closely different vehicle types and models compete with one another. In contrast, values

Our model assumes that the utility offered by an individual vehicle model is a linear function of the levels of various attributes that it offers, including its driving performance, seating capacity, fuel economy, transmission and drive type, and its purchase price. Denoting these attributes X_1, X_2, \dots, X_n , vehicle model k within market segment s provides a utility level

$$U_{sk} = \beta_1 X_{1k} + \beta_2 X_{2k} + \dots + \beta_n X_{nk} + \varepsilon_s + \varepsilon_{sk} \quad (0.6)$$

where, for example, X_{1k} denotes the level of attribute 1 – say, the ratio of horsepower to weight, a widely used index of driving performance – provided by vehicle model k .⁶⁶

The relative importance or weight that buyers attach to each vehicle attribute is summarized by the value of its coefficient ($\beta_1, \beta_2, \dots, \beta_n$), while the terms ε_s and ε_{sk} respectively represent the unobserved components of utility shared by all vehicles in market segment s and unique to vehicle model k . As discussed previously, it is the presence of the term ε_s , which represents the unobserved component of utility that is shared by all vehicle models in market segments, that implies the hierarchical structure of buyers' decisions.

Statistical Estimation of Model Parameters

Parameters specified in an input file define this model based on any of several candidate attributes. These parameters can be estimated statistically by using the market shares of total sales accounted for by each individual vehicle model during a recent model year to approximate the probabilities that a “typical” vehicle buyer would choose each model. We estimated the model's parameters, including the coefficients ($\beta_1, \beta_2, \dots, \beta_n$) in Equation (0.6) and the nesting parameter μ^s , using market share and attribute data for the approximately 1,300 automobile and light truck models that were produced and sold during model year 2002. Total automobile and light truck sales during that model year were about 17 million vehicles.

We assembled data on suggested retail and actual sales prices, horsepower, vehicle weight, seating capacity, fuel economy, fuel tank capacity, transmission and drive type, continent of origin, and brand name for each vehicle model produced and sold during model year 2002. These attributes were used to define additional vehicle characteristics such as the ratio of horsepower to vehicle weight and refueling range, and the resulting set of attributes was used to test a variety of different specifications for Equation (0.6).

Using the Market Share Model

closer to 1 indicate that the utilities of models in the same segment are not closely correlated, and thus that the market segmentation may be inaccurate.

⁶⁶ Thus in this model, the parameter μ^s in Equation (0.4) measures the variance in ε_s relative to the variance in ε_{sk} .

With a sufficiently large number of new vehicle sales, the model's predicted probabilities that a representative buyer will choose each vehicle model can be interpreted as the share or fraction of total sales it is likely to account for. Thus the model can be used to estimate how the market shares of individual vehicle models would have differed during that period if one or more attributes of a specific model had been different. If data describing the attributes and prices of vehicles that manufacturers will offer for sale during future model years are available, this model can also be used to simulate how sales or market shares in future years would change in response to changes in attributes or prices for some models.

The change in the probability that an individual vehicle model k would have been chosen by a representative buyer – or in the aggregate, its market share of total new vehicle sales – in response to a change in one of its attributes $X_{i,k}$ is:

$$\begin{aligned} \frac{\partial P_n(sk)}{\partial X_{i,k}} &= \frac{\partial P_n(k|s)}{\partial X_{i,k}} + \frac{\partial P_n(s)}{\partial X_{i,k}} \\ &= \beta_i P_n(k|s) [1 - P_n(k|s)] P_n(s) + \mu^s \beta_i P_n(k|s)^2 P_n(s) [1 - P_n(s)] P_n(s) \end{aligned} \quad (0.7)$$

Normalizing Equation (0.7) to measure the proportional (rather than absolute) change in a vehicle's market share in response to a proportional change in one of its attributes gives the elasticity of its market share:

$$\frac{\partial P_n(sk)}{\partial X_{i,k}} \left[\frac{X_{i,k}}{P_n(sk)} \right] = \beta_i X_{i,k} [1 - P_n(k|s)] + \mu^s \beta_i X_{i,k} P_n(k|s) [1 - P_n(s)] \quad (0.8)$$

The computed values of these elasticities, which depend on the estimated parameters (the β_i s), the values of the attributes that change (the $X_{i,k}$ s), and the initial market shares of individual vehicles (the values of P_{sk}), can be used in two ways. First, the elasticities of vehicle models' market shares with respect to their own selling prices can be used to implement the cost-sharing calculation that apportions a manufacturer's technology costs for improving the fuel economy of its fleet in inverse proportion to the price elasticity of demand for each of its models. Second, they can be used to estimate the resulting changes in market shares for individual models that results when these technology costs are "spread" among a manufacturer's fleet using this or any other cost allocation assumption.

However, certain attributes of at least some vehicle models – notably fuel economy, and possibly weight and performance – will also change as part of manufacturers' efforts to comply with stricter fuel economy standards. When prices and other attributes of a number of vehicle models change simultaneously, it is often simpler to estimate the new market shares that will result by inserting the changed prices and attribute values in the utility expression for these models and recalculate the new market shares of all models directly.

These new market shares can then be used to recalculate how each manufacturer's sales-weighted CAFE level would have changed once the technology costs for improving some of its models' fuel economy were reflected in vehicle prices. This revised CAFE level can then be used to assess each manufacturer's compliance with the revised standard, and thus its need to apply additional fuel economy technology to its vehicle models.

NML (Market Share) Model Specification

The system uses a 2-level nested multinomial logit (NML) model to recalculate market shares and sales volumes of different vehicle models after compliance costs have been estimated and allocated. Table V-1 lists the attributes accommodated by the system, and shows the inclusive value parameter the coefficients used in Equation (0.6) for a sample model using price and four other attributes. Other NML formulations may be specified, subject to the following constraints:

- The inclusive value parameter must be between 0 and 1.
- Coefficients must apply to attributes measured in the indicated units.
- The number of market segments must correspond to the vehicles input file.

Table V-1. Market Share Model Coefficients (Sample)

Inclusive Value Parameter		0.579638
Attribute	Units	Coefficient
Effective Price	dollars (2003)	-0.000061
Fuel Economy	mpg	
Seating Capacity (Max.)	number of seat belts	0.175729
Curb Weight	pounds	
4 Wheel Drive	1=present	0.075382
Automatic Transmission	1=present	
Power	horsepower	
Power/Weight	horsepower/pound	10.046800
Range	miles	
Weight-Specific Fuel Economy	pound-miles per gallon	

When developing an input file defining the initial state of the MY2002 fleet based on the structure shown in Table V-1 we estimated the annual sales volumes for the 1,355 individual vehicle models produced during model year 2002 using production data reported to NHTSA by manufacturers for the purpose of determining their CAFE compliance, supplemented with confidential and commercial data regarding vehicles with curb weights over 8,500 pounds.

As discussed above, we developed the vehicle attribute, price, and other data used to estimate the market share model using several sources. We initially obtained some vehicle attribute data through information requests to the automotive manufacturers, but because of inconsistent reporting the resulting data file was missing some or all attribute data for certain vehicle models. Wherever possible, we filled these gaps by collecting supplemental information from online sources of vehicle characteristics and related data such as Edmunds.com. As part of this process, we also obtained the Manufacturer's Suggested Retail Price (MSRP) for each vehicle model produced during model year 2002.

Because actual purchase prices for most vehicle models typically differ significantly from their suggested retail process, we adjusted each vehicle model's MSRP for model year 2002 by the ratio of its nationwide average "True Market Value" (TMV) during model year 2004, as estimated by Edmunds.com, to its MSRP during model year 2004.⁶⁷ This adjustment provided an estimate of its nationwide average actual selling price during model year 2002. For vehicle models produced in model year 2002 but no longer offered for sale during model year 2004, we used the ratio of Edmunds' estimated TMV to MSRP for the vehicle model in the same market segment we judged to be most similar (and where possible, produced by the same manufacturer).

⁶⁷ Edmunds' estimates of vehicles True Market Values for model year 2002 were no longer available at the time we developed the market share model.

To calculate an “effective price” that takes into account fuel costs, we combined this with the estimated value to the consumer of fuel outlays during a specific payback period. We calculated this value using the same methodology used in the compliance simulation model. The model-specific form applied here is as follows:

$$VALUE_{FUEL} = \sum_{v=0}^{v=PB} \frac{SURV_v MI_v FUELPRICE_{MY+v}}{FE(1-gap)(1+r)^{v+0.5}} \quad (0.9)$$

where MI_v is the number of miles driven during the year when a vehicle produced in model year MY reaches age v , $SURV_v$ is the probability that a vehicle of that vintage (model year) will remain in service through age v , FE is the vehicle’s fuel economy, $FUELPRICE_{MY+v}$ is the price of fuel in year $MY+v$, and PB is a “payback period”, or number of years in the future the consumer is assumed to take into account when considering fuel savings. Payback periods of three and five years produced similar results.

Table V-2 lists the vehicle attributes for which we were able to obtain complete data using the combination of sources discussed above. We used the estimated market shares and attribute data for individual vehicle models to develop a two-level nested logit model of each vehicle model’s market share. In this model, buyers first choose one of the 23 market segments developed by Automotive News to represent the new vehicle market, each of which represents one combination of vehicle type (automobile versus light truck), style (*e.g.*, sedan, pickup, or utility vehicle), size (small, mid-size, or large), and luxury level (standard, “upscale,” etc.). Table V-2 gives examples of vehicles that fall into each of these segments.⁶⁸ Buyers then choose to purchase one of the specific vehicle models within that market segment.

⁶⁸ When using forward-looking product plans, it will be necessary to assign each new vehicle model to one of these market segments.

Table V-2. NML Market Segments and Example Vehicles

Segment	Name	Examples
1	Small - Budget	Hyundai Accent, Toyota Echo
2	Small - Economy	Dodge Neon, Saturn S Series, Toyota Corolla
3	Sporty - Touring	Mazda Miata, Toyota MR2 Spyder, Mini Cooper
4	Sporty - Premium	Audi TT Coupe, Porsche (all), BMW Z3
5	Sporty - Exotic	Ferrari (all), Lotus Esprit, Dodge Viper
6	Mid-Range - Lower	Chevrolet Malibu, Honda Civic, VW Golf
7	Mid-Range - Standard	Buick Century, Toyota Camry, Honda Accord
8	Mid-Range - Premium	Audi A4, Nissan Maxima, Saab 9-3
9	Traditional	Buick LeSabre, Ford Crown Victoria, Toyota Avalon
10	Upscale - Near Luxury	Acura TL, BMW 3-Series, Volvo 70 Series, Chrysler 300M
11	Upscale - Luxury	Acura RL, BMW 5-Series, Jaguar XJ, Mercedes-Benz E Class
12	Upscale - Premium	Bentley (all), Mercedes-Benz CL600, Rolls-Royce
13	Pickups - Small	Chevrolet S, Dodge Dakota, Mazda B-Series
14	Pickups - Full-Sized	Dodge Ram, Ford F-Series, Toyota Tundra
15	Vans - Mini	Honda Odyssey, Toyota Sienna, Dodge Caravan
16	Vans - Full-Sized	Chevrolet Express, Dodge Ram Van, Ford Econoline
17	SUV - Standard Sport Wagon	Honda CRV, Ford Escape, Toyota Highlander
18	SUV - Premium Sport Wagon	Acura MDX, BMW X5, Mercedes-Benz M-Class
19	SUV - Small	Chevrolet Tracker, Jeep Liberty, Nissan Xterra
20	SUV - Mid-Range	Chevrolet Trailblazer, Dodge Durango, Honda Passport
21	SUV - Large	Chevrolet Suburban, Ford Expedition, Toyota Sequoia
22	SUV - Premium	Cadillac Escalade, Land Rover Range Rover, Mercedes-Benz G Class, Lincoln Navigator
23	SUV - Sport-utility pickups	Chevrolet Avalanche, Lincoln Blackwood, Cadillac Escalade EXT
24	Hybrid	Toyota Prius, Honda Insight

We used the Gauss Mathematical and Statistical System produced by APTECH Systems, Inc., to estimate the parameters of the nested logit model of vehicle market shares described previously in the report. This system uses a conventional maximum-likelihood procedure to estimate the parameter values for the utility function and the associated inclusive value parameter. As indicated as previously in the text, the value of this parameter provides some indication of how accurately the nesting structure used in the model (the Automotive News market segmentation) reflects buyers' views of the new vehicle market.

We experimented with a large number of alternative specifications of the utility function shown in Equation (0.6) for individual vehicle models, each using different combinations of the vehicle attributes shown in the table. We selected the combination of attributes to include in the final model on the basis of the reasonableness of the signs and relative magnitudes of their estimated coefficients, the model's ability to replicate actual market shares for individual models, and the estimated value of the nesting coefficient or inclusive value parameter.⁶⁹ Table V-3 indicates the subset of attributes that were included in final model, and reports the estimated values of their coefficients.

⁶⁹ The wide variation in the orders of magnitude of the estimated coefficients for the different attributes reflects similarly wide variation in their measurement scales.

Table V-3. NML Model Attributes and Coefficients

Attribute	Measure	Best Model Specification	
		Coefficient	t-statistic
Equivalent Price	Est. sale price plus est. fuel value over 5 years	-0.0000556	-847
Performance	Ratio of horsepower to curb weight	9.605	285
Weight	Curb weight		
Seating Capacity	Number of adults seated	0.171	688
Towing Capacity	Maximum trailer weight		
Payload	Maximum cargo weight		
Luggage Space	Enclosed cargo volume		
Fuel Economy	EPA combined MPG rating		
Fuel Tank Size	Capacity in gallons		
Refueling Range	Fuel tank capacity * MPG		
Transmission Type	Automatic =1; manual = 0		
Drive Type	2—wheel drive = 0; 4-wheel drive =1	0.054	81
Continent of Origin	Asia, Europe, or North America		
Brand	Manufacturer identity		

4. Model Convergence

After the market share model has concluded, the sales volumes of different vehicle models will typically have changed relative to values used to determine compliance with CAFE standards. Because this can cause changes in CAFE levels, the revised sales volumes are used to repeat the compliance simulation, cost allocation, and market share models. This process is repeated until the model converges, as determined by the magnitude of changes in CAFE levels and market share specific to each manufacturer and regulatory class. The process, for which Figure V-7 provides an overview, terminates if such changes are all less than 1% or if the sequence has been repeated 10 times.^{70,71}

⁷⁰ This cycling currently leads to “overcompliance” in some cases, which we are attempting to minimize by developing code to selectively “remove” technologies between iterations.

⁷¹ A limit of 10 iterations is imposed to guard against indefinite repetition. The system typically converges within 5-6 iterations to changes smaller than 1%.

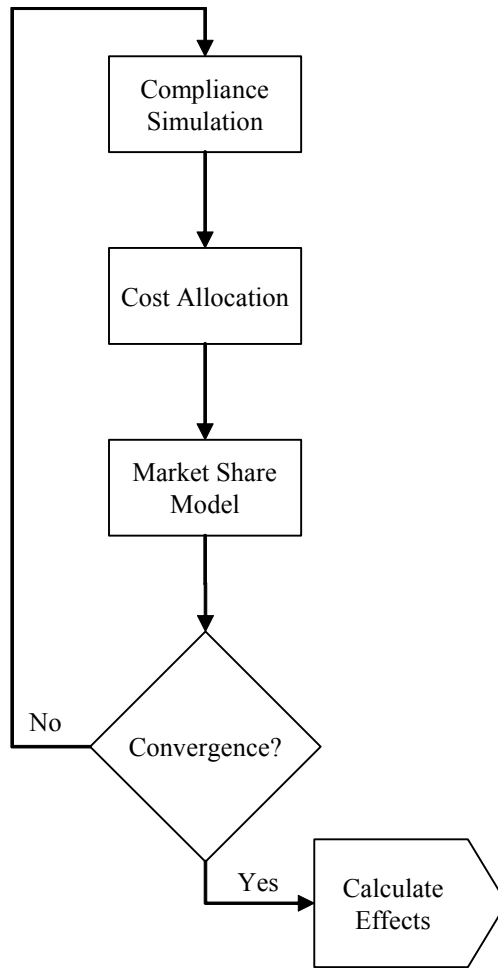

Figure V-7. Model Convergence Process

B. Technologies – Costs and Effectiveness

Technology assumptions, i.e., assumptions about their availability, cost, effectiveness, and the rate at which they can be incorporated into new vehicles, are often very controversial as they have a significant impact on the levels of the standards. Agencies must, therefore, take great care in developing and justifying these assumptions. In developing technology inputs for MY 2012-2016 standards, NHTSA and EPA reviewed, as requested by President Obama in his January 26 memorandum, the technology assumptions that NHTSA used in setting the MY 2011 standards and the comments that NHTSA received in response to its May 2008 NPRM. In addition, the agencies reviewed the technology input assumptions identified in EPA's July 2008 Advanced Notice of Proposed Rulemaking and 2008 Staff Technical Report⁷² and supplemented their review with updated information from more current literature, new product plans and from EPA certification testing

The following section details the availability, cost and effectiveness estimates completed for technologies deemed to be appropriate in the rulemaking timeframe. The estimates are drawn from an analysis conducted between NHTSA and EPA in the first half of 2009. The analysis was conducted by engineers from DOT and EPA and represents what the agencies believe to be the best available estimates for the MY 2012-2016 rulemaking timeframe.

A. NHTSA analyzes what technologies can be applied beyond those in the baseline vehicle fleet

One of the key statutory factors that NHTSA must consider in setting maximum feasible CAFE standards for each model year is the availability and feasibility of fuel saving technologies. The baseline vehicle fleet identifies the technologies already deployed for each vehicle model. The agency uses the baseline vehicle fleet data to ascertain the "baseline" capabilities and average fuel economy of each manufacturer. Given the agency's need to consider economic practicability in determining how quickly additional fuel saving technologies can be added to the baseline fleet, NHTSA researches and develops, based on the best available information and data, a list of technologies that the agencies believe will be ready for implementation during the model years covered by the rulemaking. This includes developing estimates of the costs and effectiveness of each technology and lead time needs. The resultant technology assumptions form an input into the Volpe model. The model simulates how manufacturers can comply with a given CAFE level by adding technologies beyond those included in the baseline vehicle fleet in a systematic, efficient and reproducible manner. The following sections describe NHTSA's fuel-saving technology assumptions and methodology for estimating them, and their applicability to MY 2012-2016 vehicles.

B How NHTSA decides which technologies to include

1. How NHTSA did this historically, and how for the MY 2011 Final Rule

In two of the agency's past CAFE rulemakings, which established light truck CAFE standards for MYs 2005-2007 and MYs 2008-2011, NHTSA relied on the 2002

⁷² EPA Staff Technical Report: Cost and Effectiveness Estimates of Technologies Used to Reduce Light-Duty Vehicle Carbon Dioxide Emissions. EPA420-R-08-008, March 2008.

National Academy of Sciences' report, "Effectiveness and Impact of Corporate Average Fuel Economy Standards"⁷³ ("the 2002 NAS Report") for estimating potential fuel economy effectiveness values and associated retail costs of applying combinations of technologies in 10 classes of production vehicles. The NAS study was commissioned by the agency, at the direction of Congress, in order to provide independent and peer reviewed estimates of cost and effectiveness numbers. The NAS list was determined by a panel of experts formed by the National Academy of Sciences, and was then peer-reviewed by individuals chosen for their diverse perspectives and technical expertise in accordance with procedures approved by the Report Review Committee of the National Research.

In the 2008 NPRM, NHTSA explained that there has been substantial advancement in fuel-saving automotive technologies since the publication of the 2002 NAS Report. New technologies, *i.e.*, ones that were not assessed in the NAS report, have appeared in the market place or are expected to appear in the timeframe of the proposed rulemaking. Also, new studies have been conducted and reports issued by several other organizations providing new or different information regarding the fuel economy technologies that will be available and their costs and effectiveness values. To aid the agency in assessing these developments, NHTSA contracted with the NAS to update the fuel economy section, Chapter 3, of the 2002 NAS Report. However, as NHTSA explained, the NAS update was not available in time for this rulemaking.

Accordingly, NHTSA worked with EPA staff to update the technology assumptions, and used the results as a basis for its NPRM. EPA staff published a related report and submitted it to the NAS committee.⁷⁴

For the MY 2011 final rule, NHTSA hired an international consulting firm, Ricardo, to aid the agency in analyzing the comments the agency received in response to its 2008 NPRM. Ricardo's role was as a technical advisor to NHTSA staff. In this capacity, Ricardo helped NHTSA undertake a comprehensive review of the NPRM technology assumptions and all comments received on those assumptions, based on both old and new public and confidential manufacturer information. Relying on the technical expertise of Ricardo and taking into consideration all the information available, NHTSA revised its estimates of the availability and applicability of many technologies. While NHTSA sought Ricardo's expertise and relied significantly on their assistance as a neutral expert in developing its technical assumptions, it retained responsibility for the final assumptions. The agency believed that the assumptions of availability and applicability for the MY 2011 final rule were more accurate than those used in the NPRM, and were the best available for purposes of that rulemaking.

- C. What technology assumptions has NHTSA used for the final rule?**
- 1. How do NHTSA's technology assumptions in the NPRM differ from those used in the MY 2011 final rule?**

⁷³ National Research Council, "Effectiveness and Impact of Corporate Average Fuel Economy (CAFE) Standards," National Academy Press, Washington, DC (2002). Available at <http://www.nap.edu/openbook.php?isbn=0309076013> (last accessed October 11, 2008).

⁷⁴ EPA Staff Technical Report: Cost and Effectiveness Estimates of Technologies Used to Reduce Light-Duty Vehicle Carbon Dioxide Emissions, EPA 420-R-08-008, March 2008.

In developing this proposal, and in working in conjunction with the EPA, NHTSA has revised certain aspects of the Volpe modeling process such as the inputs, data, modeling techniques, and the constraints it uses in assessing appropriate stringency for future CAFE standards. The following section discusses several of the more important changes and revisions, and also advises where more information can be found on these and other changes.

Baseline and Market Data File:

One of the primary inputs to the Volpe model is the market data file that contains detailed information about the baseline vehicle fleet, the starting point from which technological changes will be modeled, and the future vehicle fleet that is envisioned to be sold throughout the rulemaking period, MY 2012 to 2016 in this case. NHTSA has historically based its analysis of potential new CAFE standards on detailed product plans the agency has requested from manufacturers planning to produce light vehicles for sale in the United States. In contrast, the current market forecast is based primarily on information sources which are all either in the public domain or available commercially, with the primary source and starting point for the fleet being MY 2008 vehicles represented in EPA certification data.

There are advantages to this approach, namely transparency, including the potential for the agency to make available the market data file used in its analysis, and the potential to reduce errors due to manufacturers' misunderstanding of NHTSA's request for information. There are also disadvantages, namely that the current market forecast does not represent certain changes likely to occur in the future vehicle fleet as opposed to the MY 2008 vehicle fleet, such as vehicles being discontinued and newly introduced. On balance, however, the agencies have carefully considered these advantages and disadvantages of using a market forecast derived from public and commercial sources rather than from manufacturers' product plans, and conclude that the advantages outweigh the disadvantages.

More information on the advantages and disadvantages of the current approach and the agencies' decision to follow it is available in Section II.B.3 of the Preamble, and Section I of the joint TSD describes in greater detail the process the agencies used in sourcing the data for the baseline fleet and developing it into a representation of a future fleet.

Revisions to Technologies and Their Estimates:

Specific to its modeling for this proposal, NHTSA has also revised eight of the technologies used in the current analysis from those considered in the MY 2011 final rule. Specifically, two technologies which were previously unavailable in the MY 2011 time frame are now available (in the extended MY 2012-2016 period); one technology has been combined with another; one is newly introduced; three have revised names and/or definitions; and one has been deleted entirely. These changes are discussed in greater detail below, in the joint TSD, and in the Preamble, including a detailed list of the specific changes made for each technology.

Building on NHTSA's estimates developed for the MY 2011 CAFE final rule and EPA's Advanced Notice of Proposed Rulemaking, which relied on the 2008 Staff

Technical Report,⁷⁵ the agencies took a fresh look at technology cost and effectiveness values for purposes of the joint proposal under the National Program. Generally speaking, while NHTSA found that much of the cost information used in the MY 2011 final rule and EPA's 2008 staff report was consistent to a great extent, the agencies, in reconsidering information from many sources, revised the component costs of several major technologies including: turbocharging/downsizing, mild and strong hybrids, diesels, SGDI, and Valve Train Lift Technologies. These are discussed at length in the joint TSD and in this document below. Additionally, most of the effectiveness estimates used in the both the MY 2011 final rule and the 2008 EPA staff report were determined to be accurate and were carried forward without significant change into this rulemaking. NHTSA and EPA are confident that the thorough review which has been conducted has led to the best available conclusion regarding technology costs and effectiveness estimates for the current rulemaking and resulted in excellent consistency between the agencies' respective analyses for developing the CAFE and CO₂ standards.

Changes in the Volpe Modeling Methodology:

The Volpe model was revised to add one significant new capability in terms of the way it manages technology application: the ability to simulate manufacturers' ability to engage in "multi-year planning." Multi-year planning refers to the fact that when redesigning or freshening vehicles, manufacturers can anticipate future fuel economy or CO₂ standards, and add technologies accounting for these standards. For example, a manufacturer might choose to over-comply in a given model year when many vehicle models are scheduled for redesign, in order to facilitate compliance in a later model year when standards will be more stringent yet few vehicle models are scheduled for redesign.⁷⁶ Prior comments have indicated that the Volpe model, by not representing such manufacturer choices, tended to overestimate compliance costs. However, because of the technical complexity involved in representing these choices when, as in the Volpe model, each model year is accounted for separately and explicitly, the model could not be modified to add this capability prior to the statutory deadline for the MY 2011 final standards.

The model now includes this capability, and NHTSA has applied it in analyzing the standards proposed today. NHTSA believes this better represents how manufacturers would actually respond to new CAFE standards, and thereby produces more realistic estimates of the costs and benefits of such standards. Other changes made to the modeling process are discussed further in the Preamble.

Revisions to the Refresh/Redesign Cycle Times and How the Schedules Are Established:

Manufacturers typically plan vehicle changes to coincide with certain stages of a vehicle's life cycle that are appropriate for the change, or in this case the technology being applied. In the automobile industry there are two terms that describe *when* technology changes to vehicles occur: redesign and refresh (*i.e.*, freshening). Vehicle

⁷⁵ EPA Staff Technical Report: Cost and Effectiveness Estimates of Technologies Used to Reduce Light-Duty Vehicle Carbon Dioxide Emissions. EPA420-R-08-008, March 2008.

⁷⁶ Although a manufacturer may, in addition, generate CAFE credits in early model years for use in later model years (or, less likely, in later years for use in early years), EPCA does not allow NHTSA, when setting CAFE standards, to account for manufacturers' use of CAFE credits.

redesign usually refers to significant changes to a vehicle's appearance, shape, dimensions, and powertrain, while vehicle *refresh* usually refers to less extensive vehicle modifications, such as minor changes to a vehicle's appearance, a moderate upgrade to a powertrain system, or small changes to the vehicle's feature or safety equipment content. NHTSA stipulates, and thereby constrains whether a particular technology can be applied any time, at refresh/redesign, or only at redesign cycle, and for the majority of technologies considered in this analysis, the Volpe model will only be allowed to apply them at a refresh or redesign cycles, since in most cases their application would be significant enough to involve some level of engineering, testing, and calibration work.⁷⁷ The cycle settings used in the current proposal are shown below in Table V-4 and are virtually identical to those use in the MY 2011 final rule.

Table V-4. Technology Refresh and Redesign Application

Technology	Redesign only	Redesign or Refresh	Anytime
Low Friction Lubricants			X
Engine Friction Reduction		X	
VVT - Coupled Cam Phasing (CCP) on SOHC		X	
Discrete Variable Valve Lift (DVVL) on SOHC	X		
Cylinder Deactivation on SOHC		X	
VVT - Intake Cam Phasing (ICP)		X	
VVT – Dual Cam Phasing (DCP)		X	
Discrete Variable Valve Lift (DVVL) on DOHC	X		
Continuously Variable Valve Lift (CVVL)	X		
Cylinder Deactivation on DOHC		X	
Cylinder Deactivation on OHV		X	
VVT - Coupled Cam Phasing (CCP) on OHV		X	
Discrete Variable Valve Lift (DVVL) on OHV	X		
Conversion to DOHC with DCP	X		
Stoichiometric Gasoline Direct Injection (GDI)	X		
Combustion Restart		X	
Turbocharging and Downsizing	X		
Exhaust Gas Recirculation (EGR) Boost	X		
Conversion to Diesel following CBRST	X		
Conversion to Diesel following TRBDS	X		
6-Speed Manual/Improved Internals	X		
Improved Auto. Trans. Controls/Externals		X	
Continuously Variable Transmission	X		
6/7/8-Speed Auto. Trans with Improved Internals	X		
Dual Clutch or Automated Manual Transmission	X		
Electric Power Steering		X	

⁷⁷ For example, applying material substitution through weight reduction, or even something as simple as low rolling-resistance tires, to a vehicle will likely require some level of validation and testing to ensure that the vehicle may continue to be certified as compliant with NHTSA's Federal Motor Vehicle Safety Standards (FMVSS). Weight reduction might affect a vehicle's crashworthiness; low rolling-resistance tires might change vehicle's braking characteristics or how it performs in crash avoidance tests.

Improved Accessories		X	
12V Micro-Hybrid	X		
Belt Integrated Starter Generator	X		
Crank Integrated Starter Generator	X		
Power Split Hybrid	X		
2-Mode Hybrid	X		
Plug-in Hybrid	X		
Mass Reduction 1 (1.5%)		X	
Mass Reduction 2 (3.5% – 8.5%)	X		
Low Rolling Resistance Tires		X	
Low Drag Brakes		X	
Secondary Axle Disconnect 4WD		X	
Aero Drag Reduction		X	

The refresh/redesign/anytime data forms another input to the Volpe model and therefore NHTSA must develop redesign and refresh schedules (i.e., MYs where these cycles will occur) for each of a manufacturer's vehicles included in the analysis. We note that the approach used in this analysis is different than NHTSA has employed previously for determining these schedules, since previously NHTSA included the redesign and refresh dates provided by manufacturers in their confidential product plans. The new approach is necessary given the nature of the new baseline fleet which as a single year of data does not contain its own refresh and redesign cycle cues for future model years. Vehicle redesign/refresh assumptions, and the method NHTSA used for establishing them, are discussed in greater detail in the TSD; however a brief description of the process follows.

Consistent with its forecast of the overall size of the light vehicle market from MY 2011 on, the agency tentatively expects that the industry's status will improve and that manufacturers will typically redesign both car and truck models every 5 years in order to be competitive in the market. Thus, the agency is retaining the 5-year redesign with 2-3 year refresh cycle assumptions for the current proposal, noting that, for the most part, the cycle times are supported by manufacturer's confidential responses to NHTSA's March 2009 product plan request.

NHTSA determined redesign schedules for the baseline MY 2008 vehicles, using publicly-available data and its own engineering judgment, which required finding the date of most recent redesign for each vehicle. Next, the agency applied 5-year redesign cycles to obtain new redesign dates for each vehicle, starting with the date of most recent redesign and working forward. Thus, a vehicle that was determined to have been last redesigned in MY 2008 would be projected to be redesigned again in MY 2013. NHTSA ensured that most if not all vehicles had a redesign scheduled within the rulemaking time frame, which is consistent with the industry's confidential product plan responses, and since most manufacturers appear to be redesigning the vast majority of today's vehicles, or replacing them with new models, between now and the end of MY 2016. Finally, the agency determined refresh dates in a similar fashion, based on the established redesign cycles of the baseline fleet and using 2 to 3 year refresh cycle timing, also working to ensure that all vehicles underwent one refresh cycle within the rulemaking time frame. Additional information regarding the Volpe models use of cycle timing and the revisions

and modifications made for this proposal can be found in the joint TSD and in the Preamble.

Revisions to the Phase-in Caps Used in the Volpe Modeling Process:

Besides the refresh/redesign cycles used in the Volpe model, which constrain the rate of technology application at the vehicle level so as to ensure a period of stability following any modeled technology applications, the other constraint on technology application employed in NHTSA's analysis is "phase-in caps." Unlike vehicle-level cycle settings, phase-in caps constrain technology application at the vehicle manufacturer level.⁷⁸ They are intended to reflect a manufacturer's overall resource capacity available for implementing new technologies (such as engineering and development personnel and financial resources), thereby ensuring that resource capacity is accounted for in the modeling process. At a high level, phase-in caps and refresh/redesign cycles work in conjunction with one another to avoid the modeling process out-pacing an OEM's limited pool of available resources during the rulemaking time frame, especially in years where many models may be scheduled for refresh or redesign. This helps to ensure technological feasibility and economic practicability in determining the stringency of the standards.

NHTSA discusses the concept, development and use of phase-in caps in greater detail in the MY 2011 final rule,⁷⁹ and in the joint TSD and in the preamble. In the final rule, NHTSA emphasized that the MY 2011 phase-in caps were based on assumptions for the full five year period of the 2008 proposal (2011-2015), and stated that it would reconsider the phase-in settings for all years beyond 2011 in any future rulemaking analysis, which NHTSA has done in the development of phase-in caps for this proposal.

For purposes of the current proposal for MYs 2012-2016, Table V-5 below outlines the phase-in caps for the technologies used on a by-model-year basis. As in the MY 2011 final rule, NHTSA combines phase-in caps for some groups of similar technologies, such as valve phasing technologies that are applicable to different forms of engine design (SOHC, DOHC, OHV), since they are very similar from an engineering and implementation standpoint. When the phase-in caps for two technologies are combined, the maximum total application of either or both to any manufacturers' vehicle fleet is limited to the value of the cap.⁸⁰ In contrast to the phase-in caps used in the MY 2011 final rule, NHTSA has increased the phase-in caps for most of the technologies, except those for diesels and stronger hybrid technologies, as discussed below.

In developing phase-in cap values for purposes of the current proposal, NHTSA initially considered the fact that many of the technologies commonly applied by the model, those placed near the top of the decision trees, such as low friction lubes, valve

⁷⁸ While phase-in caps are expressed as specific percentages of a manufacturer's fleet to which a technology may be applied in a given model year, phase-in caps cannot always be applied as precise limits, and the Volpe model in fact allows "override" of a cap in certain circumstances. When only a small portion of a phase-in cap limit remains, or when the cap is set to a very low value, or when a manufacturer has a very limited product line, the cap might prevent the technology from being applied at all since any application would cause the cap to be exceeded. Therefore, the Volpe model evaluates and enforces each phase-in cap constraint after it has been exceeded by the application of the technology (as opposed to evaluating it before application), which can result in the described overriding of the cap.

⁷⁹ 74 FR 14268-14271 (Mar. 30, 2009)

⁸⁰ See 74 FR 14270 (Mar 30, 2009) for further discussion and examples.

phasing, electric power steering, improved automatic transmission controls, and others, have been commonly available to manufacturers for several years now. Many technologies, in fact, precede the 2002 NAS Report, which estimated that such technologies would take 4 to 8 years to penetrate the fleet. Since the current proposal would take effect in MY 2012, nearly 10 years beyond the NAS report, and extends to MY 2016, NHTSA determined that higher phase-in caps were likely justified. Additionally, NHTSA considered the fact that manufacturers, as part of the agreements supporting the National Program, appear to be anticipating higher technology application rates than those used in the MY 2011 final rule. This also supported higher phase-in caps of commonly applied technologies for purposes of the proposal.

However, for a few of the more complex and intrusive (from an implementation perspective) technologies, specifically dieselization and stronger hybridization, NHTSA has retained the more stringent phase-in levels used in the 2011 final rule since these technologies represent, for the most part, a significant departure from the vehicle architectures commonly utilized by most OEMs today. As was the case in the 2011 rule, these more stringent phase-in caps limit technology application, i.e., due to the Volpe modeling process, to 3 percent per annum up to a maximum of 15 percent by the 2016 model year.⁸¹ Additionally, for some technologies that are not available in certain model years, a phase-in cap of 0 percent is shown for those model years, such as one of the mass reduction technologies that is not determined to be available until 2014; hence the values of 0 percent for MYs 2012 and 2013 shown in Table V-5 below.

Theoretically, significantly higher phase-in caps, such as those used in the current proposal as compared to those used in the MY 2011 final rule, should result in higher levels of technology penetration in the modeling results. Reviewing the modeling output does not, however, indicate unreasonable levels of technology penetration as shown in Tables V-45 and V-46. NHTSA believes that this is due to the interaction of the various changes in methodology for the current proposal--changes to phase-in caps are but one of a number of revisions to the Volpe model and its inputs that could potentially impact the rate at which technologies are applied in this proposal as compared to prior rulemakings. Other revisions that could impact application rates include the use of transparent CAFE certification data in baseline fleet formulation and the use of other data for projecting it forward,⁸² or the use of a multi-year planning programming technique to apply technology retroactively to earlier-MY vehicles, both of which may have a direct impact on the modeling process. Conversely the model and inputs remain unchanged in other areas that also could impact technology application, such as in the refresh/redesign cycle settings, or the effectiveness estimates used for the technologies, both of which remain largely unchanged from the MY 2011 final rule. These changes together make it difficult to predict how phase-in caps should be expected to function in the new modeling process.

Thus, after reviewing the output files, NHTSA believes that the higher phase-in caps, and the resulting technology application rates produced by the Volpe model, at both

⁸¹ A 15 percent maximum application rate should not be confused with the overall penetration of the technology, i.e., the amount of the technology applied by the modeling process plus that which existed in the baseline or was installed at the discretion of the manufacturer. Penetration rates typically exceed application rates.

⁸² The baseline fleet sets the starting point, from a technology point of view, for where the model begins the technology application process, so changes have a direct impact on the net application of technology.

the industry and manufacturer level, are appropriate for this proposal, achieving a suitable level of stringency without requiring unrealistic or unachievable penetration rates.

Table V-5 Phase in Caps for the Current Proposal

<i>Technology</i>	<i>Phase-In Caps by Model Year *</i>				
	2012	2013	2014	2015	2016
Low Friction Lubricants	100%	100%	100%	100%	100%
Engine Friction Reduction	85%	85%	85%	100%	100%
VVT - Coupled Cam Phasing (CCP) on SOHC	85%	85%	85%	100%	100%
Discrete Variable Valve Lift (DVVL) on SOHC	85%	85%	85%	100%	100%
Cylinder Deactivation on SOHC	85%	85%	85%	85%	85%
VVT - Intake Cam Phasing (ICP)	85%	85%	85%	100%	100%
VVT – Dual Cam Phasing (DCP)	85%	85%	85%	100%	100%
Discrete Variable Valve Lift (DVVL) on DOHC	85%	85%	85%	100%	100%
Continuously Variable Valve Lift (CVVL)	85%	85%	85%	100%	100%
Cylinder Deactivation on DOHC	85%	85%	85%	85%	85%
Cylinder Deactivation on OHV	85%	85%	85%	85%	85%
VVT - Coupled Cam Phasing (CCP) on OHV	85%	85%	85%	100%	100%
Discrete Variable Valve Lift (DVVL) on OHV	85%	85%	85%	100%	100%
Conversion to DOHC with DCP	85%	85%	85%	85%	85%
Stoichiometric Gasoline Direct Injection (GDI)	85%	85%	85%	85%	85%
Combustion Restart	0%	0%	85%	85%	85%
Turbocharging and Downsizing	85%	85%	85%	85%	85%
Exhaust Gas Recirculation (EGR) Boost	0%	85%	85%	85%	85%
Conversion to Diesel following CBRST	3%	6%	9%	12%	15%
Conversion to Diesel following TRBDS	3%	6%	9%	12%	15%
6-Speed Manual/Improved Internals	85%	85%	85%	100%	100%
Improved Auto. Trans. Controls/Externals	85%	85%	85%	100%	100%
Continuously Variable Transmission	85%	85%	85%	85%	85%
6/7/8-Speed Auto. Trans with Improved Internals	85%	100%	100%	100%	100%
Dual Clutch or Automated Manual Transmission	85%	100%	100%	100%	100%
Electric Power Steering	85%	85%	85%	100%	100%
Improved Accessories	85%	85%	85%	100%	100%
12V Micro-Hybrid	85%	85%	85%	85%	85%
Belt mounted Integrated Starter Generator	85%	85%	85%	85%	85%
Crank mounted Integrated Starter Generator	3%	6%	9%	12%	15%
Power Split Hybrid	3%	6%	9%	12%	15%
2-Mode Hybrid	3%	6%	9%	12%	15%
Plug-in Hybrid	3%	6%	9%	12%	15%
Mass Reduction (1.50%)	85%	85%	85%	85%	100%
Mass Reduction (5% to 10% Cum)	85%	85%	85%	85%	100%
Low Rolling Resistance Tires	85%	85%	85%	100%	100%
Low Drag Brakes	85%	85%	85%	100%	100%
Secondary Axle Disconnect - Ladder Frame	85%	85%	85%	100%	100%
Aero Drag Reduction	85%	85%	85%	100%	100%

* - a phase-in cap of 0% is shown for the years the technology is unavailable

2. How are technologies applied in the model?

As in the MY 2011 final rule, each technology is assigned to one of the five following categories based on the system it affects or impacts: engine, transmission, electrification/accessory, hybrid or vehicle. Each of these categories has its own decision tree that the CAFE model uses to apply technologies sequentially during the compliance analysis. The decision trees were designed and configured to allow the CAFE model to apply technologies in a cost-effective, logical order that also considers ease of implementation. For example, software or control logic changes are implemented before replacing a component or system with a completely redesigned one, which is typically a much more expensive option. In some cases, and as appropriate, the model may combine the sequential technologies shown on a decision tree and apply them simultaneously, effectively developing dynamic technology packages on an as-needed basis. For example, if compliance demands indicate, the model may elect to apply LUB, EFR, and ICP on a dual overhead cam engine, if they are not already present, in one single step.

Each technology within the decision trees has an incremental cost and an incremental effectiveness estimate associated with it, and estimates are specific to a particular vehicle subclass. Each technology's incremental estimate takes into account its position in the decision tree path. If a technology is located further down the decision tree, the estimates for the costs and effectiveness values attributed to that technology are influenced by the incremental estimates of costs and effectiveness values for prior technology applications. In essence, this approach accounts for "in-path" effectiveness synergies, as well as cost effects that occur between the technologies in the same path. When comparing cost and effectiveness estimates from various sources and those provided by commenters in the previous CAFE rulemakings, it is important that the estimates evaluated are analyzed in the proper context, especially as concerns their likely position in the decision trees and other technologies that may be present or missing. Not all estimates available in the public domain or offered for the agencies' consideration during the comment period can be evaluated in an "apples-to-apples" comparison with those used by the CAFE model, since in some cases the order of application, or included technology content, is inconsistent with that assumed in the decision tree.

In the MY 2011 final rule, significant revisions had been made to the sequence of technology applications within the decision trees, and in some cases the paths themselves had been modified and additional paths had been added. These revisions were maintained for this NPRM analysis. The additional paths allow for a more accurate application of technology, insofar as the model now considers the existing configuration of the vehicle when applying technology. In this analysis, single overhead camshaft (SOHC), dual overhead camshaft (DOHC) and overhead valve (OHV) configured engines now have separate paths that allow for unique path-dependent versions of certain engine technologies. Thus, the cylinder deactivation technology (DEAC) now consists of three unique versions that depend on whether the engine being evaluated is an SOHC, DOHC or OHV design; these technologies are designated by the abbreviations DEACS, DEACD and DEACO, respectively, to designate which engine path they are located on. Similarly the last letter for the Coupled Cam Phasing (CCP) and Discrete Variable Valve Lift (DVVL) abbreviations are used to identify which path the technology is applicable to.

Use of separate valvetrain paths and unique path-dependent technology variations also ensures that the incremental cost and effectiveness estimates properly account for technology effects so as not to “double-count.” For example, in the SOHC path, the incremental effectiveness estimate for DVVLS assumes that some pumping loss reductions have already been accomplished by the preceding technology, CCPS, which reduces or diminishes the effectiveness estimate for DVVLS because part of the efficiency gain associated with the reduction of the pumping loss mechanism has already occurred. This accounting approach resolves this potential double-counting issue.

To address any potential confusion, NHTSA would like to draw attention to the retention of previously applied technologies when more advanced technologies (*i.e.*, those further down the decision tree) were applied. In both the MY 2011 final rule and this NPRM, as appropriate and feasible, previously-applied technologies are retained in combination with the new technology being applied, but this is not always the case. For instance, one exception to this would be the application of diesel technology, where the entire engine is assumed to be replaced, so gasoline engine technologies cannot carry over. This exception for diesels, along with a few other technologies, is documented below in the detailed discussion of each decision tree and corresponding technologies.

As the Volpe model steps through the decision trees and applies technologies, it accumulates total or “NET” cost and effectiveness values. Net costs are accumulated using an additive approach while net effectiveness estimates are accumulated multiplicatively. As with the MY 2011 final rule, the decision trees have been expanded so that NHTSA is better able to track the incremental and net/cumulative cost and effectiveness of each technology, which substantially improves the “accounting” of costs and effectiveness for the NPRM.⁸³ To help readers better understand the accumulation process, and in response to comments expressing confusion on this subject, the following examples demonstrate how the Volpe model calculates net values.

Accumulation of net cost is explained first as this is the simpler process. This example uses the Electrification/Accessory decision tree sequentially applying the EPS, IACC, MHEV, BISG and CISG technologies to a subcompact vehicle using the cost and effectiveness estimates from its input sheet. As seen in Table V-6 below, the input sheet cost estimates have a lower and upper value which may be the same or a different value (*i.e.*, a single value or a range) as shown in columns two and three. The Volpe model first averages the values (column 4), and then sums the average values to calculate the net cost of applying each technology (column 5). Accordingly, the net cost to apply the

⁸³ In addition to the (simplified) decision trees, as published in this document, NHTSA also utilized “expanded” decision trees in the NPRM analysis. Expanded decision trees graphically represent each unique path, considering the branch points available to the Volpe model, which can be utilized for applying fuel saving technologies. For instance, the engine decision tree shown in this document has 20 boxes representing engine technologies, whereas the expanded engine decision tree requires a total of 45 boxes to accurately represent all available application variants. Expanded decision trees presented a significant improvement in the overall assessment and tracking of applied technologies since they allowed NHTSA staff to accurately view and assess both the incremental and the accumulated, or net cost and effectiveness at any stage of technology application in a decision tree. Because of the large format of the expanded decision trees, they could not be included in the Federal Register, so NHTSA refers the reader to Docket No. NHTSA-2009-0059. Expanded decision trees for the engine, electrification/transmission/hybridization, and the vehicle technologies (three separate decision trees) were developed for each of the 12 vehicle technology application classes and have been placed in the docket for the reader’s information.

MHEV technology for example would be (\$106.00+ \$128.00 + \$288.00 = \$522.00). Net costs are calculated in a similar manner for all the decision trees.

Table V-6 Sample Volpe Model Net Cost Calculation

Example Net Cost Calculation: Elect./Acc. Path, Subcompact Vehicle Subclass				
Tech. Abrev.	Lower INCR Cost	Upper INCR Cost	Avg. INCR Cost	NET Cost
EPS	\$ 106.00	\$ 106.00	\$ 106.00	\$ 106.00
IACC	\$ 128.00	\$ 128.00	\$ 128.00	\$ 234.00
MHEV	\$ 288.00	\$ 288.00	\$ 288.00	\$ 522.00
BISG	\$ 286.00	\$ 286.00	\$ 286.00	\$ 808.00
CISG	\$ 2,791.00	\$ 2,791.00	\$ 2,791.00	\$ 3,599.00

The same decision tree, technologies, and vehicle are used for the example demonstrating the model's net effectiveness calculation. Table V-7 below shows average incremental effectiveness estimates in column two; this value is calculated in the same manner as the cost estimates above (average of lower and upper value taken from the input sheet). To calculate the change in fuel consumption due to application of the EPS technology with incremental effectiveness of 1.5 percent (or 0.015 in decimal form, column 3), when applied multiplicatively, means that the vehicle's current fuel consumption 'X' would be reduced by a factor of $(1 - 0.015) = 0.985$,⁸⁴ or mathematically $0.985 * X$. To represent the changed fuel consumption in the normal fashion (as a percentage change), this value is subtracted from 1 (or 100%) to show the net effectiveness in column 5.

As the IACC technology is applied, the vehicle's fuel consumption is already reduced to 0.985 of its original value. Therefore the reduction for an additional incremental 1.5 percent results in a new fuel consumption value of 0.9702, or a net 2.98 percent effectiveness, as shown in the table. Net effectiveness is calculated in a similar manner for the all decision trees. It should be noted that all incremental effectiveness estimates were derived with this multiplicative approach in mind; calculating the net effectiveness using an additive approach will yield a different and incorrect net effectiveness.

Table V-7 Sample Volpe Model Net Effectiveness Calculation

⁸⁴ A decrease in fuel consumption (FC) means the fuel economy (FE) will be increased since fuel consumption and economy are related by the equation $FC = 1/FE$.

Example Net Effectiveness Calculation: Elect./Acc. Path, Subcompact Vehicle Subclass				
Tech. Abrev.	Avg. INCR Eff. %	Avg. INCR Eff. (decimal)	Multiplicative FC Reduction Current FC * (1-Avg INCR)	Net Effect. (1 - Red)
EPS	1.50%	0.0150	$1 * (1 - 0.015) = 0.985$	1.50%
IACC	1.50%	0.0150	$0.985 * (1 - 0.015) = 0.9702$	2.98%
MHEV	2.50%	0.0250	$0.9702 * (1 - 0.0250) = 0.9459$	5.41%
BISG	5.00%	0.0500	$0.99459 * (1 - 0.0500) = 0.8986$	10.14%
CISG	8.75%	0.0875	$0.8986 * (1 - 0.0875) = 0.8200$	18.00%

To improve the accuracy of accumulating net cost and effectiveness estimates, “path-dependent corrections” were employed in the MY 2011 final rule and are being utilized in this NPRM. The prior NPRM analysis (2008) had the potential to either overestimate or underestimate net cost and effectiveness depending on which decision tree path the Volpe model followed when applying the technologies. For example, if in the 2008 NPRM analysis a diesel technology was applied to a vehicle that followed the OHV path, the net cost and effectiveness could be different from the net estimates for a vehicle that followed the OHC path even though the intention was to have the same net cost and effectiveness. In order to correct this issue path-dependent correction tables were added to the input sheets. The model uses these tables to correct net cost and effectiveness estimate differences that occur when multiple paths lead into a single technology that is intended to have the same net cost and effectiveness no matter which path was followed.⁸⁵ Path-dependent corrections were used when applying cylinder deactivation (on the DOHC path), turbocharging and downsizing, diesel and strong hybrids. For the engine technologies listed in the preceding sentence, the fuel consumption and cost estimates stated in following sections and the input sheets are for an SOHC engine. The correction tables discussed above are then used to adjust the estimates for the different paths (i.e. DOHC or OHV). Similarly, all strong hybrid fuel consumption and cost estimates stated in the following section and the input sheets are relative to a vehicle that is following the CVT path, discussed in the Electrification/Accessory Technology Decision Tree section below. For a vehicle that is following the 6-, 7- and 8-speed automatic transmission path into the strong hybrids the correction tables are used to adjust the estimates from the CVT path.

3. Technology application decision trees

The following paragraphs explain, in greater detail, the decision tree logic and revisions to the decision trees from the MY 2011 final rule.

Engine Technology Decision Tree

⁸⁵ The correction tables are used for path deviations within the same decision tree. However, there is one exception to this rule, specifically that the tables are used to keep the model from double-counting cost and effectiveness estimates when both the CBRST and MHEV are applied to the same vehicle. Both technologies try to accomplish the same goal of reducing fuel consumption, by limiting idle time, but through different means. If either of these technologies exists on a vehicle and the Volpe model applies the other, the correction tables are used to remove the cost and effectiveness estimates for CBRST, thus ensuring that double-counting does not occur.

For this NPRM, NHTSA reviewed the engine decision tree and the model's technology application logic used in the MY 2011 final rule, and concluded that no revisions were necessary to the engine tree at this time. Figure V-8 below shows the decision tree for the engine technology category.

As in the MY 2011 final rule, NHTSA does not show Camless Valve Actuation (CVA), Lean-Burn GDI (LBDI), and Homogenous Charge Compression Ignition (HCCI) on the decision trees because these technologies were determined to be in the research phase of development; no new information to suggest these technologies are under development has been received at this time. As also discussed in the MY 2011 final rule, SOHC, DOHC and OHV engines have separate paths to allow the model to apply unique path-dependent valvetrain technologies (Variable Valve Timing, Variable Valve Lift, and cylinder deactivation) that are tailored to those specific engine types. This approach also improves the accuracy of accounting for net cost and effectiveness compared to that used in the 2008 NPRM or prior rulemakings.

Also as in the MY 2011 final rule, the Turbocharging and Downsize technology (TRBDS) is considered to be a completely new engine that has been converted to DOHC (if not already a DOHC in the baseline vehicle) with LUB, EFR, DCP, SGDI and CBRST applied. Similarly, the conversion to Diesel (DSLCL and DSLT) is considered to be a completely new engine that replaces the gasoline engine (although it carries over the LUB and EFR technologies). We note that the path-dependent variations of these three technologies (TRBDS, DSLCL, and DSLT) all result in the same technology state for the modified vehicle regardless of the path the model followed to achieve it. Therefore, in conducting the analysis, the *net* cost and effectiveness estimates for the different engine paths are considered to be the same (regardless of path), and the *incremental* cost and effectiveness estimates are adjusted as appropriate to account for the path-dependent variations

FigureV-8. Engine Technology (EngMod) Decision Tree

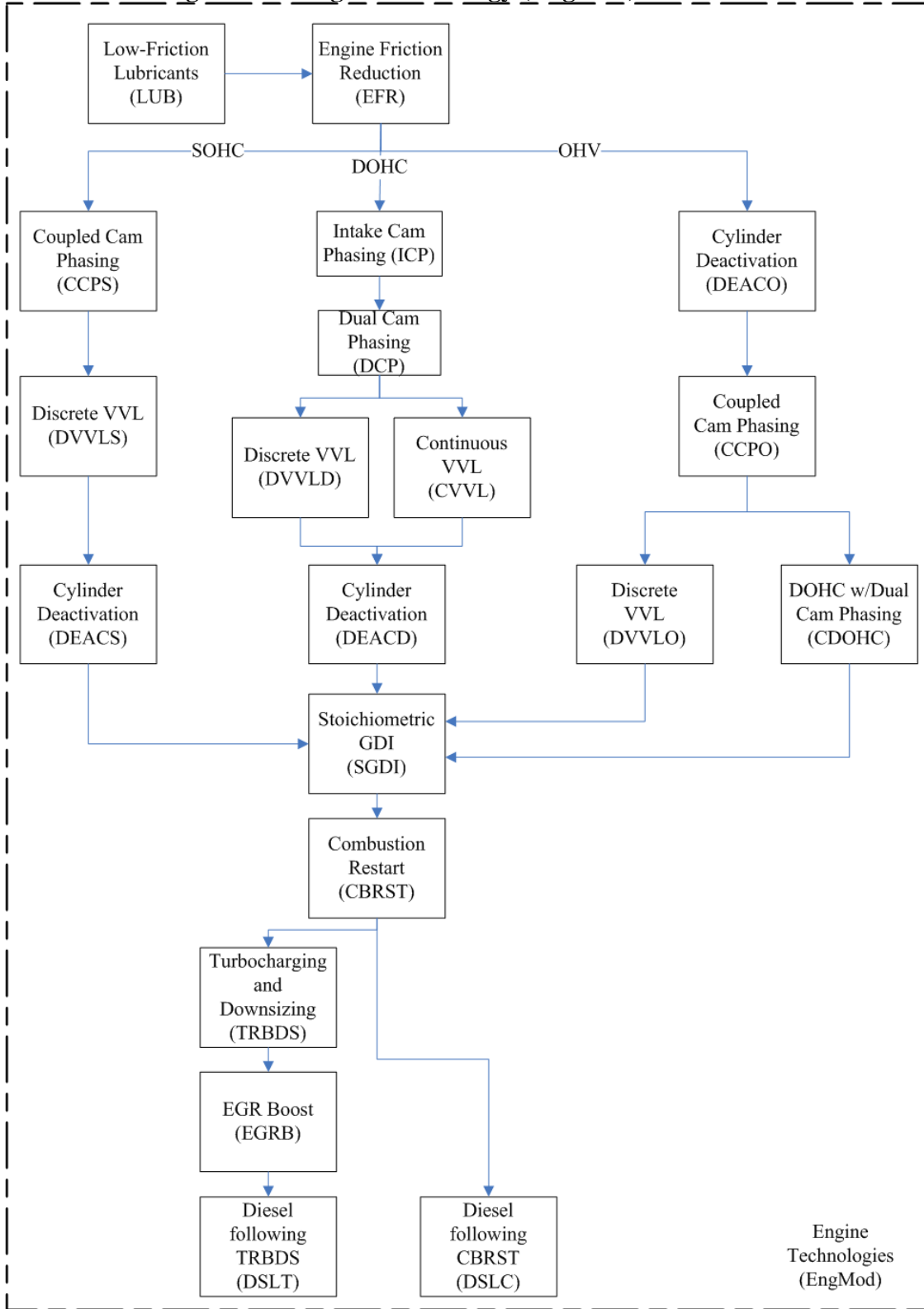

Electrification/Accessory Technology Decision Tree

After reviewing this decision tree, NHTSA made some revisions from the version used in the MY 2011 final rule. Specifically, one of the 2011 technologies (HVIA) has been incorporated into a new mild hybrid technology (BISG), which allows the model to choose from a broader range of mild hybrid options before conversion to a strong hybrid, as shown in Figure V-9. Electric Power Steering (EPS) is the first technology in this decision tree, since it is a primary enabler for both mild and strong hybrids, and is followed by Improved Accessories (IACC), as in the MY 2011 final rule. Micro-Hybrid (MHEV), a 12-volt system that offers basic idle stop/start functionality only, continues to follow as the first of the mild hybrid technologies. However, while the Higher Voltage and Improved Alternator (HVIA) technology followed MHEV in the MY 2011 final rule, for purposes of this NPRM, HVIA has been incorporated into the next technology, Belt Integrated Starter Generator (BISG). BISG represents a higher voltage, such as 42 volts, mild hybrid system with idle stop/start functionality, but with higher capability than MHEV including limited energy recovery through regenerative braking. BISG represents a mid-point option between MHEV and the next level of mild hybrid. BISG replaces the MHEV technology when it is applied, but EPS and IACC remain on the vehicle. Crank Integrated Starter Generator (CISG), the last of the mild hybrids, is also a higher voltage system with regenerative braking and limited motive power, primarily launch assist. Honda's Integrate Motor Assist (IMA) system is a good example of a commercially realized version of this technology. CISG, which is the most capable of the mild hybrid options, is the final step necessary in order to convert the vehicle to a (full) strong hybrid; it replaces BISG when it is applied, but again, the final vehicle state contains both EPS and IACC. All Electrification/Accessory technologies can be applied to both automatic and manual transmission vehicles.

Transmission Technology Decision Tree

For this NPRM, NHTSA reviewed the transmission technology decision tree and the model's technology application logic used in the MY 2011 final rule, and concluded that no revisions to the transmission tree were necessary at this time. This decision tree, shown in Figure V-9, contains two paths: one for automatic transmissions and one for manual transmissions, that are identical to those used in the MY 2011 final rule.

On the automatic path, the decision tree first optimizes the current transmission by improving the control system via the Improved Automatic Transmissions Controls and other Externals (IATC) technology before applying more expensive technologies. After IATC, the decision tree splits into a "Unibody only" and "Unibody or Ladder Frame" path, both of which result in conversion to new and fully optimized transmission designs. The Unibody only path contains the Continuously Variable Transmission (CVT) technology, while the Unibody or Ladder Frame path has 6/7/8-Speed Automatic Transmission with Improved Internals (NAUTO). The NAUTO technology is followed by Dual Clutch Transmission/Automated Manual Transmission (DCTAM) technology. Dual Clutch Transmission (DCT) designs do not suffer torque interrupt when shifting, a characteristic associated with automated manual transmission (AMT) designs. In response to comments from manufacturers expressing concern that torque interrupt will not be acceptable to consumers, the DCTAM technology is intended to use a DCT-type transmission only.

The manual transmission path again has only one technology application: conversion to a 6-Speed Manual with Improved Internals (6MAN). NHTSA anticipates limited use of manual transmissions with more than 6 speeds within the MY 2012-2016 timeframe.

Hybrid Technology Decision Tree

NHTSA also reviewed the hybrid technology decision tree and the model's technology application logic used in the MY 2011 final rule, and concluded that no revisions were necessary for the hybrid tree for this NPRM. The model continues to only apply strong hybrid technologies when both the Electrification/Accessory and Transmission (automatic transmissions only) technologies have been fully added to the vehicle, as seen in Figure V-9. When the CAFE model applies strong hybrids it takes into account that some of the fuel consumption reductions have already been included when technologies like EPS or IACC have been previously applied. When strong hybrids are required, the model chooses the most appropriate application of the Two Mode (2MHEV), Power Split (PSHEV) or Plug-in Hybrid Vehicle (PHEV), based on the vehicle's subclass and/or the most cost-effective application.

Figure V-9 Electrification/Accessory, Transmission and Hybrid Technology Decision Tree

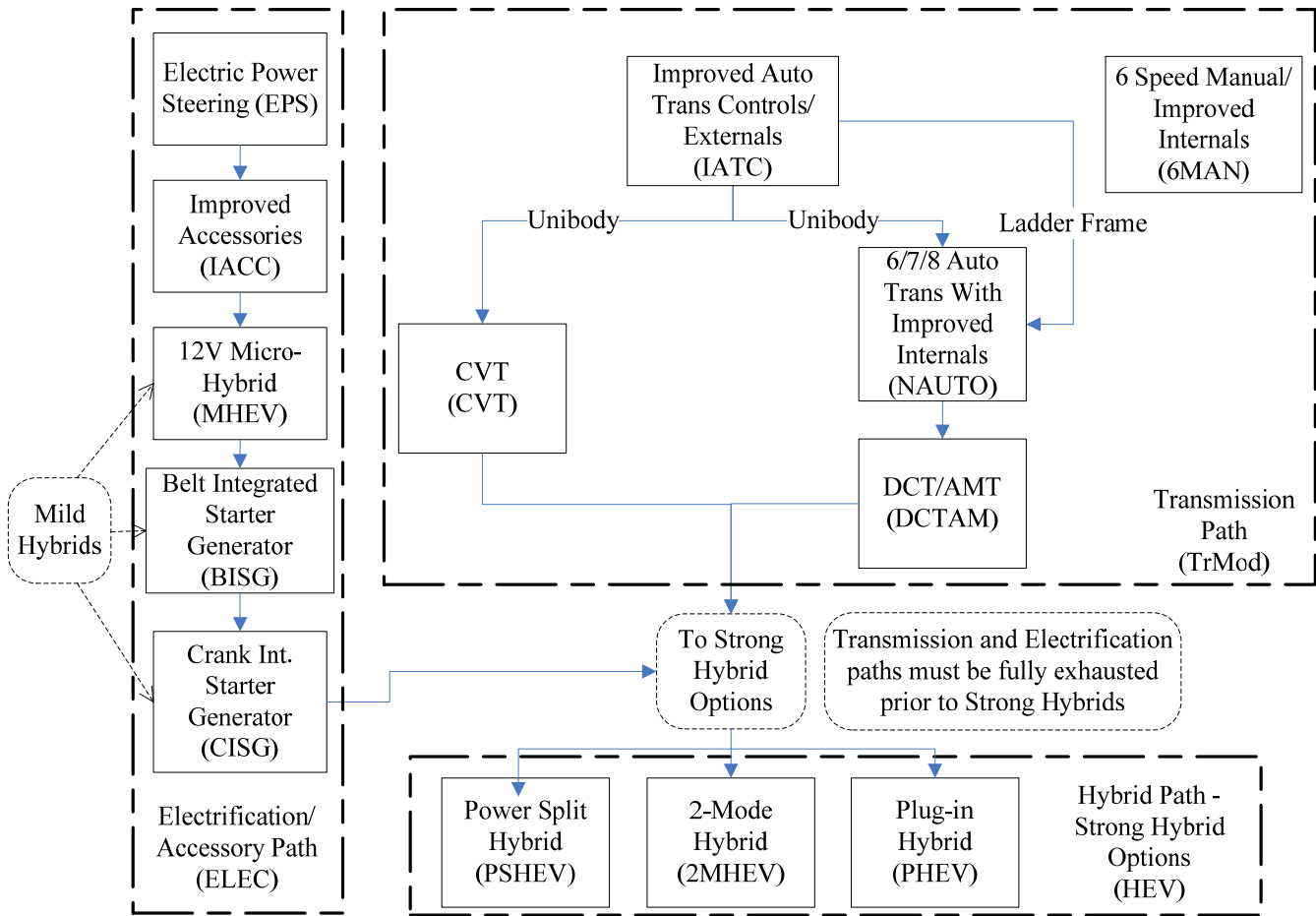

Vehicle Technology Decision Tree

After reviewing this decision tree, NHTSA made some revisions to the vehicle technology tree from the version used in the MY 2011 final rule. The MY 2011 final rule utilized three Material Substitution (MS) technologies in a dedicated path in the Vehicle Technology Decision tree. These technologies have been reconsidered for purposes of this NPRM as Mass Reduction and are discussed in greater detail below. As shown in Figure V-10, this proposal uses two technologies, (MS1) and (MS2), and a dedicated path in the Vehicle Technology Decision Tree. Both have a different definition than was used in the prior rule. The Mass Reduction 1 (MS1) technology now represents a 1.5 percent (of vehicle curb weight) weight decrease that can be applied to any subclass of vehicle at the Refresh or Redesign cycle. The MS2 technology defines a 3.5 percent to 8.5 percent subclass-dependent mass reduction, which can only be applied at the Redesign cycle, with the lower reductions occurring in the smaller/lighter vehicles. MS2 is incremental to MS1, which means that the model may, subject to subclass and cycle constraints, potentially reduce vehicle weight by a total of 5 to 10 percent (of curb weight) within the rulemaking time frame. To allow manufacturers lead time to implement larger mass reductions, the MS2 technology is made unavailable until MY 2014. Low Rolling

Resistance Tires (ROLL), Low Drag Brakes (LDB) and Secondary Axle Disconnect (SAX) all have the same definition and path as used in the MY 2011 final rule, with SAX applied to 4WD vehicles only. Aerodynamic Drag Reduction (AERO) remains a separate path.

Figure V-10 Vehicle Technology Decision Tree

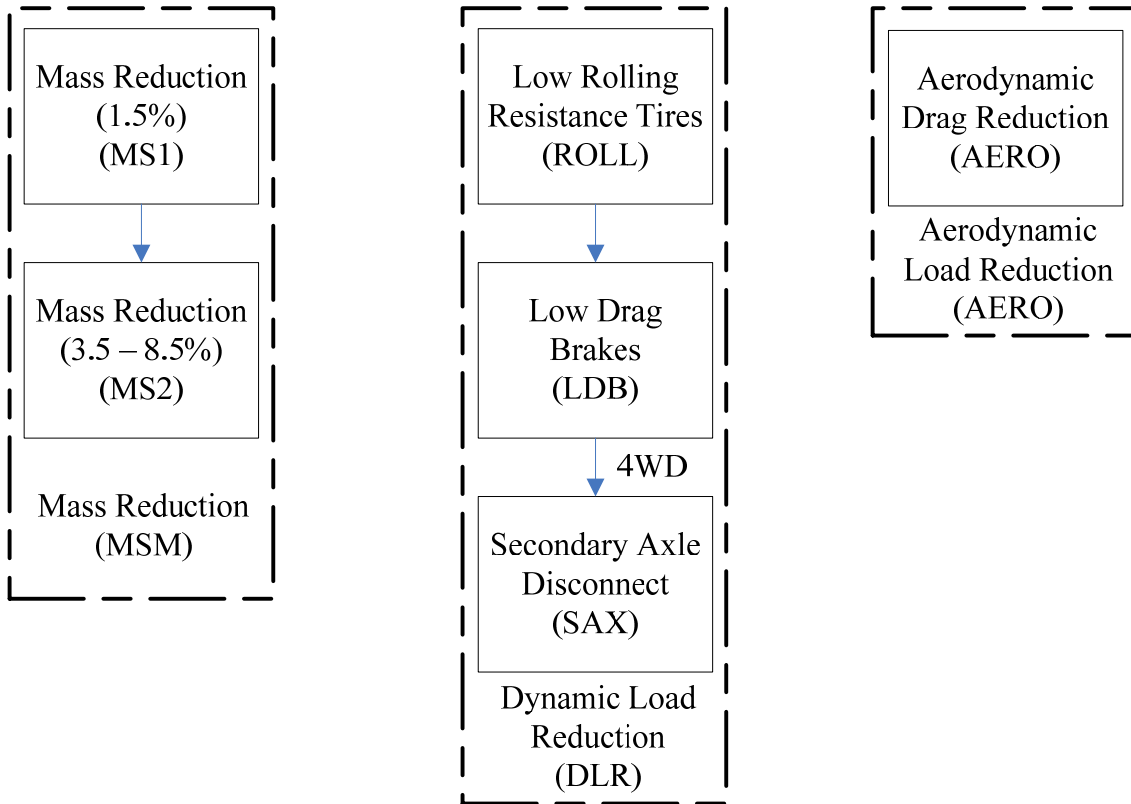

4. Division of vehicles into subclasses based on technology applicability, cost and effectiveness

As part of its consideration of technological feasibility, the agency evaluates whether each technology could be implemented on all types and sizes of vehicles, and whether some differentiation is necessary in applying certain technologies to certain types and sizes of vehicles, and with respect to the cost incurred and fuel consumption and CO₂ emissions reduction achieved when doing so. The 2002 NAS Report differentiated technology application using ten vehicle “classes” (4 cars classes and 6 truck classes),⁸⁶ but did not determine how cost and effectiveness values differ from class to class. NAS’s purpose in separating vehicles into these classes was to create groups of “like” vehicles, *i.e.*, vehicles similar in size, powertrain configuration, weight, and consumer use, and for which similar technologies are applicable. NHTSA similarly differentiates vehicles, referring to each grouping as a “subclass,” for the purpose of applying technologies to vehicles and assessing their incremental costs and effectiveness. These technology subclasses should not be confused with the regulatory classifications pursuant to 49 CFR Part 523.

For this NPRM as for the MY 2011 final rule, the CAFE model divides the vehicle fleet into subclasses based on model inputs, and applies subclass-specific estimates, also from model inputs, of the applicability, cost, and effectiveness of each fuel-saving technology. Therefore, the model’s estimates of the cost to improve the fuel economy of each vehicle model depend upon the subclass to which the vehicle model is assigned.

NHTSA’s analysis for the MY 2005-2007 and MY 2008-2011 light truck CAFE standards used the same vehicle classes defined by NAS in its 2002 Report. The 2008 NPRM for MY 2011-2015 also used those same vehicle classes, but included some differentiation in cost and effectiveness numbers between the various classes to account for differences in technology costs and effectiveness that are observed when technologies are applied on to different classes and subclasses of vehicles. The agency found it important to make that differentiation because it estimated that, for example, engine turbocharging and downsizing would have different implications for large vehicles than for smaller vehicles. However, for purposes of this proposal, NHTSA closely re-examined the subclasses used for the MY 2011 final rule and found that the methodology and subclasses used then, which had been developed in response to comments arguing insufficient differentiation, remain appropriate for the MY 2012-2016 vehicles under consideration. The methodology is as follows:

NHTSA examined the car and truck segments separately. First, for the car segment, NHTSA plotted the footprint distribution of vehicles in the baseline vehicle fleet and divided that distribution into four equivalent footprint range segments. The footprint ranges were named Subcompact, Compact, Midsize, and Large classes in ascending order. Cars were then assigned to one of these classes based on their specific footprint size. Vehicles in each range were then manually reviewed by NHTSA staff to evaluate and confirm that they represented a fairly reasonable homogeneity of size, weight, powertrains, consumer use, etc. However, each group contained some vehicles that were sports or high-performance models. Since different technologies and cost and

⁸⁶ The NAS classes included subcompact cars, compact cars, midsize cars, large cars, small SUVs, midsize SUVs, large SUVs, small pickups, large pickups, and minivans.

effectiveness estimates may be appropriate for these type vehicles, NHTSA employed a performance subclass within each car subclass to maximize the accuracy of technology application. To determine which specific cars would be assigned to the performance subclasses, NHTSA graphed (in ascending rank order) the power-to-weight ratio for each vehicle in a subclass. An example of the Compact subclass plot is shown below. The subpopulation was then manually reviewed by NHTSA staff to determine an appropriate transition point between “performance” and “non-performance” models within each class.

Figure V-11

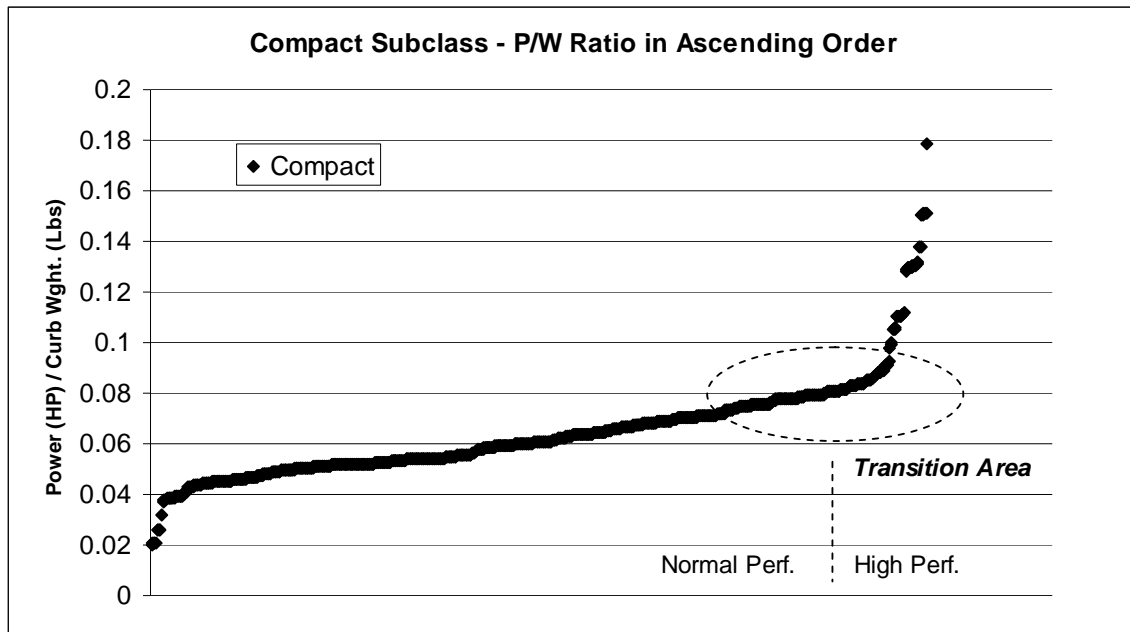

A total of eight classes (including performance subclasses) were identified for the car segment: Subcompact, Subcompact Performance, Compact, Compact Performance, Midsize, Midsize Performance, Large and Large Performance. In total, the number of cars that were ultimately assigned to a performance subclass was less than 10 percent. The table below provides examples of the types of vehicles assigned to each car subclass.

Table V-8 Passenger Car Subclasses Example (MY 2008) Vehicles

Class	Example vehicles
Subcompact	Chevy Aveo, Honda Civic
Subcompact Performance	Mazda Miata, Saturn Sky
Compact	Chevy Cobalt, Nissan Sentra and Altima
Compact Performance	Audi S4 Quattro, Mazda RX8
Midsize	Chevy Camaro (V6), Toyota Camry, Honda Accord, Hyundai Azera
Midsize Performance	Chevy Corvette, Ford Mustang (V8), Nissan G37 Coupe

Large	Audi A8, Cadillac CTS and DTS
Large Performance	Bentley Arnage, Daimler CL600

For light trucks, as in the MY 2011 final rule, NHTSA found less of a distinction in the anticipated vehicle fleet during the model years covered by the rulemaking between SUVs and pickup trucks than appeared to exist in earlier rulemakings. We anticipate fewer ladder-frame and more unibody pickups, and that many pickups will share common powertrains with SUVs. Thus, SUVs and pickups are grouped in the same subclasses. Additionally, it made sense to carry forward NHTSA's decision from the MY 2011 final rule to employ a separate minivan class, because minivans (*e.g.*, the Honda Odyssey) are more car-like and differ significantly in terms of structural and other engineering characteristics as compared to other vans (*e.g.*, Ford's E-Series—also known as Econoline—vans) intended for more passengers and/or heavier cargo and which are more truck-like.

Thus, the remaining vehicles (other vans, pickups, and SUVs) were then segregated into three footprint ranges and assigned a class of Small Truck/SUV, Midsize Truck/SUV, and Large Truck/SUV based on their footprints. NHTSA staff then manually reviewed each population for inconsistent vehicles based on engine cylinder count, weight (curb and/or gross), or intended usage, since these are important considerations for technology application, and reassigned vehicles to classes as appropriate. This system produced four truck segment subclasses—minivans and small, medium, and large SUVs/Pickups/Vans. The table below provides examples of the types of vehicles assigned to each truck subclass.

Table V-9 Light Truck Subclasses Example (MY 2008) Vehicles

Class	Example vehicles
Minivans	Dodge Caravan, Toyota Sienna
Small SUV/Pickup/Van	Ford Escape & Ranger, Nissan Rogue
Midsize SUV/Pickup/Van	Chevy Colorado, Jeep Wrangler 4-door, Volvo XC70, Toyota Tacoma
Large SUV/Pickup/Van	Chevy Silverado, Ford Econoline, Toyota Sequoia

As mentioned above, NHTSA employed this method for assigning vehicle subclasses for this NPRM after reviewing the process used in the MY 2011 final rule and concluding that it continued to be a reasonable approach for purposes of this rulemaking. NHTSA believes that this method substantially improves the overall accuracy of the results as compared to systems employed previously, due to the close manual review by NHTSA staff to ensure proper assignments, the use of performance subclasses in the car segment, and the condensing of subclasses in the truck segment, all of which further refine the system without overly complicating the CAFE modeling process. Nevertheless, NHTSA invites comments on the method of assigning vehicles to subclasses for the purposes of technology application in the CAFE model, and on the issue of technology-application subclasses generally.

5. How did NHTSA develop technology cost and effectiveness estimates for the NPRM?

Building on NHTSA's estimates developed for the MY 2011 final rule and EPA's Advanced Notice of Proposed Rulemaking, which relied on the 2008 Staff Technical Report,⁸⁷ the agencies took a fresh look at technology cost and effectiveness values for purposes of the joint proposal under the National Program. For costs, the agencies reconsidered both the direct or "piece" costs and indirect costs of individual components of technologies. For the direct costs, the agencies followed a bill of materials (BOM) approach employed by NHTSA in NHTSA's MY 2011 final rule based on recommendation from Ricardo, Inc. Ricardo was hired by NHTSA, as discussed previously, to aid in the analysis of public comments on its proposed standards for MYs 2011-2015 because of its expertise in the area of fuel economy technologies. A BOM, in a general sense, is a list of components that make up a system—in this case, an item of fuel economy-improving technology. The BOM approach is similar in concept to the approach used in tear down studies. In order to determine what a system costs, one of the first steps is to determine its components and what they cost.

NHTSA and EPA estimated these components and their costs based on a number of sources for cost-related information. The objective was to use those sources of information considered to be most credible for projecting the costs of individual vehicle technologies. For example, while NHTSA and Ricardo engineers had relied considerably in the MY 2011 final rule on the 2008 Martec Report for costing contents of some technologies, upon further joint review and for purposes of the MY 2012-2016 standards, the agencies decided that some of the costing information in that report was no longer accurate due to downward trends in commodity prices since the publication of that report. The agencies reviewed, revalidated or updated cost estimates for individual components based on new information. Thus while NHTSA and EPA found that much of the cost information used in NHTSA's MY 2011 final rule and EPA's staff report was consistent to a great extent, the agencies, in reconsidering information from many sources,⁸⁸ revised several component costs of several major technologies information (turbocharging downsizing, mild and strong hybrids, diesels, SGDI, Valve Train Lift Technologies). These are discussed at length below. For one technology (turbocharging/downsizing), the agencies relied, to the extent possible, on the tear down data available and scaling methodologies used in EPA's ongoing study with FEV Inc., an independent engine and powertrain systems research, design and development company. This study consists of complete system tear-down to evaluate technologies down to the nuts and bolts to arrive at very detailed estimates of the costs associated with manufacturing them.⁸⁹ The confidential information provided by manufacturer under their product plan submissions

⁸⁷ EPA Staff Technical Report: Cost and Effectiveness Estimates of Technologies Used to Reduce Light-Duty Vehicle Carbon Dioxide Emissions. EPA420-R-08-008, March 2008.

⁸⁸ the 2002 NAS Report,⁸⁸ the 2004 study done by NESCCAF,⁸⁸ the California Air Resources Board (CARB) Initial Statement of Reasons in support of their carbon rulemaking,⁸⁸ a 2006 study done by Energy and Environmental Analysis (EEA) for the Department of Energy,⁸⁸ a study done by Martec for the Alliance of Automobile Manufacturers and the 2008 Martec Report which updated that study,⁸⁸ and vehicle fuel economy certification data. and confidential data submitted by manufacturers in response to the March 2009 request for product plans.

⁸⁹ "Draft Report – Light-Duty Technology Cost Analysis Pilot Study," U.S. Environmental Protection Agency, Contract No. EP-C-07-069, Work Assignment 1-3, September 3, 2009

to the agencies or discussed in meetings between the agencies and the manufacturers and suppliers served largely as a check on publicly-available data.

For the other technologies, because tear down studies were not yet available, the agencies decided to pursue the (BOM) approach considering all sources of information. The agencies worked together intensively during the summer of 2009 to determine component costs for each of the technologies and build up the costs accordingly. Where estimates differ between sources, we have used engineering judgment to arrive at what we believe to be the best cost estimate available today, and explained the basis for that exercise of judgment.

Once costs were determined, they were adjusted to ensure that they were all expressed in 2007 dollars using a ratio of GDP values for the associated calendar years,⁹⁰ and indirect costs were accounted for using the new approach developed by EPA for this rulemaking and explained in the joint TSD, rather than using the traditional Retail Price Equivalent (RPE) multiplier of 1.5. This report can be found in the docket for this notice. NHTSA and EPA also considered how costs should be adjusted by modifying or scaling content assumptions to account for differences across the range of vehicle sizes and functional requirements, and adjusted the associated material cost impacts to account for the revised content, although these adjustments were different for each agency due to the different vehicle subclasses used in their respective models.

Regarding estimates for technology effectiveness, NHTSA in coordination with EPA also reexamined the estimates from NHTSA's MY 2011 CAFE final rule and EPA's ANPRM and Staff Technical Report, which largely mirrored NHTSA's NPRM estimates in the 2008 proposed rule. The agencies also reconsidered other sources such as the 2002 NAS Report, the 2004 NESCCAF report and recent CAFE compliance data. Using the BOM framework utilized in MY 2011 CAFE final rule, NHTSA and EPA engineers reviewed effectiveness information from the multiple sources for each technology. Together, they compared the multiple estimates and assessed their validity, taking care to ensure that common BOM definitions and other vehicle attributes such as performance, refinement, and drivability were taken into account. However, because the agencies' respective models employ different numbers of vehicle subclasses and use different technology decision trees to arrive at the standards, direct comparison of technologies was somewhat more complicated. To address this and to assure an apples-to-apple comparison, NHTSA and EPA developed mapping techniques, devising technology packages and corresponding incremental technology estimates. This approach helped compare incremental and packaged estimates and derive results that are consistent and could be translated into the respective models of the agencies. In general, most effectiveness estimates used in both the MY 2011 CAFE final rule and the 2008 EPA staff report were determined to be accurate and were carried forward without significant change into this rulemaking. When NHTSA and EPA's estimates for effectiveness diverged slightly due differences in how agencies apply technologies to vehicles in their respective models, the agencies will report the ranges for the effectiveness values used in each model, as well as the reasons the range is reasonable.

6. Learning curves

⁹⁰ NHTSA examined the use of the CPI multiplier instead of GDP for adjusting these dollar values, but found the difference to be exceedingly small – only \$0.14 over \$100.

In the MY 2011 CAFE final rule and its related 2008 proposal, NHTSA accounted for the cost reductions manufacturers realized through experiential learning achieved through applying technologies. NHTSA continues to account for these cost reductions in this proposal through the use of two mutually exclusive learning types, “volume-based” and “time-based,” as discussed below.

In the 2008 NPRM, working in conjunction with the EPA, NHTSA applied learning factors to technology costs for the first time. The factors were developed using the three parameters of learning threshold, learning rate, and the initial technology cost, and were based on the “experience curve” concept which describes reductions in production costs as a function of accumulated production volume. The typical curve shows a relatively steep initial decline in cost which flattens out to a gentle downwardly sloping line as the volume increase to large values. In the NPRM, NHTSA applied a learning rate discount of 20 percent for each successive doubling of production volume (on a per manufacturer basis), and a learning threshold of 25,000 units was assumed (thus a technology was viewed as being fully learned out at 100,000 units). The factor was only applied to certain technologies that were considered emerging or newly implemented on the basis that significant cost improvements would be achieved as economies of scale were realized (*i.e.*, the technologies were on the steep part of the curve).

In the MY 2011 final rule, NHTSA continued to use this learning factor, referring to it as volume-based learning since the cost reductions were determined by production volume increases, and again only applied it to low volume, emerging technologies. However, and in response to comments, NHTSA revised its assumptions on learning threshold, basing them instead on an industry-wide production basis, and increasing the threshold to 300,000 units annually (and thus a technology is considered to be fully learned out at 1.2M annual units).

However commenters to the 2008 NPRM also described another type of learning factor which NHTSA, working in conjunction with its contractor Ricardo, Inc who assisted in finalizing the rule, adopted and implemented in the MY 2011 final rule. Commenters described a relatively small negotiated cost decrease that occurred on an annual basis through contractual agreements with first tier component and systems suppliers. These agreements were generally only applicable to readily available, high volume technologies that were commonly in use by multiple OEMs. Based on the same experience curve principal, however at production volumes that were on the extended, flatter part of the curve (and thus the types of volumes that more accurately represent an annual industry-wide production volume), NHTSA adopted this type learning and referred to it as time-based learning. An annual cost reduction of 3 percent in the second and each subsequent year, which was consistent with estimates from commenters and supported by work Ricardo conducted for NHTSA, was used in the 2011 final rule.

In developing this proposal, NHTSA has reviewed both types of learning factors, and the thresholds (300,000) and cost reduction rates (20 percent for volume, 3 percent for time-based) they rely on, as implemented in the MY 2011 final rule, and has concluded that both learning factors continue to be accurate and appropriate. NHTSA therefore continues to implement both time- and volume-based learning in the analyses that supports this proposal. Noting that only one type of learning can be applied to any

single technology, if any learning is applied at all, NHTSA reviewed each technology to determine which if any learning factor was appropriate.

Working under the principal that volume-based learning is applicable to lower volume, higher complexity, emerging technologies while time-based learning is appropriate for high volume, established and readily available technologies, NHTSA determined the learning factors shown in Table V-10 below. These factors, which were used in this analysis, closely resemble the settings used in the 2011 final rule with the exception of PSHEV which has been revised from time-based to volume-based learning. Note that no learning is applied to technologies which are potentially affected by commodity costs (LUB, ROLL) or that have loosely-defined BOMs (EFR, LDB) in the this analysis, as was also the case in the MY 2011 final rule analysis. Where volume-based learning has been applied, NHTSA has taken great care to ensure that the initial costs (before learning is applied) properly reflect low volume, unlearned cost estimates (*i.e.*, any high volume cost estimates used in the analysis have been appropriately “reverse learned” so as not to underestimate the final learned costs).

Table V-10 Application of learning-related cost reductions for technologies

Technology	Model Abbreviation	Learning Type	Learning Rate
Low Friction Lubricants	LUB		
Engine Friction Reduction	EFR		
VVT - Coupled Cam Phasing (CCP) on SOHC	CCPS	TIME	3%
Discrete Variable Valve Lift (DVVL) on SOHC	DVVLS	TIME	3%
Cylinder Deactivation on SOHC	DEACS	TIME	3%
VVT - Intake Cam Phasing (ICP)	ICP	TIME	3%
VVT - Dual Cam Phasing (DCP)	DCP	TIME	3%
Discrete Variable Valve Lift (DVVL) on DOHC	DVVLD	TIME	3%
Continuously Variable Valve Lift (CVVL)	CVVL	TIME	3%
Cylinder Deactivation on DOHC	DEADD	TIME	3%
Cylinder Deactivation on OHV	DEACO	TIME	3%
VVT - Coupled Cam Phasing (CCP) on OHV	CCPO	TIME	3%
Discrete Variable Valve Lift (DVVL) on OHV	DVVLO	TIME	3%
Conversion to DOHC with DCP	CDOHC	TIME	3%
Stoichiometric Gasoline Direct Injection (GDI)	SGDI	TIME	3%
Combustion Restart	CBRST	TIME	3%
Turbocharging and Downsizing	TRBDS	TIME	3%
Exhaust Gas Recirculation (EGR) Boost	EGRB	TIME	3%
Conversion to Diesel following CBRST	DSLK	TIME	3%
Conversion to Diesel following TRBDS	DSLK	TIME	3%
6-Speed Manual/Improved Internals	6MAN	TIME	3%
Improved Auto. Trans. Controls/Externals	IATC	TIME	3%
Continuously Variable Transmission	CVT	TIME	3%
6/7/8-Speed Auto. Trans with Improved Internals	NAUTO	TIME	3%
Dual Clutch or Automated Manual Transmission	DCTAM	TIME	3%
Electric Power Steering	EPS	TIME	3%
Improved Accessories	IACC	TIME	3%
12V Micro-Hybrid	MHEV	TIME	3%
Belt Integrated Starter Generator	BISG	VOLUME	20%
Crank Integrated Starter Generator	CISG	VOLUME	20%
Power Split Hybrid	PSHEV	VOLUME	20%
2-Mode Hybrid	2MHEV	VOLUME	20%
Plug-in Hybrid	PHEV	VOLUME	20%
Mass Reduction 1 (1.5%)	MS1		
Mass Reduction 2 (3.5% – 8.5%)	MS2		
Low Rolling Resistance Tires	ROLL		
Low Drag Brakes	LDB		
Secondary Axle Disconnect 4WD	SAX	TIME	3%
Aero Drag Reduction	AERO	TIME	3%

7. Technology synergies

When two or more technologies are added to a particular vehicle model to improve its fuel efficiency, the resultant fuel consumption reduction may sometimes be higher or lower than the product of the individual effectiveness values for those items.⁹¹ This may occur because one or more technologies applied to the same vehicle partially address the same source (or sources) of engine, drivetrain or vehicle losses. Alternately, this effect may be seen when one technology shifts the engine operating points, and therefore increases or reduces the fuel consumption reduction achieved by another technology or set of technologies. The difference between the observed fuel consumption reduction associated with a set of technologies and the product of the individual effectiveness values in that set is referred to as a “synergy.” Synergies may be positive (increased fuel consumption reduction compared to the product of the individual effects) or negative (decreased fuel consumption reduction). An example of a positive synergy might be a vehicle technology that reduces road loads at highway speeds (*e.g.*, lower aerodynamic drag or low rolling resistance tires), that could effectively extend the vehicle operating range over which cylinder deactivation may be employed, thus allowing a greater fuel consumption reduction than anticipated or predicted by analysis. An example of a negative synergy might be a variable valvetrain technology, which reduces pumping losses by altering the profile of the engine speed/load map, and a six-speed automatic transmission, which shifts the engine operating points to a portion of the engine speed/load map where pumping losses are less significant, leaving less opportunity for the combined technologies to decrease fuel consumption. As the complexity of the technology combinations is increased, and the number of interacting technologies grows accordingly, it becomes increasingly important to account for these synergies.

NHTSA determined synergistic impacts for this rulemaking using EPA’s “lumped parameter” analysis tool, which EPA described at length in its March 2008 Staff Technical Report.⁹² The lumped parameter tool is a spreadsheet model that represents energy consumption in terms of average performance over the fuel economy test procedure, rather than explicitly analyzing specific drive cycles. The tool begins with an apportionment of fuel consumption across several loss mechanisms and accounts for the average extent to which different technologies affect these loss mechanisms using estimates of engine, drivetrain and vehicle characteristics that are averaged over the EPA fuel economy drive cycle. Results of this analysis were generally consistent with those of full-scale vehicle simulation modeling performed in 2007 by Ricardo, Inc. However, regardless of a generally consistent set of results for the vehicle class and set of technologies studied, the lumped parameter tool is not a full vehicle simulation and

⁹¹ More specifically, the resultant is calculated as the products of the differences between the numeric value one (*i.e.*, 1.0) and the technology-specific levels of effectiveness in reducing fuel consumption (expressed as a numeric value also, *i.e.*, 10% = 0.10). For example, not accounting for interactions, if technologies A and B are estimated to reduce fuel consumption by 10% (*i.e.*, 0.1) and 20% (*i.e.*, 0.2) respectively, the “product of the individual effectiveness values” would be (1 – 0.1) times (1 – 0.2), or 0.9 times 0.8, which equals 0.72, corresponding to a combined effectiveness of (1 - .72 = .28) or 28% rather than the 30% obtained by adding 10% to 20%. The “synergy factors” discussed in this section further adjust these multiplicatively combined effectiveness values.

⁹² EPA Staff Technical Report: Cost and Effectiveness Estimates of Technologies Used to Reduce Light-duty Vehicle Carbon Dioxide Emissions; EPA420-R-08-008, March 2008.

cannot replicate the physics of such a simulation.

Because NHTSA applies technologies individually in its modeling analysis, NHTSA incorporates synergistic effects between pairings of individual technologies. The use of discrete technology pair incremental synergies is similar to that in DOE's National Energy Modeling System (NEMS).⁹³ Inputs to the Volpe model incorporate NEMS-identified pairs, as well as additional pairs from the set of technologies considered in the Volpe model. For the current rulemaking, as was the case in the 2011 final rule, NHTSA used the lumped parameter tool to evaluate accurate synergy values. During the 2011 final rule analysis, and with the assistance of Ricardo, NHTSA modified the lumped parameter tool by updating the list of technologies and their associated effectiveness values, and expanding the list of synergy pairings based on further consideration of the technologies for which a competition for losses would be expected, for the purposes of evaluating appropriate synergy values. Table V-11 below presents the types of losses that were analyzed.

NHTSA notes that synergies that occur within a particular decision tree are already accounted for within the incremental effectiveness values assigned for each technology, and therefore additional synergy pairs for these technologies are not required. For example, all engine technologies take into account the synergies that occur with the preceding/existing engine technologies, and all transmission technologies take into account synergies of preceding transmission technologies, etc. These synergy factors are accounted for in the fuel consumption improvement estimates in the input files used by the Volpe model.

For applying incremental synergy factors in separate path technologies, i.e., between two or more decision trees, the Volpe model uses an input table (see Tables V-12 a-d) which lists technology pairings and incremental synergy factors associated with those pairings (most of which are between engine technologies and transmission/electrification/hybrid technologies). When a technology is applied to a vehicle by the Volpe model, all instances of that technology in the incremental synergy table which match technologies already applied to the vehicle (either pre-existing or previously applied by the Volpe model) are summed and applied to the fuel consumption improvement factor of the technology being applied. Synergies for the strong hybrid technology fuel consumption reductions are included in the incremental value for the specific hybrid technology since the model applies technologies in the order of the most effectiveness for least cost and also applies all available electrification and transmission technologies before applying strong hybrid technologies.

⁹³ U.S. Department of Energy, Energy Information Administration, *Transportation Sector Module of the National Energy Modeling System: Model Documentation 2007*, May 2007, Washington, DC, DOE/EIA-M070(2007), at 29-30. Available at [http://tonto.eia.doe.gov/ftp/root/modeldoc/m070\(2007\).pdf](http://tonto.eia.doe.gov/ftp/root/modeldoc/m070(2007).pdf) (last accessed Jul. 6, 2009).

Table V-11 Loss Factors Considered in Synergy Analysis

Lumped Parameter Synergy Analysis						
	VEHICLE Tractive Effort	TRANS Drivetrain Losses	ENGINE Mechanical Friction	ENGINE Pumping Losses	ENGINE Accessory Losses	ENGINE Indicated Efficiency
ENGINE						
Low Friction Lubricants			+			
Engine Friction Reduction			+			
VVT - Coupled Cam Phasing (CCP) on SOHC			-	+		+
Discrete Variable Valve Lift (DVVL) on SOHC			-	+		
Cylinder Deactivation on SOHC			+	+		
VVT - Intake Cam Phasing (ICP)			-	+		+
VVT - Dual Cam Phasing (DCP)			-	+		+
Discrete Variable Valve Lift (DVVL) on DOHC			-	+		
Continuously Variable Valve Lift (CVVL)			-	+		
Cylinder Deactivation on DOHC			+	+		
Cylinder Deactivation on OHV			+	+		
VVT - Coupled Cam Phasing (CCP) on OHV			-	+		+
Discrete Variable Valve Lift (DVVL) on OHV			-	+		
Conversion to DOHC with DCP			-	+		+
Stoichiometric Gasoline Direct Injection (GDI)						+
Combustion Restart			+	+	+	
Turbocharging and Downsizing			-	+		
Exhaust Gas Recirculation (EGR) Boost						+
Conversion to Diesel				+		+
TRANSMISSION (MANUAL)						
6-Speed Manual/Improved Internals		+		+		
TRANSMISSION (AUTOMATIC)						
Improved Auto. Trans. Controls/Externals		+		+		
Continuously Variable Transmission		-		+		
6/7/8-Speed Auto. Trans with Impr. Internals		+		+		
Dual Clutch/Automated Manual Transmission		+				
ELECTRIFICATION/ACCESSORY						
Electric Power Steering					+	
Improved Accessories					+	
12V Micro-Hybrid			+	+	+	
Belt Integrated Starter Generator			+	+	+	
Crank Integrated Starter Generator			+	+	+	
(STRONG) HYBRID						
Power Split Hybrid		+	+	+	+	
2-Mode Hybrid		+	+	+	+	
Plug-in Hybrid		+	+	+	+	
VEHICLE						
Mass Reduction 1 (1.5%)	+					
Mass Reduction 2 (3.5% - 8.5%)	+					
Low Rolling Resistance Tires	+					
Low Drag Brakes	+					
Secondary Axle Disconnect - 4WD		+				
Aero Drag Reduction	+					

+ Technology has a positive effect on fuel consumption

- Technology has a negative effect on fuel consumption

Table V-12a Synergy pairings and values

Synergies		Fuel Consumption Improvement Synergy values by Vehicle Subclass Positive values are positive synergies, negative values are dissynergies.					
Technology A	Technology B	Subcompact PC	Subcompact Perf. PC	Compact PC	Compact Perf. PC	Midsized PC	Midsized Perf. PC
CCPS	6MAN	-0.1%	-0.1%	-0.1%	-0.1%	-0.1%	-0.1%
CCPS	IATC	-0.2%	-0.2%	-0.2%	-0.2%	-0.2%	-0.2%
CCPS	CVT	-0.8%	-0.8%	-0.8%	-0.8%	-0.8%	-0.8%
CCPS	NAUTO	-0.4%	-0.4%	-0.4%	-0.4%	-0.4%	-0.4%
CCPS	MHEV	-0.7%	-0.7%	-0.7%	-0.7%	-0.7%	-0.7%
CCPS	BISG	-0.9%	-0.9%	-0.9%	-0.9%	-0.9%	-0.9%
DVVLS	6MAN	-0.1%	-0.1%	-0.1%	-0.1%	-0.1%	-0.1%
DVVLS	IATC	-0.5%	-0.5%	-0.5%	-0.5%	-0.5%	-0.5%
DVVLS	CVT	-1.4%	-1.4%	-1.4%	-1.4%	-1.4%	-1.4%
DVVLS	NAUTO	-0.7%	-0.7%	-0.7%	-0.7%	-0.7%	-0.7%
DVVLS	MHEV	-0.8%	-0.8%	-0.8%	-0.8%	-0.8%	-0.8%
DVVLS	BISG	-1.0%	-1.0%	-1.0%	-1.0%	-1.0%	-1.0%
DEACS	6MAN	-0.2%	-0.2%	-0.2%	-0.2%	-0.2%	-0.2%
DEACS	IATC	-0.6%	-0.6%	-0.6%	-0.6%	-0.6%	-0.6%
DEACS	CVT	-1.7%	-1.7%	-1.7%	-1.7%	-1.7%	-1.7%
DEACS	NAUTO	-0.9%	-0.9%	-0.9%	-0.9%	-0.9%	-0.9%
DEACS	MHEV	-0.9%	-0.9%	-0.9%	-0.9%	-0.9%	-0.9%
DEACS	BISG	-1.1%	-1.1%	-1.1%	-1.1%	-1.1%	-1.1%
ICP	6MAN	-0.1%	-0.1%	-0.1%	-0.1%	-0.1%	-0.1%
ICP	IATC	-0.2%	-0.2%	-0.2%	-0.2%	-0.2%	-0.2%
ICP	CVT	-0.8%	-0.8%	-0.8%	-0.8%	-0.8%	-0.8%
ICP	NAUTO	-0.4%	-0.4%	-0.4%	-0.4%	-0.4%	-0.4%
ICP	MHEV	-0.7%	-0.7%	-0.7%	-0.7%	-0.7%	-0.7%
ICP	BISG	-0.9%	-0.9%	-0.9%	-0.9%	-0.9%	-0.9%
DCP	6MAN	-0.1%	-0.1%	-0.1%	-0.1%	-0.1%	-0.1%
DCP	IATC	-0.4%	-0.4%	-0.4%	-0.4%	-0.4%	-0.4%
DCP	CVT	-1.3%	-1.3%	-1.3%	-1.3%	-1.3%	-1.3%
DCP	NAUTO	-0.7%	-0.7%	-0.7%	-0.7%	-0.7%	-0.7%
DCP	MHEV	-0.8%	-0.8%	-0.8%	-0.8%	-0.8%	-0.8%
DCP	BISG	-1.0%	-1.0%	-1.0%	-1.0%	-1.0%	-1.0%
DVVLD	6MAN	-0.2%	-0.2%	-0.2%	-0.2%	-0.2%	-0.2%
DVVLD	IATC	-0.6%	-0.6%	-0.6%	-0.6%	-0.6%	-0.6%
DVVLD	CVT	-1.8%	-1.8%	-1.8%	-1.8%	-1.8%	-1.8%
DVVLD	NAUTO	-1.0%	-1.0%	-1.0%	-1.0%	-1.0%	-1.0%
DVVLD	MHEV	-0.9%	-0.9%	-0.9%	-0.9%	-0.9%	-0.9%
DVVLD	BISG	-1.1%	-1.1%	-1.1%	-1.1%	-1.1%	-1.1%
DEACD	6MAN	-0.2%	-0.2%	-0.2%	-0.2%	-0.2%	-0.2%
DEACD	IATC	-0.6%	-0.6%	-0.6%	-0.6%	-0.6%	-0.6%
DEACD	CVT	-1.8%	-1.8%	-1.8%	-1.8%	-1.8%	-1.8%
DEACD	NAUTO	-1.0%	-1.0%	-1.0%	-1.0%	-1.0%	-1.0%
DEACD	MHEV	-0.9%	-0.9%	-0.9%	-0.9%	-0.9%	-0.9%
DEACD	BISG	-1.1%	-1.1%	-1.1%	-1.1%	-1.1%	-1.1%
CVVL	6MAN	-0.2%	-0.2%	-0.2%	-0.2%	-0.2%	-0.2%
CVVL	IATC	-0.6%	-0.6%	-0.6%	-0.6%	-0.6%	-0.6%
CVVL	CVT	-1.8%	-1.8%	-1.8%	-1.8%	-1.8%	-1.8%
CVVL	NAUTO	-1.0%	-1.0%	-1.0%	-1.0%	-1.0%	-1.0%
CVVL	MHEV	-0.9%	-0.9%	-0.9%	-0.9%	-0.9%	-0.9%
CVVL	BISG	-1.1%	-1.1%	-1.1%	-1.1%	-1.1%	-1.1%
DEACO	6MAN	-0.1%	-0.1%	-0.1%	-0.1%	-0.1%	-0.1%
DEACO	IATC	-0.5%	-0.5%	-0.5%	-0.5%	-0.5%	-0.5%
DEACO	CVT	-1.4%	-1.4%	-1.4%	-1.4%	-1.4%	-1.4%
DEACO	NAUTO	-0.8%	-0.8%	-0.8%	-0.8%	-0.8%	-0.8%
DEACO	MHEV	-0.9%	-0.9%	-0.9%	-0.9%	-0.9%	-0.9%
DEACO	BISG	-1.2%	-1.2%	-1.2%	-1.2%	-1.2%	-1.2%

Table V-12b Synergy pairings and values

Synergies		Fuel Consumption Improvement Synergy values by Vehicle Subclass Positive values are positive synergies, negative values are dissynergies.					
Technology A	Technology B	Subcompact PC	Subcompact Perf. PC	Compact PC	Compact Perf. PC	Midsized PC	Midsized Perf. PC
CCPO	6MAN	-0.2%	-0.2%	-0.2%	-0.2%	-0.2%	-0.2%
CCPO	IATC	-0.6%	-0.6%	-0.6%	-0.6%	-0.6%	-0.6%
CCPO	CVT	-1.7%	-1.7%	-1.7%	-1.7%	-1.7%	-1.7%
CCPO	NAUTO	-0.9%	-0.9%	-0.9%	-0.9%	-0.9%	-0.9%
CCPO	MHEV	-1.0%	-1.0%	-1.0%	-1.0%	-1.0%	-1.0%
CCPO	BISG	-1.1%	-1.1%	-1.1%	-1.1%	-1.1%	-1.1%
DVVLO	6MAN	-0.2%	-0.2%	-0.2%	-0.2%	-0.2%	-0.2%
DVVLO	IATC	-0.7%	-0.7%	-0.7%	-0.7%	-0.7%	-0.7%
DVVLO	CVT	-2.0%	-2.0%	-2.0%	-2.0%	-2.0%	-2.0%
DVVLO	NAUTO	-1.1%	-1.1%	-1.1%	-1.1%	-1.1%	-1.1%
DVVLO	MHEV	-1.0%	-1.0%	-1.0%	-1.0%	-1.0%	-1.0%
DVVLO	BISG	-1.1%	-1.1%	-1.1%	-1.1%	-1.1%	-1.1%
CDOHC	6MAN	-0.2%	-0.2%	-0.2%	-0.2%	-0.2%	-0.2%
CDOHC	IATC	-0.7%	-0.7%	-0.7%	-0.7%	-0.7%	-0.7%
CDOHC	CVT	-2.0%	-2.0%	-2.0%	-2.0%	-2.0%	-2.0%
CDOHC	NAUTO	-1.1%	-1.1%	-1.1%	-1.1%	-1.1%	-1.1%
CDOHC	MHEV	-1.0%	-1.0%	-1.0%	-1.0%	-1.0%	-1.0%
CDOHC	BISG	-1.1%	-1.1%	-1.1%	-1.1%	-1.1%	-1.1%
CBRST	6MAN	-0.2%	-0.2%	-0.2%	-0.2%	-0.2%	-0.2%
CBRST	IATC	-0.6%	-0.6%	-0.6%	-0.6%	-0.6%	-0.6%
CBRST	CVT	-1.8%	-1.8%	-1.8%	-1.8%	-1.8%	-1.8%
CBRST	NAUTO	-1.1%	-1.1%	-1.1%	-1.1%	-1.1%	-1.1%
CBRST	BISG	-1.1%	-1.1%	-1.1%	-1.1%	-1.1%	-1.1%
CBRST	EPS	-0.2%	-0.2%	-0.2%	-0.2%	-0.2%	-0.2%
CBRST	IACC	-0.4%	-0.4%	-0.4%	-0.4%	-0.4%	-0.4%
TRBDS	6MAN	-0.2%	-0.2%	-0.2%	-0.2%	-0.2%	-0.2%
TRBDS	IATC	-0.7%	-0.7%	-0.7%	-0.7%	-0.7%	-0.7%
TRBDS	CVT	-2.4%	-2.4%	-2.4%	-2.4%	-2.4%	-2.4%
TRBDS	NAUTO	-1.3%	-1.3%	-1.3%	-1.3%	-1.3%	-1.3%
TRBDS	MHEV	-1.1%	-1.1%	-1.1%	-1.1%	-1.1%	-1.1%
TRBDS	BISG	-1.3%	-1.3%	-1.3%	-1.3%	-1.3%	-1.3%
DSLCL	6MAN	-0.3%	-0.3%	-0.3%	-0.3%	-0.3%	-0.3%
DSLCL	IATC	2.5%	2.5%	2.5%	2.5%	2.5%	2.5%
DSLCL	CVT	-2.9%	-2.9%	-2.9%	-2.9%	-2.9%	-2.9%
DSLCL	NAUTO	-1.7%	-1.7%	-1.7%	-1.7%	-1.7%	-1.7%
DSLCL	MHEV	-1.1%	-1.1%	-1.1%	-1.1%	-1.1%	-1.1%
DSLCL	BISG	-1.1%	-1.1%	-1.1%	-1.1%	-1.1%	-1.1%
DSLTL	6MAN	-0.3%	-0.3%	-0.3%	-0.3%	-0.3%	-0.3%
DSLTL	IATC	2.5%	2.5%	2.5%	2.5%	2.5%	2.5%
DSLTL	CVT	-2.9%	-2.9%	-2.9%	-2.9%	-2.9%	-2.9%
DSLTL	NAUTO	-1.7%	-1.7%	-1.7%	-1.7%	-1.7%	-1.7%
DSLTL	MHEV	-1.1%	-1.1%	-1.1%	-1.1%	-1.1%	-1.1%
DSLTL	BISG	-1.1%	-1.1%	-1.1%	-1.1%	-1.1%	-1.1%
CCPS	CISG	-0.9%	-0.9%	-0.9%	-0.9%	-0.9%	-0.9%
DVVLS	CISG	-1.0%	-1.0%	-1.0%	-1.0%	-1.0%	-1.0%
DEACS	CISG	-1.1%	-1.1%	-1.1%	-1.1%	-1.1%	-1.1%
ICP	CISG	-0.9%	-0.9%	-0.9%	-0.9%	-0.9%	-0.9%
DCP	CISG	-1.0%	-1.0%	-1.0%	-1.0%	-1.0%	-1.0%
DVVLD	CISG	-1.1%	-1.1%	-1.1%	-1.1%	-1.1%	-1.1%
DEACD	CISG	-1.1%	-1.1%	-1.1%	-1.1%	-1.1%	-1.1%
CVVL	CISG	-1.1%	-1.1%	-1.1%	-1.1%	-1.1%	-1.1%
DEACO	CISG	-1.2%	-1.2%	-1.2%	-1.2%	-1.2%	-1.2%
CCPO	CISG	-1.1%	-1.1%	-1.1%	-1.1%	-1.1%	-1.1%
DVVLO	CISG	-1.1%	-1.1%	-1.1%	-1.1%	-1.1%	-1.1%
CDOHC	CISG	-1.1%	-1.1%	-1.1%	-1.1%	-1.1%	-1.1%
CBRST	CISG	-1.1%	-1.1%	-1.1%	-1.1%	-1.1%	-1.1%
TRBDS	CISG	-1.3%	-1.3%	-1.3%	-1.3%	-1.3%	-1.3%
DSLCL	CISG	-1.1%	-1.1%	-1.1%	-1.1%	-1.1%	-1.1%
DSLTL	CISG	-1.1%	-1.1%	-1.1%	-1.1%	-1.1%	-1.1%

Table V-12c Synergy pairings and values

Synergies		Fuel Consumption Improvement Synergy values by Vehicle Subclass Positive values are positive synergies, negative values are dissynergies.					
Technology A	Technology B	Large PC	Large Perf. PC	Minivan LT	Small LT	Midsize LT	Large LT
CCPS	6MAN	-0.1%	-0.1%	-0.1%	-0.1%	-0.1%	-0.1%
CCPS	IATC	-0.2%	-0.2%	-0.2%	-0.2%	-0.2%	-0.2%
CCPS	CVT	-0.8%	-0.8%	-0.8%	-0.8%	-0.8%	-0.8%
CCPS	NAUTO	-0.4%	-0.4%	-0.4%	-0.4%	-0.4%	-0.4%
CCPS	MHEV	-0.7%	-0.7%	-0.7%	-0.7%	-0.7%	-0.7%
CCPS	BISG	-0.9%	-0.9%	-0.9%	-0.9%	-0.9%	-0.9%
DVVLS	6MAN	-0.1%	-0.1%	-0.1%	-0.1%	-0.1%	-0.1%
DVVLS	IATC	-0.5%	-0.5%	-0.5%	-0.5%	-0.5%	-0.5%
DVVLS	CVT	-1.4%	-1.4%	-1.4%	-1.4%	-1.4%	-1.4%
DVVLS	NAUTO	-0.7%	-0.7%	-0.7%	-0.7%	-0.7%	-0.7%
DVVLS	MHEV	-0.8%	-0.8%	-0.8%	-0.8%	-0.8%	-0.8%
DVVLS	BISG	-1.0%	-1.0%	-1.0%	-1.0%	-1.0%	-1.0%
DEACS	6MAN	-0.2%	-0.2%	-0.2%	-0.2%	-0.2%	-0.2%
DEACS	IATC	-0.6%	-0.6%	-0.6%	-0.6%	-0.6%	-0.6%
DEACS	CVT	-1.7%	-1.7%	-1.7%	-1.7%	-1.7%	-1.7%
DEACS	NAUTO	-0.9%	-0.9%	-0.9%	-0.9%	-0.9%	-0.9%
DEACS	MHEV	-0.9%	-0.9%	-0.9%	-0.9%	-0.9%	-0.9%
DEACS	BISG	-1.1%	-1.1%	-1.1%	-1.1%	-1.1%	-1.1%
ICP	6MAN	-0.1%	-0.1%	-0.1%	-0.1%	-0.1%	-0.1%
ICP	IATC	-0.2%	-0.2%	-0.2%	-0.2%	-0.2%	-0.2%
ICP	CVT	-0.8%	-0.8%	-0.8%	-0.8%	-0.8%	-0.8%
ICP	NAUTO	-0.4%	-0.4%	-0.4%	-0.4%	-0.4%	-0.4%
ICP	MHEV	-0.7%	-0.7%	-0.7%	-0.7%	-0.7%	-0.7%
ICP	BISG	-0.9%	-0.9%	-0.9%	-0.9%	-0.9%	-0.9%
DCP	6MAN	-0.1%	-0.1%	-0.1%	-0.1%	-0.1%	-0.1%
DCP	IATC	-0.4%	-0.4%	-0.4%	-0.4%	-0.4%	-0.4%
DCP	CVT	-1.3%	-1.3%	-1.3%	-1.3%	-1.3%	-1.3%
DCP	NAUTO	-0.7%	-0.7%	-0.7%	-0.7%	-0.7%	-0.7%
DCP	MHEV	-0.8%	-0.8%	-0.8%	-0.8%	-0.8%	-0.8%
DCP	BISG	-1.0%	-1.0%	-1.0%	-1.0%	-1.0%	-1.0%
DVVLD	6MAN	-0.2%	-0.2%	-0.2%	-0.2%	-0.2%	-0.2%
DVVLD	IATC	-0.6%	-0.6%	-0.6%	-0.6%	-0.6%	-0.6%
DVVLD	CVT	-1.8%	-1.8%	-1.8%	-1.8%	-1.8%	-1.8%
DVVLD	NAUTO	-1.0%	-1.0%	-1.0%	-1.0%	-1.0%	-1.0%
DVVLD	MHEV	-0.9%	-0.9%	-0.9%	-0.9%	-0.9%	-0.9%
DVVLD	BISG	-1.1%	-1.1%	-1.1%	-1.1%	-1.1%	-1.1%
DEACD	6MAN	-0.2%	-0.2%	-0.2%	-0.2%	-0.2%	-0.2%
DEACD	IATC	-0.6%	-0.6%	-0.6%	-0.6%	-0.6%	-0.6%
DEACD	CVT	-1.8%	-1.8%	-1.8%	-1.8%	-1.8%	-1.8%
DEACD	NAUTO	-1.0%	-1.0%	-1.0%	-1.0%	-1.0%	-1.0%
DEACD	MHEV	-0.9%	-0.9%	-0.9%	-0.9%	-0.9%	-0.9%
DEACD	BISG	-1.1%	-1.1%	-1.1%	-1.1%	-1.1%	-1.1%
CVVL	6MAN	-0.2%	-0.2%	-0.2%	-0.2%	-0.2%	-0.2%
CVVL	IATC	-0.6%	-0.6%	-0.6%	-0.6%	-0.6%	-0.6%
CVVL	CVT	-1.8%	-1.8%	-1.8%	-1.8%	-1.8%	-1.8%
CVVL	NAUTO	-1.0%	-1.0%	-1.0%	-1.0%	-1.0%	-1.0%
CVVL	MHEV	-0.9%	-0.9%	-0.9%	-0.9%	-0.9%	-0.9%
CVVL	BISG	-1.1%	-1.1%	-1.1%	-1.1%	-1.1%	-1.1%
DEACO	6MAN	-0.1%	-0.1%	-0.1%	-0.1%	-0.1%	-0.1%
DEACO	IATC	-0.5%	-0.5%	-0.5%	-0.5%	-0.5%	-0.5%
DEACO	CVT	-1.4%	-1.4%	-1.4%	-1.4%	-1.4%	-1.4%
DEACO	NAUTO	-0.8%	-0.8%	-0.8%	-0.8%	-0.8%	-0.8%
DEACO	MHEV	-0.9%	-0.9%	-0.9%	-0.9%	-0.9%	-0.9%
DEACO	BISG	-1.2%	-1.2%	-1.2%	-1.2%	-1.2%	-1.2%

Table V-12d Synergy pairings and values

Synergies		Fuel Consumption Improvement Synergy values by Vehicle Subclass Positive values are positive synergies, negative values are dissynergies.					
Technology A	Technology B	Large PC	Large Perf. PC	Minivan LT	Small LT	Midsize LT	Large LT
CCPO	6MAN	-0.2%	-0.2%	-0.2%	-0.2%	-0.2%	-0.2%
CCPO	IATC	-0.6%	-0.6%	-0.6%	-0.6%	-0.6%	-0.6%
CCPO	CVT	-1.7%	-1.7%	-1.7%	-1.7%	-1.7%	-1.7%
CCPO	NAUTO	-0.9%	-0.9%	-0.9%	-0.9%	-0.9%	-0.9%
CCPO	MHEV	-1.0%	-1.0%	-1.0%	-1.0%	-1.0%	-1.0%
CCPO	BISG	-1.1%	-1.1%	-1.1%	-1.1%	-1.1%	-1.1%
DVVLO	6MAN	-0.2%	-0.2%	-0.2%	-0.2%	-0.2%	-0.2%
DVVLO	IATC	-0.7%	-0.7%	-0.7%	-0.7%	-0.7%	-0.7%
DVVLO	CVT	-2.0%	-2.0%	-2.0%	-2.0%	-2.0%	-2.0%
DVVLO	NAUTO	-1.1%	-1.1%	-1.1%	-1.1%	-1.1%	-1.1%
DVVLO	MHEV	-1.0%	-1.0%	-1.0%	-1.0%	-1.0%	-1.0%
DVVLO	BISG	-1.1%	-1.1%	-1.1%	-1.1%	-1.1%	-1.1%
CDOHC	6MAN	-0.2%	-0.2%	-0.2%	-0.2%	-0.2%	-0.2%
CDOHC	IATC	-0.7%	-0.7%	-0.7%	-0.7%	-0.7%	-0.7%
CDOHC	CVT	-2.0%	-2.0%	-2.0%	-2.0%	-2.0%	-2.0%
CDOHC	NAUTO	-1.1%	-1.1%	-1.1%	-1.1%	-1.1%	-1.1%
CDOHC	MHEV	-1.0%	-1.0%	-1.0%	-1.0%	-1.0%	-1.0%
CDOHC	BISG	-1.1%	-1.1%	-1.1%	-1.1%	-1.1%	-1.1%
CBRST	6MAN	-0.2%	-0.2%	-0.2%	-0.2%	-0.2%	-0.2%
CBRST	IATC	-0.6%	-0.6%	-0.6%	-0.6%	-0.6%	-0.6%
CBRST	CVT	-1.8%	-1.8%	-1.8%	-1.8%	-1.8%	-1.8%
CBRST	NAUTO	-1.1%	-1.1%	-1.1%	-1.1%	-1.1%	-1.1%
CBRST	BISG	-1.1%	-1.1%	-1.1%	-1.1%	-1.1%	-1.1%
CBRST	EPS	-0.2%	-0.2%	-0.2%	-0.2%	-0.2%	-0.2%
CBRST	IACC	-0.4%	-0.4%	-0.4%	-0.4%	-0.4%	-0.4%
TRBDS	6MAN	-0.2%	-0.2%	-0.2%	-0.2%	-0.2%	-0.2%
TRBDS	IATC	-0.7%	-0.7%	-0.7%	-0.7%	-0.7%	-0.7%
TRBDS	CVT	-2.4%	-2.4%	-2.4%	-2.4%	-2.4%	-2.4%
TRBDS	NAUTO	-1.3%	-1.3%	-1.3%	-1.3%	-1.3%	-1.3%
TRBDS	MHEV	-1.1%	-1.1%	-1.1%	-1.1%	-1.1%	-1.1%
TRBDS	BISG	-1.3%	-1.3%	-1.3%	-1.3%	-1.3%	-1.3%
DSLCL	6MAN	-0.3%	-0.3%	-0.3%	-0.3%	-0.3%	-0.3%
DSLCL	IATC	2.5%	2.5%	2.5%	2.5%	2.5%	2.5%
DSLCL	CVT	-2.9%	-2.9%	-2.9%	-2.9%	-2.9%	-2.9%
DSLCL	NAUTO	-1.7%	-1.7%	-1.7%	-1.7%	-1.7%	-1.7%
DSLCL	MHEV	-1.1%	-1.1%	-1.1%	-1.1%	-1.1%	-1.1%
DSLCL	BISG	-1.1%	-1.1%	-1.1%	-1.1%	-1.1%	-1.1%
DSLTL	6MAN	-0.3%	-0.3%	-0.3%	-0.3%	-0.3%	-0.3%
DSLTL	IATC	2.5%	2.5%	2.5%	2.5%	2.5%	2.5%
DSLTL	CVT	-2.9%	-2.9%	-2.9%	-2.9%	-2.9%	-2.9%
DSLTL	NAUTO	-1.7%	-1.7%	-1.7%	-1.7%	-1.7%	-1.7%
DSLTL	MHEV	-1.1%	-1.1%	-1.1%	-1.1%	-1.1%	-1.1%
DSLTL	BISG	-1.1%	-1.1%	-1.1%	-1.1%	-1.1%	-1.1%
CCPS	CISG	-0.9%	-0.9%	-0.9%	-0.9%	-0.9%	-0.9%
DVVLS	CISG	-1.0%	-1.0%	-1.0%	-1.0%	-1.0%	-1.0%
DEACS	CISG	-1.1%	-1.1%	-1.1%	-1.1%	-1.1%	-1.1%
ICP	CISG	-0.9%	-0.9%	-0.9%	-0.9%	-0.9%	-0.9%
DCP	CISG	-1.0%	-1.0%	-1.0%	-1.0%	-1.0%	-1.0%
DVVLD	CISG	-1.1%	-1.1%	-1.1%	-1.1%	-1.1%	-1.1%
DEACD	CISG	-1.1%	-1.1%	-1.1%	-1.1%	-1.1%	-1.1%
CVVL	CISG	-1.1%	-1.1%	-1.1%	-1.1%	-1.1%	-1.1%
DEACO	CISG	-1.2%	-1.2%	-1.2%	-1.2%	-1.2%	-1.2%
CCPO	CISG	-1.1%	-1.1%	-1.1%	-1.1%	-1.1%	-1.1%
DVVLO	CISG	-1.1%	-1.1%	-1.1%	-1.1%	-1.1%	-1.1%
CDOHC	CISG	-1.1%	-1.1%	-1.1%	-1.1%	-1.1%	-1.1%
CBRST	CISG	-1.1%	-1.1%	-1.1%	-1.1%	-1.1%	-1.1%
TRBDS	CISG	-1.3%	-1.3%	-1.3%	-1.3%	-1.3%	-1.3%
DSLCL	CISG	-1.1%	-1.1%	-1.1%	-1.1%	-1.1%	-1.1%
DSLTL	CISG	-1.1%	-1.1%	-1.1%	-1.1%	-1.1%	-1.1%

9. Refresh and redesign schedule

Because of the complexities of the automobile manufacturing process, manufacturers are generally only able to add new technologies to vehicles on a specific schedule; just because a technology exists in the marketplace, does not mean that it is immediately available for application on all of a manufacturer's vehicles. In the automobile industry there are two terms that describe when technology changes to vehicles occur: redesign and refresh (i.e., freshening). Vehicle redesign usually refers to significant changes to a vehicle's appearance, shape, dimensions, and powertrain. Redesign is traditionally associated with the introduction of "new" vehicles into the market, often characterized as the "next generation" of a vehicle, or a new platform. Vehicle refresh usually refers to less extensive vehicle modifications, such as minor changes to a vehicle's appearance, a moderate upgrade to a powertrain system, or small changes to the vehicle's feature or safety equipment content. Refresh is traditionally associated with mid-cycle cosmetic changes to a vehicle, within its current generation, to make it appear "fresh." Vehicle refresh generally occurs no earlier than two years after a vehicle redesign or at least two years before a scheduled redesign. For the majority of technologies discussed today, manufacturers will only be able to apply them at a refresh or redesign, because their application would be significant enough to involve some level of engineering, testing, and calibration work.⁹⁴

Thus, in addition to developing methods that address limitations on the rates at which new technologies can feasibly penetrate manufacturers' fleets, which NHTSA refers to as phase-in caps, the agency has also developed methods to address the feasible scheduling of changes to specific vehicle models. In the Volpe model, which the agency used to support this proposal, these scheduling-related methods were first applied in 2003, in response to concerns that an early version of the model would sometimes add and then subsequently remove some technologies.⁹⁵ By 2006, these methods were integrated into a new version of the model, one which explicitly "carried forward" technologies added to one vehicle model to succeeding vehicle models in the next model year, and which timed the application of many technologies to coincide with the redesign or freshening of any given vehicle model.⁹⁶ In the 2008 NPRM and subsequent final rule for the MY 2011 CAFE standards, NHTSA tied the application of the majority of technologies to a vehicle's refresh/redesign cycle.

Even within the context of the phase-in caps discussed below, NHTSA considers these model-by-model scheduling constraints necessary in order to produce an analysis that reasonably accounts for the need for a period of stability following the redesign of any given vehicle model. If engineering, tooling, testing, and other redesign-related resources were available for free or at no cost, every vehicle model could be redesigned every year. In reality, however, every vehicle redesign consumes resources simply to address the redesign, and thus cost expenditures occur. Phase-in caps, which are applied at the level of a manufacturer's entire fleet, do not, by themselves, constrain the

⁹⁴ For example, applying material substitution through weight reduction, or even something as simple as low rolling-resistance tires, to a vehicle will likely require some level of validation and testing to ensure that the vehicle may continue to be certified as compliant with NHTSA's Federal Motor Vehicle Safety Standards (FMVSS). Weight reduction might affect a vehicle's crashworthiness; low rolling-resistance tires might change vehicle's braking characteristics or how it performs in crash avoidance tests.

⁹⁵ 68 FR 16874 (Apr. 7, 2003).

⁹⁶ 71 FR 17582 (Apr. 6, 2006).

scheduling of changes to any particular vehicle model. Conversely, scheduling constraints to address vehicle freshening and redesign do not necessarily yield realistic overall penetration rates for a particular technology type (e.g., for strong hybrids), while phase-in caps do. Thus, the two constraints work together in the model to ensure that the timing and application rate for various fuel-saving technologies is feasible for manufacturers on a year-by-year basis, as required by EPCA/EISA.⁹⁷

For purposes of the analysis supporting this proposal, NHTSA has employed, as inputs to the Volpe model, a redesign cycle of 5 years for all manufacturers, with a refresh cycle of 2-3 years. This is the schedule employed in the analysis that supported the MY 2011 final rule, and is consistent with the most recent manufacturer product plans received in response to NHTSA's March 2009 request for updated plans. However, the application of the refresh/redesign cycle in the modeling analysis has changed in this proposal from the MY 2011 final rule due to the characteristics of the new joint approach for establishing the baseline fleet. The paragraphs below explain how NHTSA developed the refresh/redesign cycle, and how its application has changed for this proposal.

In the MY 2011 final rule NHTSA developed the redesign and refresh schedules based on a combination of manufacturers' confidential product plans and NHTSA's engineering judgment. In most instances, NHTSA reviewed manufacturers' planned redesign and refresh schedules as stated in their confidential submissions and incorporated them into the market data file, as done in past rulemakings. If companies did not provide product plan data, NHTSA used publicly available data to estimate the redesign and refresh schedules for the vehicles produced by these companies.⁹⁸ Unless a manufacturer submitted plans for a more rapid redesign and refresh schedule, NHTSA assumed that passenger cars would normally be redesigned every 5 years, consistent with industry trends over the last 10-15 years.⁹⁹ NHTSA also projected a 5-year redesign cycle for the majority of light trucks.¹⁰⁰ A fuller discussion of NHTSA's justification and rationale for the 5-year redesign cycle can be found in the MY 2011 final rule.¹⁰¹

Some manufacturers commented in the last round of CAFE rulemaking, even before the economic crisis had reached today's levels, that their vehicle redesign cycles take at least five years for cars and 6 years and longer for trucks because they rely on those later years to recover investments and earn a profit. They argued that they would not be able to sustain their businesses if forced by CAFE standards to a shorter redesign cycle. Expecting that those concerns may be magnified in the current economic climate,

⁹⁷ 49 U.S.C. § 32902(a) requires that NHTSA set CAFE standards at the maximum feasible level for each fleet, for each model year.

⁹⁸ Sources included but were not limited to manufacturers' web sites, industry trade publications (e.g., Automotive News), and commercial data sources (e.g., Wards Automotive, etc.).

⁹⁹ Exceptions were made for high performance vehicles and other vehicles that traditionally had longer than average design cycles due to their unique design characteristics and their evolutionary, as opposed to revolutionary product development practices (e.g., the Porsche 911 has remained the same basic vehicle for many years).

¹⁰⁰ NHTSA recognized in the MY 2011 CAFE rulemaking that light trucks are currently redesigned every 5 to 7 years, with some vehicles (like full-size vans) having longer redesign periods. However, in the most competitive SUV and crossover vehicle segments, the redesign cycle currently averages slightly above 5 years. NHTSA concluded that the light truck redesign schedule will be shortened in the future due to competitive market forces. Thus, for almost all light trucks scheduled for a redesign in the early portions of the rulemaking period, NHTSA projected a 5-year redesign cycle.

¹⁰¹ 74 FR 14265 (Mar. 30, 2009)

NHTSA recognizes that some manufacturers are severely stressed and may be hoping to delay planned vehicle redesigns in order to conserve financial resources. However, manufacturers must balance this concern against their interest in continuing to provide vehicles that the public wishes to purchase, which may be redesigned or refreshed vehicles.

Consistent with its forecast of the overall size of the light vehicle market from MY 2011 on, the agency tentatively expects that the industry's status will improve and that manufacturers will typically redesign both car and truck models every 5 years in order to be competitive in the market. Thus, the agency is retaining the 5-year redesign with 2-3 year refresh cycle assumptions for the current proposal, noting that, for the most part, the cycle times are supported by manufacturer's confidential responses to NHTSA's March 2009 product plan request. However, we will continue to monitor industry trends and will reassess these assumptions for the final rule, and we invite comment on these assumptions.

With regard to how the refresh/redesign cycle was implemented in the modeling analysis for this proposal given the new joint baseline approach, as discussed above in [TSD Ch.1], NHTSA previously used confidential manufacturer product plan information and the refresh and redesign dates contained therein for formulating the market data input file used by the Volpe model, or relied on other sources of information where that data did not exist. For purposes of this joint proposal, in contrast, the agencies developed a baseline vehicle fleet data file from MY 2008 CAFE certification data. As discussed above, the certification data represents an historical data source that is publicly available, which allows NHTSA to make the baseline market data file itself publicly available. The advantage to this approach is the greater transparency provided with a publicly-available baseline market data file as compared to one based on confidential manufacturer data, as also discussed at greater length above.

However, using adjusted historical data rather than estimated future data impacts how NHTSA is able to model the refresh/redesign cycle in its analysis of year-by-year maximum feasible CAFE standards. For example, some vehicles that exist in the MY 2008 certification-data based fleet manufacturers have indicated (either publicly or in their product plans) they will be discontinued (*i.e.*, no longer produced or sold) prior to or within the rulemaking period. Conversely, some vehicle models will be first introduced to the market during the rulemaking time frame, like GM's Chevy Volt and Chrysler's anticipated new models based on Fiat platforms. Since these vehicles were not sold (unavailable) in 2008, they do not exist in the MY 2008 certification data, and thus do not exist in the proposal's market data file.

To address this problem, NHTSA first determined redesign schedules for the baseline MY 2008 vehicles, using publicly-available data and its own engineering judgment, which required finding the date of most recent redesign for each vehicle. Next, the agency applied 5-year redesign cycles to obtain new redesign dates for each vehicle, starting with the date of most recent redesign and working forward. Thus, a vehicle that was determined to have been last redesigned in MY 2008 would be projected to be redesigned again in MY 2013. The assumption here is that future vehicles that are replacements for vehicles currently in the market will tend to follow the same cycles as their predecessors, so it is appropriate to reflect the MY 2013 date in the market data file. NHTSA tried to ensure that most if not all vehicles had a redesign scheduled in the

analysis during the rulemaking time frame, consistent with the industry's response in confidential product plans to the estimated levels of stringency announced in the joint NOI preceding these proposed standards. Manufacturers appear to be redesigning the vast majority of today's vehicles, or replacing them with new models, between now and the end of MY 2016. Finally, the agency determined refresh dates in a similar fashion, based on those of the baseline fleet and using the 2 to 3 year cycle, also working to ensure that all vehicles underwent a refresh cycle within the rulemaking time frame.

In previous rulemakings, NHTSA used manufacturers' confidential information to establish entries in the market file for each unique vehicle model, including new models (such as the GM Volt) when they were introduced. For the new approach, which does not rely on confidential manufacturer information to produce the baseline vehicle fleet and which does not model all of the specific vehicles that manufacturers currently intend to produce during the rulemaking time frame, the agency had to develop a new method for accounting for the addition and subtraction of vehicles during that time frame from the pool of vehicles that makes up the MY 2008 baseline fleet.

NHTSA accounts for these changes in the vehicle fleet as follows. While each entry in the new baseline market data file, by definition, is a vehicle that was sold in MY 2008 (based on the MY 2008 certification data), for purposes of projecting that vehicle model forward into the future fleet in the rulemaking period, each entry can also be used to represent a vehicle in that particular market segment (e.g., subcompact, SUV/CUV, pickup, etc.) of a manufacturer's future fleet. The particular vehicle model shown in the file may or may not be sold in the future vehicle fleet, and in fact some models are expected to be discontinued well before MY 2016, as discussed above.

However, NHTSA believes that it is reasonable to expect that the manufacturer will produce a similar vehicle, or some group of similar vehicles, to compete in the same market segment—whether the manufacturer will offer the same vehicle model, a fully redesigned but otherwise similar version of that model, or an entirely new vehicle or group of vehicles, sold as a new model or nameplate of a similar type. This is how NHTSA addresses the issue of the GM Volt: although it does not appear in the baseline market data file, it will be considered as one of the existing GM models of similar type and in the same market segment once it becomes available. NHTSA also used manufacturers' product plans as a check on this approach, and found them fairly consistent with the resulting baseline market data file.

The baseline market data file, available on NHTSA's website, contains the refresh and redesign dates developed by NHTSA for this proposal, and the public can review them there. Readers are invited to provide comment on the cycle dates established, the method used for determining them, and the use of non-confidential data in deriving them, including any suggestions for improvement. The table below provides whether particular technologies are "anytime" technologies, "redesign only" technologies, or "refresh or redesign" technologies, for purposes of this proposal.

Table V-13 Technology Refresh and Redesign Application

Technology	Redesign only	Redesign or Refresh	Anytime
Low Friction Lubricants			X
Engine Friction Reduction		X	
VVT - Coupled Cam Phasing (CCP) on SOHC		X	
Discrete Variable Valve Lift (DVVL) on SOHC	X		
Cylinder Deactivation on SOHC		X	
VVT - Intake Cam Phasing (ICP)		X	
VVT – Dual Cam Phasing (DCP)		X	
Discrete Variable Valve Lift (DVVL) on DOHC	X		
Continuously Variable Valve Lift (CVVL)	X		
Cylinder Deactivation on DOHC		X	
Cylinder Deactivation on OHV		X	
VVT - Coupled Cam Phasing (CCP) on OHV		X	
Discrete Variable Valve Lift (DVVL) on OHV	X		
Conversion to DOHC with DCP	X		
Stoichiometric Gasoline Direct Injection (GDI)	X		
Combustion Restart		X	
Turbocharging and Downsizing	X		
Exhaust Gas Recirculation (EGR) Boost	X		
Conversion to Diesel following CBRST	X		
Conversion to Diesel following TRBDS	X		
6-Speed Manual/Improved Internals	X		
Improved Auto. Trans. Controls/Externals		X	
Continuously Variable Transmission	X		
6/7/8-Speed Auto. Trans with Improved Internals	X		
Dual Clutch or Automated Manual Transmission	X		
Electric Power Steering		X	
Improved Accessories		X	
12V Micro-Hybrid	X		
Belt Integrated Starter Generator	X		
Crank Integrated Starter Generator	X		
Power Split Hybrid	X		
2-Mode Hybrid	X		
Plug-in Hybrid	X		
Mass Reduction 1 (1.5%)		X	
Mass Reduction 2 (3.5% – 8.5%)	X		
Low Rolling Resistance Tires		X	
Low Drag Brakes		X	
Secondary Axle Disconnect 4WD		X	
Aero Drag Reduction		X	

10. Phase-in caps

Besides the refresh/redesign cycles used in the Volpe model, which constrain the rate of technology application at the vehicle level so as to ensure a period of stability following any modeled technology applications, the other constraint on technology application employed in NHTSA’s analysis is “phase-in caps.” Unlike vehicle-level

cycle settings, phase-in caps constrain technology application at the vehicle manufacturer level.¹⁰² They are intended to reflect a manufacturer's overall resource capacity available for implementing new technologies (such as engineering and development personnel and financial resources) thereby ensuring that resource capacity is accounted for in the modeling process. At a high level, phase-in caps and refresh/redesign cycles work in conjunction with one another to avoid the modeling process out-pacing an OEM's limited pool of available resources during the rulemaking time frame, especially in years where many models may be scheduled for refresh or redesign. This helps to ensure technological feasibility and economic practicability in determining the stringency of the standards.

NHTSA has been developing the concept of phase-in caps over the course of the last several CAFE rulemakings, as discussed in greater detail in the MY 2011 final rule.¹⁰³ In 2002, when NHTSA proposed MY 2005-2007 standards for light trucks using a predecessor modeling algorithm to the Volpe model, manufacturers commented extensively on the issue of lead time and the potential for the rapid and widespread application of new technologies in the agency's analysis. Specifically, GM's comment pointed to the most significant manufacturer concern, the algorithm's "application of technologies to all truck lines in a single model year."¹⁰⁴ In response, NHTSA modified the algorithm to moderate the rates at which technologies were estimated to penetrate manufacturers' fleets in the MY 2005-2007 CAFE standards. The modeling changes produced more realistic estimates of the technologies manufacturers could apply in response to new standards, and more realistic estimates of the costs of those standards.

Explicit phase-in caps were included in the Volpe model analysis for the next rulemaking, establishing standards for MY 2008-2011 light trucks. These phase-in caps constrained the rates at which each technology would be estimated to penetrate each manufacturer's fleet in response to new CAFE standards. The agency's final standards for those model years used phase-in caps of up to 25 percent (corresponding to full penetration of the fleet within 4 years) for most technologies, and up to 10 percent (full penetration of the fleet within 10 years) for more advanced technologies such as hybrid electric vehicles.¹⁰⁵ The agency based these rates on consideration of comments and on the 2002 NAS Committee's findings that "widespread penetration of even existing technologies will probably require 4 to 8 years" and that for emerging technologies "that require additional research and development, this time lag can be considerably longer."¹⁰⁶

In its 2008 NPRM proposing new CAFE standards for passenger cars and light trucks sold during MYs 2011-2015, NHTSA considered manufacturers' planned product

¹⁰² While phase-in caps are expressed as specific percentages of a manufacturer's fleet to which a technology may be applied in a given model year, phase-in caps cannot always be applied as precise limits, and the Volpe model in fact allows "override" of a cap in certain circumstances. When only a small portion of a phase-in cap limit remains, or when the cap is set to a very low value, or when a manufacturer has a very limited product line, the cap might prevent the technology from being applied at all since any application would cause the cap to be exceeded. Therefore, the Volpe model evaluates and enforces each phase-in cap constraint after it has been exceeded by the application of the technology (as opposed to evaluating it before application), which can result in the described overriding of the cap.

¹⁰³ 74 FR 14268-14271 (Mar. 30, 2009)

¹⁰⁴ 68 FR 16874 (Apr. 7, 2003).

¹⁰⁵ 71 FR 17572, 17679 (Apr. 6, 2006).

¹⁰⁶ *Id.* at. 17572. *See also* 2002 NAS Report, at 5.

offerings and estimates of technology availability, cost, and effectiveness, as well as broader market conditions and technology developments. The agency concluded that many technologies could be deployed more rapidly than it had estimated during the prior rulemaking¹⁰⁷ and increased some of the estimates as it determined appropriate. However, as in its earlier CAFE rulemakings, the agency continued to recognize that myriad constraints prohibit most technologies from being applied across an entire fleet of vehicles within a single year, even if those technologies are readily available in the market.

The comments NHTSA received in response to the 2008 proposal asserted three basic concerns with the agency's adjustments to phase in caps; a) that the hybrid phase-in caps were much lower than manufacturer announcements would otherwise suggest, b) that the phase-ins were too high in the early years of the rulemaking and did not reflect the very small (from a manufacturing perspective) amount of lead-time between the final rule and the standards taking effect, and/or were too low in the later years of the rulemaking given the increased lead-time, or c) that NHTSA did not consider the resources (either in terms of capital or engineering) required to implement the number (quantities) of technologies implied by the phase-in caps simultaneously.

NHTSA responded to these comments in the final rule,¹⁰⁸ noting that a number of factors potentially impact a manufacturer's ability to implement new technologies, including commercial viability, infrastructure requirements, and resource and lead-time considerations.¹⁰⁹ The agency explained that evaluating all the factors involved would require an extraordinary effort and that the analysis would likely involve significant uncertainties that would raise questions about its accuracy and usefulness. Nevertheless, the agency concluded that its use of phase-in caps was still appropriate "to apply the agency's best judgment of the extent to which such factors combine to constrain the rates at which technologies may feasibly be deployed." NHTSA emphasized that the MY 2011 phase-in caps were based on assumptions for the full five year period of the proposal (2011-2015), and stated that it would reconsider the phase-in settings for all years beyond 2011 in future rulemaking analysis. Some phase-in caps for individual technologies were raised and some were lowered, and the Volpe model was revised to add the ability to define unique phase-in caps for each model year, allowing non-linear technology application rates throughout the rulemaking period (lower in the early years and increased in later, or vice-versa) if required.

For purposes of the current proposal for MYs 2012-2016, Table XX-8 below outlines the phase-in caps for the technologies used in this proposal by model year. As in the MY 2011 final rule, NHTSA combines phase-ins caps for some groups of similar technologies, such as valve phasing technologies that are applicable to different forms of engine design (SOHC, DOHC, OHV), since they are very similar from an engineering and implementation standpoint. When the phase-in caps for two technologies are combined, the maximum total application of either or both to any manufacturers' vehicle fleet is limited to the value of the cap.¹¹⁰ In contrast to the phase-in caps used in the MY

¹⁰⁷ 73 FR 24387-88 (May 2, 2008).

¹⁰⁸ 74 FR 14268-69 (Mar 30, 2009)

¹⁰⁹ 74 FR 14268 (Mar. 30, 2009)

¹¹⁰ See 74 FR 14270 (Mar 30, 2009) for further discussion and examples.

2011 final rule, NHTSA has increased the phase-in caps for most of the technologies, except those for diesels and stronger hybrid technologies, as discussed below.

In developing phase-in cap values for purposes of the current proposal, NHTSA initially considered the fact that many of the technologies commonly applied by the model, those placed near the top of the decision trees, such as low friction lubes, valve phasing, electric power steering, improved automatic transmission controls, and others, have been commonly available to manufacturers for several years now. Many technologies, in fact, precede the 2002 NAS Report, which estimated that such technologies would take 4 to 8 years to penetrate the fleet. Since the current proposal would take effect in MY 2012, nearly 10 years beyond the NAS report, and extends to MY 2016, NHTSA determined that higher phase-in caps were likely justified. Additionally, NHTSA considered the fact that manufacturers, as part of the agreements supporting the National Program, appear to be anticipating higher technology application rates than those used in the MY 2011 final rule. This also supported higher phase-in caps of commonly applied technologies for purposes of the proposal.

However, for a few of the more complex and intrusive (from an implementation perspective) technologies, specifically dieselization and stronger hybridization, NHTSA has retained the more stringent phase-in levels used in the 2011 final rule since these technologies represent, for the most part, a significant departure from the vehicle architectures commonly utilized by most OEMs today. As was the case in the 2011 rule, these more stringent phase-in caps limit technology application, i.e., due to the Volpe modeling process, to 3 percent per annum up to a maximum of 15 percent by the 2016 model year.¹¹¹ Additionally, for some technologies that are not available in certain model years, a phase-in cap of 0 percent is shown for those model years, such as one of the mass reduction technologies that is not determine to be available until 2014; hence the values of 0 percent for MYs 2012 and 2013 shown in Table V-14 below.

Theoretically, significantly higher phase-in caps, such as those used in the current proposal as compared to those used in the MY 2011 final rule, should result in higher levels of technology penetration in the modeling results. Reviewing the modeling output does not, however, indicate unreasonable levels of technology penetration as shown in Tables V-45 and V-46. NHTSA believes that this is due to the interaction of the various changes in methodology for the current proposal--changes to phase-in caps are but one of a number of revisions to the Volpe model and its inputs that could potentially impact the rate at which technologies are applied in this proposal as compared to prior rulemakings. Other revisions that could impact application rates include the use of transparent CAFE certification data in baseline fleet formulation and the use of other data for projecting it forward,¹¹² or the use of a multi-year planning programming technique to apply technology retroactively to earlier-MY vehicles, both of which may have a direct impact on the modeling process. Conversely the model and inputs remain unchanged in other areas that also could impact technology application, such as in the refresh/redesign cycle

¹¹¹ A 15 percent maximum application rate should not be confused with the overall penetration of the technology, i.e., the amount of the technology applied by the modeling process plus that which existed in the baseline or was installed at the discretion of the manufacturer. Penetration rates typically exceed application rates.

¹¹² The baseline fleet sets the starting point, from a technology point of view, for where the model begins the technology application process, so changes have a direct impact on the net application of technology.

settings, or the effectiveness estimates used for the technologies, both of which remain largely unchanged from the MY 2011 final rule. These changes together make it difficult to predict how phase-in caps should be expected to function in the new modeling process.

Thus, after reviewing the output files, NHTSA believes that the higher phase-in caps, and the resulting technology application rates produced by the Volpe model, at both the industry and manufacturer level, are appropriate for this proposal, achieving a suitable level of stringency without requiring unrealistic or unachievable penetration rates.

However, the agency will consider comments received on this approach in determining what phase-in caps to employ in the analysis for the final rule, and may change the caps in response to comments and/or further analysis. One additional question the agency has, which may be primarily academic at this point, is what impact lower phase-in caps, such as those used in earlier rulemakings, would have on compliance costs (and whether they might counter-intuitively increase costs by forcing more expensive technologies).

Readers are invited to review and assess the phase-in caps in Table V-14, along with the application and penetration rates found in the Volpe model's output files, and after making their own assessment, provide comment and recommendations to the agency as appropriate.

Table V-14 Phase in caps from 2006 rule, 2008 NPRM, and current rule

<i>Technology</i>	<i>Final Rule</i>	<i>NPRM Phase-In Caps by Model Year *</i>				
	<i>MY 2011</i>	<i>2012</i>	<i>2013</i>	<i>2014</i>	<i>2015</i>	<i>2016</i>
Low Friction Lubricants	50%	100%	100%	100%	100%	100%
Engine Friction Reduction	20%	85%	85%	85%	100%	100%
VVT - Coupled Cam Phasing (CCP) on SOHC	15%	85%	85%	85%	100%	100%
Discrete Variable Valve Lift (DVVL) on SOHC	15%	85%	85%	85%	100%	100%
Cylinder Deactivation on SOHC	9%	85%	85%	85%	85%	85%
VVT - Intake Cam Phasing (ICP)	15%	85%	85%	85%	100%	100%
VVT – Dual Cam Phasing (DCP)	15%	85%	85%	85%	100%	100%
Discrete Variable Valve Lift (DVVL) on DOHC	15%	85%	85%	85%	100%	100%
Continuously Variable Valve Lift (CVVL)	15%	85%	85%	85%	100%	100%
Cylinder Deactivation on DOHC	9%	85%	85%	85%	85%	85%
Cylinder Deactivation on OHV	9%	85%	85%	85%	85%	85%
VVT - Coupled Cam Phasing (CCP) on OHV	15%	85%	85%	85%	100%	100%
Discrete Variable Valve Lift (DVVL) on OHV	15%	85%	85%	85%	100%	100%
Conversion to DOHC with DCP	9%	85%	85%	85%	85%	85%
Stoichiometric Gasoline Direct Injection (GDI)	3%	85%	85%	85%	85%	85%
Combustion Restart	0%	0%	0%	85%	85%	85%
Turbocharging and Downsizing	9%	85%	85%	85%	85%	85%
Exhaust Gas Recirculation (EGR) Boost	0%	0%	85%	85%	85%	85%
Conversion to Diesel following CBRST	3%	3%	6%	9%	12%	15%
Conversion to Diesel following TRBDS	3%	3%	6%	9%	12%	15%
6-Speed Manual/Improved Internals	33%	85%	85%	85%	100%	100%
Improved Auto. Trans. Controls/Externals	33%	85%	85%	85%	100%	100%
Continuously Variable Transmission	5%	85%	85%	85%	85%	85%
6/7/8-Speed Auto. Trans with Improved Internals	50%	85%	100%	100%	100%	100%
Dual Clutch or Automated Manual Transmission	20%	85%	100%	100%	100%	100%
Electric Power Steering	10%	85%	85%	85%	100%	100%
Improved Accessories	10%	85%	85%	85%	100%	100%
12V Micro-Hybrid	3%	85%	85%	85%	85%	85%
Belt mounted Integrated Starter Generator	n/a	85%	85%	85%	85%	85%
Crank mounted Integrated Starter Generator	n/a	3%	6%	9%	12%	15%
Power Split Hybrid	0%	3%	6%	9%	12%	15%
2-Mode Hybrid	0%	3%	6%	9%	12%	15%
Plug-in Hybrid	0%	3%	6%	9%	12%	15%
Mass Reduction (1.50%)	5%	85%	85%	85%	85%	100%
Mass Reduction (5% to 10% Cum)	5%	85%	85%	85%	85%	100%
Low Rolling Resistance Tires	20%	85%	85%	85%	100%	100%
Low Drag Brakes	20%	85%	85%	85%	100%	100%
Secondary Axle Disconnect - Ladder Frame	17%	85%	85%	85%	100%	100%
Aero Drag Reduction	17%	85%	85%	85%	100%	100%

* - a phase-in cap of 0% is shown for the years the technology is unavailable

D. Specific technologies considered for application and NHTSA's estimates of their incremental costs and effectiveness

1. What data sources did NHTSA evaluate?

NHTSA and EPA have done extensive research in identifying the most credible sources of information. These sources included: the 2002 NAS report on the effectiveness and impact of CAFE standards;¹¹³ the 2004 study done by NESCCAF;¹¹⁴ the California Air Resources Board (CARB) Initial Statement of Reasons in support of their carbon

¹¹³ "Effectiveness and Impact of Corporate Average Fuel Economy (CAFE) Standards," National Research Council, National Academy of Sciences, 2002.

¹¹⁴ "Reducing Greenhouse Gas Emissions from Light-Duty Motor Vehicles," Northeast States Center for a Clean Air Future, September 2004.

rulemaking;¹¹⁵ a 2006 study done by Energy and Environmental Analysis (EEA) for the Department of Energy;¹¹⁶ a study done by the Martec Group for the Alliance of Automobile Manufacturers, and an update by the Martec Group to that study;¹¹⁷ and vehicle fuel economy certification data. Both agencies also reviewed the published technical literature which addressed the issue of CO₂ emission control and fuel economy, such as papers published by the Society of Automotive Engineers and the American Society of Mechanical Engineers. In addition, confidential data submitted by vehicle manufacturers in response to NHTSA's request for product plans,¹¹⁸ and confidential information shared by automotive industry component suppliers in meetings with EPA and NHTSA staff held during the second half of the 2007 calendar year were used as a cross check of the public data mentioned above and not as a significant basis for this rulemaking. EPA also has a contracted study ongoing with FEV that consists of complete system tear-downs to evaluate technologies down to the nuts and bolts to arrive at very detailed estimates of the costs associated with manufacturing them (and, as noted, the agencies used this analysis to estimate costs of turbocharging with downsizing).¹¹⁹ EPA and NHTSA reviewed all this information in order to develop the best estimates of availability, cost and effectiveness of these fuel-saving/CO₂-reducing technologies.

The agencies would also like to note that per the Energy Independence and Security Act (EISA), the National Academies of Sciences is conducting an updated study to update chapter 3 of their 2002 NAS Report, which presents technology effectiveness estimates. The update will take a fresh look at that list of technologies and their associated cost and effectiveness values.

Some of specific tasks that NAS will undertake in updating the technology chapter are to define and document specific methodologies and input parameters to account for the sequential application and incremental benefits and costs of technologies, including the methods used to account for variations in vehicle characteristics (*e.g.*, size, weight, engine characteristics). Some methodologies might involve simple mathematical relationships (*e.g.*, cost per cylinder). Others might involve matrices (*e.g.*, of effectiveness versus vehicle category or versus the presence of other technologies) or more complex structural representations (*e.g.*, decision trees). In addition, NAS will identify and assess leading computer models for projecting vehicle fuel economy as a function of additional technology. These models would include both lumped-parameter (or Partial Discrete Approximation) type models, where interactions between technologies are represented using energy partitioning and/or scalar adjustment factors (aka "synergy" factors), and full vehicle simulation, in which such interactions are analyzed using explicit drive cycle and engine cycle simulation, based on detailed vehicle

¹¹⁵ "Staff Report: Initial Statement of Reasons for Proposed Rulemaking," California Environmental Protection Agency, Air Resources Board, Regulations to Control Greenhouse Gas Emissions from Motor Vehicles, August 6, 2004.

¹¹⁶ "Technology to Improve the Fuel Economy of Light Duty Trucks to 2015," Energy and Environmental Analysis, Inc., May 2006.

¹¹⁷ "Variable Costs of Fuel Economy Technologies," prepared for The Alliance of Automobile Manufacturers, June 1, 2008; and, "Variable Costs of Fuel Economy Technologies," prepared for The Alliance of Automobile Manufacturers, June 1, 2008, Amended December 10, 2008.

¹¹⁸ 74 FR 9185 (Mar. 3, 2009)

¹¹⁹ "Draft Report – Light-Duty Technology Cost Analysis Pilot Study," U.S. Environmental Protection Agency, Contract No. EP-C-07-069, Work Assignment 1-3, September 3, 2009

engineering characteristics (*e.g.*, including engine maps, transmission shift points, etc.). Finally, NAS will examine the effectiveness and impacts of vehicle weight and engine size/horsepower reductions which will be limited to advances in structural design and lightweight materials.

The updated NAS report is expected to be available on September 30, 2009. As the Report is received by the agencies, it will be placed in the respective dockets for this rulemaking for the public's review and comment. Because this is expected to occur during the comment period, the public is encouraged to check the docket regularly and provide comments on the updated NAS Report by the closing of the public comment period. As requested by the President in the January 26, 2009 Executive Order, NHTSA and EPA will consider the updated NAS Report and any comments received on it, as appropriate, in developing the technology cost and effectiveness estimates for the final rule.

The Indirect Cost Methodology (ICM)

Indirect costs include production-related costs (research, development, and other engineering), business-related costs (corporate salaries, pensions), and retail-sales-related costs (dealer support, marketing). For this analysis, direct cost estimates were first developed for each technology or system at the auto manufacturer level, *i.e.*, the price paid by the manufacturer to a Tier 1 component supplier. To these costs, an indirect cost markup factor was then applied that varied by the best estimate of the particular technology's complexity. This section describes the approach to determining the indirect cost multipliers (ICM) used in this analysis and the specific multipliers used for each piece of technology.

Concept behind and development of indirect cost multipliers

If all desirable data were available, when a new technology is implemented, the costs of that technology would include the direct and indirect costs particular to that technology. For instance, some changes may involve new tooling, while others may not; some may affect the way the car is marketed, while others are of limited interest to consumers. In a world of full information, the indirect costs of a new technology would be calculated specifically for that technology. In practice, though, it is often difficult, if not impossible, to identify the indirect costs specific to a new technology.

The automotive industry, EPA, and NHTSA have commonly used retail price equivalent (RPE) multipliers to approximate the indirect costs associated with a new technology. The RPE is a ratio of total revenues to direct manufacturing costs. Because, by definition, total revenues = direct costs + indirect costs + profit, the RPE is the factor that, when multiplied by direct manufacturing costs, recovers total revenue. This multiplication is accurate only in the aggregate; it does not in reality apply to any specific technology. The RPE is a way to estimate indirect costs on the assumption that indirect costs are constant across all technologies and processes in a company. In the MY 2011 CAFE final rule NHTSA utilized a 1.5 RPE multiplier.

In fact, however, the indirect costs of new technologies vary, both with the complexity of the technology and with the time frame. For instance, a hybrid-electric engine is likely to involve greater research and development and marketing costs per dollar of direct costs than low-rolling-resistance tires; the research and development costs of any technology are likely to decrease over time. In recognition of this concern, EPA contracted with RTI International to provide a current estimate of the RPE multiplier and to examine whether the indirect costs of new technologies are likely to vary across technologies. The report “Automobile Industry Retail Price Equivalent and Indirect Cost Multipliers,” by Alex Rogozhin, Michael Gallaher, and Walter McManus,¹²⁰ calculates the RPE multiplier as 1.46 in 2007. The report then develops indirect cost (IC) multipliers that vary with the complexity of technology and the time frame. While any multiplier is only an approximation of the true indirect costs of a new technology, the IC multipliers in this report move away from the assumption that the proportion of indirect costs is constant across all technologies and take into account some of the variation in these costs. The multipliers developed in this report are presented in Table V-15.

The indirect cost multipliers used adjustment factors, developed by a team of EPA engineers with expertise in the auto industry, which accounted for the differences in complexity of the specific technologies under study. To examine the sensitivity of the results to different technologies of the same complexity, and to provide more detailed documentation of the development of the adjustment factors, EPA convened a second panel,¹²¹ with NHTSA’s input, to develop adjustment factors for three different technologies. This latter process allowed for estimates of the variation in adjustment factors, and thus in the variation of indirect cost multipliers. These results are also presented in Table V-15.

¹²⁰ Rogozhin, Alex, Michael Gallaher, and Walter McManus, “Automobile Industry Retail Price Equivalent and Indirect Cost Multipliers,” EPA 420-R-09-003, February 2009, <http://epa.gov/otaq/ld-hwy/420r09003.pdf>.

¹²¹ “Memorandum: Documentation of the Development of Indirect Cost Multipliers for Three Automotive Technologies,” Gloria Helfand and Todd Sherwood, Office of Transportation and Air Quality, U.S. Environmental Protection Agency

Table V-15
Indirect Cost Multipliers

STUDY	TECHNOLOGY COMPLEXITY							
	Short Run			Long Run				
	Low	Medium	High	Low	Medium	High		
RTI Report	1.05	1.20	1.45	1.02	1.05	1.26		
EPA Memo: Average	1.16	1.29	1.64	1.12	1.20	1.39		
Standard Deviation	0.14	0.15	0.21	0.14	0.13	0.15		
Median	1.12	1.26	1.66	1.06	1.20	1.40		
Max	1.43	1.53	2.15	1.42	1.45	1.69		
Min	1.00	1.02	1.37	1.00	1.01	1.12		
Multipliers Used in this Analysis	1.11	1.25	1.45	1.64	1.07	1.13	1.26	1.39

The table shows minor differences in the multipliers for low- and medium-complexity technologies (roughly 0.1), but larger differences in the high-complexity technologies. The EPA and NHTSA engineers who reviewed the results believed that the differences reflected actual differences in the technologies under study. In particular, for low complexity, low-rolling-resistance tires (the application in the RTI Report) would involve lower indirect costs than aerodynamic improvements (the application in the EPA memo); and, for medium complexity, dual-clutch transmissions (the application in the RTI Report) should have a smaller multiplier than engine downsizing done in conjunction with turbocharging (the application in the EPA Memo). For these two cases, EPA and NHTSA considered these technologies to span the range of technologies assigned to those classes; the costs in this study, then, use the averages of the values of the two reports, as shown in the last line of Table V-15. For high complexity technologies, the agencies felt the technologies assigned to these categories—hybrid-electric vehicles in the RTI Report; plug-in hybrid electric vehicles in the EPA Memo—were sufficiently different that each deserved a different category. This is discussed in more detail in the next section which highlights the multipliers used for each specific technology.

Application of specific indirect cost multipliers to each technology

As noted in the previous section, a different ICM was applied to each technology's direct cost to arrive at its compliance cost. These different ICMs were chosen based on the complexity of the technology in the opinions of staff engineers at EPA and NHTSA, most of whom have several years of experience in the auto industry. As shown in Table V-15, ICMs were developed via two separate processes: that presented in the RTI report; and that presented in the EPA Memo. While all of the ICMs generated via these two processes were in general agreement, some differences did exist. In determining how to deal with these differences, EPA and NHTSA agreed that, for the low and medium complexity technologies, a simple average of the two values would be used. However, for the high complexity technologies, it was decided that two separate

high-multipliers should be used. The lower multiplier, deemed high, would be applied to those technologies of high complexity but with some level of use in the marketplace today. Such technologies would be power-split and 2-mode hybrid electric vehicles. The higher multiplier, deemed high+, would be applied to those technologies of high complexity but with no, or essentially no, use in the current fleet. Such technologies would be plug-in hybrids and full electric vehicles. Table V-16 shows the complexity level for each technology considered in this analysis.

Table V-16 Complexity Levels of Technologies

LOW COMPLEXITY	MEDIUM COMPLEXITY	HIGH COMPLEXITY	HIGH+ COMPLEXITY
Low friction lubes (LUB)	Combustion Restart (CBRST)	Continuously variable valve lift (CVVL)	Plug-in hybrid
Engine friction reduction (EFR)	Exhaust gas recirculation boost (EGRB)	2-mode hybrid (2MHEV)	Full electric vehicle
Intake cam phasing (ICP)	Belt integrated starter generator (BISG)	Power-split hybrid (PSHEV)	
Coupled cam phasing (CCPO) and (CCPS)	Turbocharge with downsize (TRBDS)	Crankshaft integrated starter generator (CISG)	
Dual cam phasing (DCP)	Conversion to diesel (DSL) and (DSL2)		
Cylinder deactivation (DEACS), (DEACD), and (DEACO)	Dual clutch transmission (DCTAM)		
Discrete variable valve lift (DVVLS), (DVVLO) and (DVVLD)	Continuously variable transmission (CVT)		
Stoichiometric gasoline direct injection (SGDI)	12 volt micro hybrid (MHEV)		
Conversion to DOHC with DCP (CDOHC)			
6/7/8-speed auto transmission (NAUTO)			
Improved auto transmission (IATC)			
6-speed manual transmission (6MAN)			
Improved accessories (IACC)			
Electric power steering (EPS)			
Low rolling resistance tires (ROLL)			
Low drag brakes (LDB)			
Secondary axle disconnect (SAXU/SAXL)			
Improved aerodynamics (AERO)			
Mass reduction (MS1) 1.5%			
Mass reduction (MS2) 3.5 - 8.5%			

The estimates of vehicle compliance costs cover the years of implementation of the program – 2012 through 2016. In EPA’s analysis, compliance costs have also been estimated for the years following implementation to shed light on the long term – 2022 and later – cost impacts of the proposal. The year 2022 is used by EPA because the short-term and long-term markup factors described above are applied in five year increments with the 2012 through 2016 implementation span and the 2017 through 2021 span both representing the short-term.

The technology costs used in the Volpe Model are shown in the cost tables below. The Volpe Model handles learning effects within the model itself so that individual

technology costs in the 2016 model year would be lower than those in previous years. The costs in those tables are for model year 2016 vehicles and, therefore, represent fully learned costs in the context of EPA's analysis. For technologies added in years prior to 2016, EPA has backed out the learning effects relative to the costs shown in the tables. For example, the small car stop-start vehicle cost is \$351 in 2016. In the 2012 model year, this cost would be higher since the volume-based learning reflected in the 2016 cost would not have occurred yet. Backing out two volume-based learning steps (i.e., dividing \$351 by 80% twice) would result in a 2012 cost estimate of \$548.

While the agencies believe that the ideal estimates for the final rule would be based on tear down studies or BOM approach and subjected to a transparent peer-reviewed process, NHTSA and EPA are confident that the thorough review conducted, led to the best available conclusion regarding technology costs and effectiveness estimates for the current rulemaking and resulted in excellent consistency between the agencies' respective analyses for developing the CAFE and CO₂ standards.

2. Individual technology descriptions and cost/effectiveness estimates

(a) Gasoline Engine Technologies

(i) Overview

Most passenger cars and light trucks in the U.S. have gasoline-fueled spark ignition internal combustion engines. These engines move the vehicle by converting the chemical energy in gasoline fuel to useful mechanical work output as shaft torque and power delivered to the transmission and to the vehicle's driving wheels. Vehicle fuel economy is directly proportional to the efficiency of the engine. Two common terms are used to define the efficiency of an engine are (1) Brake Specific Fuel Consumption (BSFC), which is the ratio of the mass of fuel used to the output mechanical energy; and (2) Brake Thermal Efficiency (BTE), which is the ratio of the fuel chemical energy, known as calorific value, to the output mechanical energy.

The efficiency of an automotive spark ignition engine varies considerably with the rotational speed and torque output demanded from the engine. The most efficient operating condition for most current engine designs occurs around medium speed (30-50 percent of the maximum allowable engine rpm) and typically between 70-85 percent of maximum torque output at that speed. At this operating condition, BTE is typically 33-36 percent. However, at lower engine speeds and torque outputs, at which the engine operates in most consumer vehicle use and on standardized drive cycles, BTE typically drops to 20-25 percent.

Spark ignition engine efficiency can be improved by reducing the energy losses that occur between the point of combustion of the fuel in the cylinders to the point where that energy reaches the output crankshaft. Reduction in this energy loss results in a greater proportion of the chemical energy of the fuel being converted into useful work. For improving engine efficiency at lighter engine load demand points, which are most relevant for CAFE fuel economy, the technologies that can be added to a given engine may be characterized by which type of energy loss is reduced, as shown in Table V-17 below.

Table V-17 Technology Characterization by Type of Loss Reduced

Technology	Heat Loss Reduction	Exhaust Energy Reduction	Gas Exchange Reduction	Friction Reduction
Low Friction Lubricants				✓
Engine Friction Reduction				✓
VVT - Coupled Cam Phasing (CCP) on SOHC			✓	
Discrete Variable Valve Lift (DVVL) on SOHC			✓	
Cylinder Deactivation on SOHC			✓	
VVT - Intake Cam Phasing (ICP)			✓	
VVT - Dual Cam Phasing (DCP)			✓	
Discrete Variable Valve Lift (DVVL) on DOHC			✓	
Continuously Variable Valve Lift (CVVL)			✓	
Cylinder Deactivation on DOHC			✓	
Cylinder Deactivation on OHV			✓	
VVT - Coupled Cam Phasing (CCP) on OHV			✓	
Discrete Variable Valve Lift (DVVL) on OHV			✓	
Conversion to DOHC with DCP			✓	
Stoichiometric Gasoline Direct Injection (GDI)		✓		
Combustion Restart				✓
Turbocharging and Downsizing			✓	✓
Exhaust Gas Recirculation (EGR) Boost		✓	✓	✓
Conversion to Diesel	✓	✓	✓	

✓ Represents area of primary influence

As Table V-17 shows, the main types of energy losses that can be reduced in gasoline engines to improve fuel economy are exhaust energy losses, engine friction losses, and gas exchange losses. Converting the gasoline engine to a diesel engine can also reduce heat losses.

Exhaust Energy Loss Reduction

Exhaust energy includes the kinematic and thermal energy of the exhaust gases, as well as the wasted chemical energy of unburned fuel. These losses represent approximately 32 percent of the initial fuel chemical energy and can be reduced in three ways: first, by recovering mechanical or electrical energy from the exhaust gases; second, by improving the hydrocarbon fuel conversion; and third, by improving the cycle thermodynamic efficiency. The thermodynamic efficiency can be improved by either increasing the engine's compression ratio or by operating with a lean air/fuel ratio. The latter is not considered to be at the emerging technology point yet due to the non-availability of lean NO_x aftertreatment, as discussed below. However, the compression ratio may potentially be raised by 1 to 1.5 ratios using stoichiometric direct fuel injection.

Engine Friction Loss Reduction

Friction losses can represent a significant proportion of the global losses at low load. These losses are dissipated through the cooling system in the form of heat. Besides via direct reduction measures, friction can also be reduced through downsizing the engine by means of increasing the engine-specific power output.

Gas Exchange Loss Reduction

The energy expended while delivering the combustion air to the cylinders and expelling the combustion products is known as gas exchange loss, commonly referred to as pumping loss. The main source of pumping loss in a gasoline engine is the use of an inlet air throttle, which regulates engine output by controlling the pre-combustion cylinder air pressure, but is an inefficient way to achieve this pressure control. A more efficient way of controlling the cylinder air pressure is to modify the valve timing or lift. Another way to reduce the average pumping losses is to “downsize” the engine, making it run at higher loads or higher pressures.

Several different technologies target pumping loss reduction, but it is important to note that the fuel consumption reduction from these technologies is not necessarily cumulative. Once most of the pumping work has been eliminated, adding further technologies that also target reduced pumping loss will have little additional effectiveness. Thus, in the revised decision trees, the effectiveness value shown for additional technologies targeting pumping loss depends on the existing technology combination already present on the engine.

a. Engine Technologies

NHTSA and EPA have reviewed the engine technology estimates used in NHTSA’s MY 2011 CAFE final rule and EPA’s 2008 staff report. In doing so NHTSA and EPA reconsidered all available sources and updated as appropriate. The section below describes each of the engine technologies considered for this rulemaking.

(1) Low Friction Lubricants (LUB)

One of the most basic methods of reducing fuel consumption in gasoline engines is the use of lower viscosity engine lubricants. More advanced multi-viscosity engine oils are available today with improved performance in a wider temperature band and with better lubricating properties. This can be accomplished by changes to the oil base stock (*e.g.*, switching engine lubricants from a Group I base oils to lower-friction, lower viscosity Group III synthetic) and through changes to lubricant additive packages (*e.g.*, friction modifiers and viscosity improvers). The use of 5W-30 motor oil is now widespread and auto manufacturers are introducing the use of even lower viscosity oils, such as 5W-20 and 0W-20, to improve cold-flow properties and reduce cold start friction. However, in some cases, changes to the crankshaft, rod and main bearings and changes to the mechanical tolerances of engine components may be required. In all cases, durability testing would be required to ensure that durability is not compromised. The shift to lower viscosity and lower friction lubricants will also improve the effectiveness of valvetrain technologies such as cylinder deactivation, which rely on a minimum oil temperature (viscosity) for operation.

Several manufacturers have previously commented confidentially, as noted in NHTSA’s MY 2011 final rule, that low friction lubricants could have an effectiveness value between 0 to 1 percent. For purposes of this NPRM, NHTSA is using the same effectiveness estimate of 0.5 percent as it did in the MY 2011 final rule and is within the manufacturers’ estimated range.

The 2002 NAS study estimated the low friction lubricant RPE at \$8 to \$11 using a 1.4 markup factor. The NESCCAF study showed an RPE of \$5 to \$15 with a 1.4

markup. The EEA report to DOE showed manufacturer costs of \$10 to \$20 with no markup. In the MY 2001 final rule, NHTSA noted that manufacturer Confidential Business Information (CBI) data estimated an average incremental cost of \$3 for the use of low friction lubricants. EPA's 2008 Staff Report also confirms this \$3 cost. NHTSA believes that manufacturer's estimates are the most accurate, and thus continue to believe that the \$3 cost estimate is appropriate and independent of vehicle class since the engineering work required should apply to any engine size. Applying an indirect cost multiplier (ICM) of 1.11, for a low complexity technology, results in a compliance cost of \$3.33 per vehicle for a MY 2012 vehicle. The costs developed for low friction lubes reflects the costs associated with any engine changes that would be required as well as any durability testing.

Neither volume-based cost reductions nor time-based cost reductions are applied to low friction lubricants. This technology is presumed to be significantly dependent on commodity raw material prices and to be priced independent of particular design or manufacturing savings. This technology can be applied to any vehicle class with a phase-in of 100 percent starting in MY 2012.

(2) Engine Friction Reduction (EFR)

In addition to low friction lubricants, manufacturers can also reduce friction and improve fuel consumption by improving the design of engine components and subsystems. Approximately 10 percent of the energy consumed by a vehicle is lost to friction, and just over half is due to frictional losses within the engine.¹²² Examples include improvements in low-tension piston rings, piston skirt design, roller cam followers, improved crankshaft design and bearings, material coatings, material substitution, more optimal thermal management, and piston and cylinder surface treatments. Additionally, as computer-aided modeling software continues to improve, more opportunities for evolutionary friction reductions may become available.

All reciprocating and rotating components in the engine are potential candidates for friction reduction, and minute improvements in several components can add up to a measurable fuel economy improvement. The 2002 NAS, NESCCAF and EEA reports as well as confidential manufacturer data suggested a range of effectiveness for engine friction reduction to be between 1 to 3 percent. NHTSA continues to believe that this range is accurate. Because of the incremental nature of the Volpe model, NHTSA needed to continue to use the narrower range of 1-2 percent, which was also used in the MY 2011 CAFE final rule.

In the MY 2011 CAFE final rule, NHTSA estimated a range from \$13 to \$49 using a 1.5 RPE on a per cylinder basis, or \$9 to \$33 without RPE. In the 2008 NPRM engine friction reduction was estimated to cost up to \$14 without RPE on a per cylinder basis. After review, NHTSA believes that the cost estimate is closer to the lower end of

¹²² "Impact of Friction Reduction Technologies on Fuel Economy," Fenske, G. Presented at the March 2009 Chicago Chapter Meeting of the 'Society of Tribologists and Lubricated Engineers' Meeting, March 18th, 2009. Available at: <http://www.chicagostle.org/program/2008-2009/Impact%20of%20Friction%20Reduction%20Technologies%20on%20Fuel%20Economy%20-%20with%20VGs%20removed.pdf> (last accessed July 9, 2009).

the MY 2011 CAFE final rule range and thus for this rulemaking has a compliance cost of \$13 per cylinder, including the low complexity ICM markup value of 1.11, for a MY 2012 vehicle. These costs are multiplied by the number of engine cylinders for Volpe modeling purposes. Thus a cost of \$50 was used for a 4-cylinder engine, \$75 for a 6-cylinder engine and \$101 for an 8-cylinder engine for this NPRM.

Engine friction-reducing technologies may be applied to all vehicle classes. No learning factors were applied to costs as the technology has a loosely defined BOM which may in part consist of materials (surface treatments, raw materials) that are commodity based. As confirmed by manufacturers' comments, NHTSA has maintained as it did in the MY 2011 final rule, that engine friction reduction may only be applied in conjunction with a refresh or redesign cycle. Engine friction has phase-in cap of 85 percent from MY 2012 to 2014 and then increases to 100 percent for the rest of this rule making period.

(3) Variable Valve Timing (VVT)

Variable valve timing (VVT) classifies a family of valve-train designs that alter the timing of the intake valve, exhaust valve, or both, primarily to reduce pumping losses, increase specific power, and control the level of residual gases in the cylinder. VVT reduces pumping losses when the engine is lightly loaded by controlling valve timing closer to the optimum point needed to sustain horsepower and torque. VVT can also improve volumetric efficiency at higher engine speeds and loads. Additionally, VVT can be used to alter (and optimize) the effective compression ratio where it is advantageous for certain engine operating modes (*e.g.*, in the Atkinson Cycle).

VVT has now become a widely adopted technology: in MY 2007, over half of all new cars and light trucks had engines with some method of variable valve timing.¹²³ Manufacturers are currently using many different types of variable valve timing, which have a variety of different names and methods. Therefore, the degree of further improvement across the fleet is limited by the level of valvetrain technology already implemented on the vehicles. Information found in the 2008 baseline vehicle fleet file is used to determine the degree to which VVT technologies have already been applied to particular vehicles to ensure the proper level of VVT technology, if any, is applied. The three major types of VVT are listed below.

Each of the three implementations of VVT uses a cam phaser to adjust the camshaft angular position relative to the crankshaft position, referred to as "camshaft phasing." The phase adjustment results in changes to the pumping work required by the engine to accomplish the gas exchange process. The majority of current cam phaser applications use hydraulically-actuated units, powered by engine oil pressure and managed by a solenoid that controls the oil pressure supplied to the phaser.

¹²³ "Light-Duty Automotive Technology and Fuel Economy Trends: 1975 Through 2007", EPA420-S-07-001, September 2007. Available at <http://www.epa.gov/oms/cert/mpg/fetrends/fetrends-archive.htm> (last accessed July 9, 2009).

(a) **Intake Cam Phasing (ICP)**

Valvetrains with ICP, which is the simplest of the cam phasing technologies, can modify the timing of the inlet valves by phasing the intake camshaft while the exhaust valve timing remains fixed. This requires the addition of a cam phaser on each bank of intake valves on the engine. An in-line 4-cylinder engine has one bank of intake valves, while V-configured engines have two banks of intake valves.

NHTSA's MY 2011 CAFE final rule and EPA 2008 Staff Report estimated an effectiveness of 1 to 2 percent for ICP, which was supported by the NESCCAF report and a majority of confidential manufacturer comments. NHTSA has found no additional sources to suggest strongly that this estimate is inaccurate, and so have continued to employ it for this NPRM.

As for costs, NHTSA's MY 2011 CAFE final rule estimated a \$61 RPE (\$41 non-RPE) cost per cam phaser, based on the 2008 Martec Report and confidential manufacturer data. NHTSA believes that this number remains accurate. Using the new indirect cost multiplier of 1.11, for a low complexity technology, the compliance cost per cam phaser would be \$45 per bank, yielding a \$45 cost for an in-line engine configurations and \$90 for V-engine configurations for a MY 2012 vehicle.

ICP is applicable to all vehicle classes, can be applied at the refresh or redesign cycles and is eligible for time-based learning. For this NPRM and as it did for the MY 2011 final rule, NHTSA has combined the phase-in caps for ICP, CCPS, CCPO and DCP. This combined phase-in cap is 85 percent from MY 2012 to 2014 and then increases to 100 percent for the rest of this rule making period.

(b) **Coupled Cam Phasing (CCPS and CCPO)**

Valvetrains with coupled (or coordinated) cam phasing can modify the timing of both the inlet valves and the exhaust valves an equal amount by phasing the camshaft of a single overhead cam (SOHC) engine or an overhead valve (OHV) engine. For overhead cam engines, this requires the addition of a cam phaser on each bank of the engine. Thus, an in-line 4-cylinder engine has one cam phaser, while SOHC V-engines have two cam phasers. For overhead valve (OHV) engines, which have only one camshaft to actuate both inlet and exhaust valves, CCP is the only VVT implementation option available and requires only one cam phaser.¹²⁴

Based on NHTSA's MY 2011 CAFE final rule, previously-received confidential manufacturer data, and the NESCCAF report, NHTSA estimated the effectiveness of CCP to be between 1 to 4 percent. NHTSA reviewed this estimate for purposes of the NPRM, and continue to find it accurate. Due to the incremental nature and decision tree logic of the Volpe model, NHTSA estimated the effectiveness for CCPS to be 1 to 3 percent and 1 to 1.5 percent for CCPO.

The same cam phaser has been assumed for ICP and CCP applications, thus CCP's cost per cam phaser is identical to ICP's. This results in a cost of \$45 for in-line

¹²⁴ It is also noted that coaxial camshaft developments would allow other VVT options to be applied to OHV engines. However, since they would potentially be adopted on a limited number of OHV engines NHTSA did not include them in the decision tree.

SOHC and OHV engines and \$90 for SOHC V-engine configurations for a MY 2012 vehicle with time-based learning applied.

CCP is applicable to all vehicle classes and can be applied at refresh or redesign. For purposes of this NPRM as in the MY 2011 final rule, NHTSA has combined the phase-in caps for ICP, CCPS, CCCPO and DCP. This combined phase-in cap is 85 percent from MY 2012 to 2014 and then increases to 100 percent for the rest of this rule making period.

(c) **Dual Cam Phasing (DCP)**

The most flexible VVT design is dual (independent) cam phasing, where the intake and exhaust valve opening and closing events are controlled independently. This option allows the option of controlling valve overlap, which can be used as an internal EGR strategy. At low engine loads, DCP creates a reduction in pumping losses, resulting in reduction in fuel consumption. Increased internal EGR also results in lower engine-out NO_x emissions. The amount by which fuel consumption is improved depends on the residual tolerance of the combustion system. Additional improvements are observed at idle, where low valve overlap could result in improved combustion stability, potentially reducing idle fuel consumption.

In the MY 2011 final rule, NHTSA estimated the effectiveness of DCP to be between 2 to 3 percent relative to an engine with ICP. NHTSA believes that this estimate remains applicable for the NPRM.

As with CCP, the same cam phaser has been assumed for ICP and DCP applications. Thus, DCP's cost per cam phaser is identical to ICP's. DCP requires two cam phasers per cylinder bank, one to control the intake valves and one to control the exhaust valves. This results in a cost of \$90, relative to an engine without ICP, or \$45 relative to an engine with ICP, minus \$6 for the removal of the EGR valve, ultimately yielding costs of \$84 and \$39 respectively for in-line DOHC configurations. For V-configuration engines, the cost is \$180 relative to an engine without ICP, or \$90 relative to an engine with ICP, minus \$6 for the removal of the EGR valve, ultimately yielding costs of \$174 and \$84, respectively. These costs are appropriate for a MY 2012 vehicle application.

DCP can be applied to all of the vehicle classes at vehicle refresh. Time-based leaning is applied and NHTSA has combined the phase-in caps of ICP, CCPS, CCPO and DCP with a combined cap of 85 percent for MY 2012 to 2014 and increases to 100 percent for the rest of this rule making period.

(4) **Variable Valve Lift (VVL)**

Controlling the lift of the valves provides a potential for further efficiency improvements. By optimizing the valve-lift profile for specific engine operating regions, the pumping losses can be reduced by reducing the amount of throttling required to produce the desired engine power output. By moving the throttling losses further downstream of the throttle valve, the heat transfer losses that occur from the throttling process are directed into the fresh charge-air mixture just prior to compression, delaying the onset of knock-limited combustion processes. Variable valve lift control can also be used to induce in-cylinder mixture motion, which improves fuel-air mixing and can result

in improved thermodynamic efficiency. Variable valve lift control can also potentially reduce overall valvetrain friction. At the same time, such systems may also incur increased parasitic losses associated with their actuation mechanisms. A number of manufacturers have already implemented VVLT into their fleets (Toyota, Honda, and BMW), but overall this technology is still available for most of the fleet. There are two major classifications of variable valve lift, described below:

Discrete Variable Valve Lift (DVVLS, DVVLD, DVVLO)

DVVL systems allow the selection between two or three discrete cam profiles by means of a hydraulically-actuated mechanical system. By optimizing the cam profile for specific engine operating regions, the pumping losses can be reduced by reducing the amount of throttling required to produce the desired engine power output. This increases the efficiency of the engine. These cam profiles consist of a low and a high-lift lobe, and may include an inert or blank lobe to incorporate cylinder deactivation (in the case of a 3-step DVVL system). DVVL is normally applied together with VVT control. DVVL is also known as Cam Profile Switching (CPS). DVVL is a mature technology with low technical risk.

NHTSA's MY 2011 CAFE final rule, previously-received confidential manufacturer data, and the NESCCAF report, all estimate the effectiveness of DVVL to be between 1 to 4 percent above that realized by VVT systems. NHTSA believes this estimate continues to be applicable for the NPRM and continues to use the same effectiveness estimates as it did in the MY 2011 final rule as described in the preceding sentences. Taking into account the incremental nature and decision tree logic of Volpe modeling, NHTSA has estimated an incremental reduction in fuel consumption for DVVLS and DVVLD of 1 to 3 percent. On OHV engines, DVVLO is applied following both VVT and cylinder deactivation, therefore the effectiveness estimate is at a slightly lower range of 0.5 to 2.5 percent.

In the 2011 CAFE final rule, NHTSA estimated an RPE (1.5) cost of \$201 for an inline 4-cylinder engine, \$306 for a V6 engine and \$396 for a V8 engine or without RPE \$134, \$204, \$264, respectively. After review, NHTSA, in consultation with EPA, has chosen to use the NESCCAF report as the basis for the discrete variable valve lift cost. The NESCCAF estimates were converted to 2007 dollars, updated for a MY 2012 application, increased by \$25 for additional controls hardware and multiplied by the low complexity ICM markup factor of 1.11. For this NPRM, NHTSA is using a compliance cost estimate of \$141 for an inline 4-cylinder engine, \$205 for a V6 engine and \$293 for a V8 engine.

This technology may be applied to any class of vehicles with any kind of engine at the redesign cycle. NHTSA has combined the phase-in caps for DVVLS, DVVLD, DVVLO and CVVL, as it did in the MY 2011 final rule, and capped the joint penetration allowed at 85 percent in MY 2012 to 2014 and increases to 100 percent for the rest of this rule making period with time-based learning applied.

1. Continuously Variable Valve Lift (CVVL)

In CVVL systems, valve lift is varied by means of a mechanical linkage, driven by an actuator controlled by the engine control unit. The valve opening and phasing vary

as the lift is changed and the relation depends on the geometry of the mechanical system. BMW has extensive production experience with CVVL systems and has sold port-injected “Valvetronic” engines since 2001. CVVL allows the airflow into the engine to be regulated by means of intake valve opening reduction, which improves engine efficiency by reducing pumping losses from throttling the intake system further upstream as with a conventionally throttled engine.

Variable valve lift gives a further reduction in pumping losses compared to that which can be obtained with cam phase control only, with CVVL providing greater effectiveness than DVVL, since it can be fully optimized for all engine speeds and loads, and is not limited to a two or three step compromise. There may also be a small reduction in valvetrain friction when operating at low valve lift, resulting in improved low load fuel consumption for cam phase control with variable valve lift as compared to cam phase control only. Most of the fuel economy effectiveness is achieved with variable valve lift on the intake valves only. CVVL is only applicable to double overhead cam (DOHC) engines.

NHTSA’s MY 2011 CAFE final rule estimated the effectiveness for CVVL at 1.5 to 3.5 percent over an engine with DCP, but also recognize that it could go up as high as 5% above and beyond DCP to account for the implementation of more complex CVVL systems such as BMW’s “valvetronic” engines. This coincides with EPA Staff report estimates of the contribution of CVVL, which were based on the NESCCAF report, in which CVVL could improve effectiveness by 4 percent (minivans) and up to 6 percent (large cars) over dual cam phasing. For this NPRM, NHTSA has continued to use the 1.5 to 3.5 percent range from the MY 2011 final rule. However, due to the complexity and cost of this technology, the Volpe model projected very limited applications of this technology (i.e., 2 out of 1100 vehicles). The most recent submission of manufacturers’ product plans confirmed that this technology will not be applied by most manufacturers.

In the MY 2011 CAFE final rule, NHTSA estimated and RPE (1.5) cost of continuously variable valve lift to be \$306 for an inline 4-cylinder engine, \$432 for a V6 engine and \$582 for a V8 engine or without RPE \$204, \$287, \$388, respectively. After review, NHTSA in consultation with EPA has chosen to use the NESCCAF report as the basis for the discrete variable valve lift cost. The NESCCAF estimates were converted to 2007 dollars, updated for a MY 2012 application, increased by \$25 for additional controls hardware and multiplied by the low complexity ICM markup factor of 1.45. For this NPRM, NHTSA estimated a cost of \$277 for an inline 4-cylinder engine, \$509 for a V6 engine and \$554 for a V8 engine with time-based learning applied.

There are no class specific applications of this technology, although it appears in only the DOHC portion of the decision tree. Due to the changes required to implement CVVL on an engine the Volpe model allows it to be applied at redesign model years only with time-based learning applied. NHTSA has combined the phase-in caps for DVVLS, DVVLD, DVVLO and CVVL, as in the MY 2011 final rule, and capped the joint penetration allowed at 85 percent in MY 2012 to 2014 and the increases to 100 percent for the rest of this rule making period.

(5) Cylinder Deactivation (DEACS, DEACD, DEACO)

In conventional spark-ignited engines throttling the airflow controls engine torque output. At partial loads, efficiency can be improved by using cylinder deactivation

instead of throttling. Cylinder deactivation (DEAC) can improve engine efficiency by disabling or deactivating (usually) half of the cylinders when the load is less than half of the engine's total torque capability – the valves are kept closed, and no fuel is injected – as a result, the trapped air within the deactivated cylinders is simply compressed and expanded as an air spring, with reduced friction and heat losses. The active cylinders combust at almost double the load required if all of the cylinders were operating. Pumping losses are significantly reduced as long as the engine is operated in this “part-cylinder” mode.

Cylinder deactivation control strategy relies on setting maximum manifold absolute pressures or predicted torque within which it can deactivate the cylinders. Noise and vibration issues reduce the operating range to which cylinder deactivation is allowed, although manufacturers are exploring vehicle changes that enable the possibility of increasing the amount of time that cylinder deactivation might be suitable. Some manufacturers may choose to adopt active engine mounts and/or active noise cancellations systems to address NVH concerns and to allow a greater operating range of activation. Manufacturers have stated that use of DEAC on 4 cylinder engines would cause unacceptable NVH issues; therefore cylinder deactivation has not been applied to 4-cylinder engines.

Cylinder deactivation has seen a recent resurgence thanks to better valvetrain designs and engine controls. General Motors and Chrysler Group have incorporated cylinder deactivation across a substantial portion of their V8-powered lineups. Honda (Odyssey, Pilot) offers V6 models with cylinder deactivation.

Effectiveness improvements scale roughly with engine displacement-to-vehicle weight ratio: the higher displacement-to-weight vehicles, operating at lower relative loads for normal driving, have the potential to operate in part-cylinder mode more frequently.

NHTSA reviewed the MY 2011 CAFE estimates and confirmed their appropriateness for this NPRM. The Volpe model, due to its incremental nature, uses a range depending on the engine valvetrain configuration. For example, for DOHC engines which are already equipped with DCP and DVVLD, there is little benefit that can be achieved from adding cylinder deactivation since the pumping work has already been minimized and internal Exhaust Gas Recirculation (EGR) rates are maximized, so the effectiveness range for DEACD is 0.0 to 0.5 percent. For SOHC engines which have CCP and DVVLS applied, effectiveness ranged from 2.5 to 3 percent for DEACS. For OHV engines, without VVT or VVL technologies, the effectiveness for DEACO ranged from 3.9 to 5.5 percent.

NHTSA considered a range of \$28 to \$190 depending on whether an engine already has lost motion devices, oil control valves and camshaft position sensors. This is a departure from NHTSA's 2011 final rule, which uses a range of \$306 to \$400. That range was primarily based on 2008 Martec Report and applied a higher RPE value. In reviewing these assumptions, NHTSA in consultation with EPA amended the MY 2011 CAFE estimates and adjusted the estimates to include the new ICM low complexity markup of 1.11. The EPA staff report and NHTSA's NPRM showed estimates of a \$170 for a 6-cylinder engine and \$190 for an 8-cylinder engine when adjusted for 2007 dollars and using the new ICM multipliers for engines that do not have lost motion devices. These numbers were within the ranges described by the 2002 NAS and NESCCAF reports. For Volpe modeling purposes, these costs are appropriate for DEACO on OHV

engines. If lost motion devices are on the engine, as is the case for SOHC and DOHC engines based on the decision tree logic, the cost of DEACS and DEACD ranges from \$0 to \$56. This \$0 to \$56 range¹²⁵ accounts for the potential additional application of active engine mounts on SOHC and DOHC engines and can only be applied on 50 percent of the vehicles.

This technology may be applied only to V-6 and V-8 engines, as discussed above, and so does not apply to vehicle classes with I-4 engines. DEAC can be applied during a redesign or refresh model year with time-based learning. NHTSA has combined the phase-in caps for DEACS, DEACD and DEACO, as it did in MY 2011 final rule, and capped the joint penetration allowed at 85 percent for MY 2012 and beyond.

(6) **Conversion to Double Overhead Camshaft Engine with Dual Cam Phasing (CDOHC)**

Double overhead camshaft engines achieve increased airflow at high engine speeds, improve volumetric efficiency and reductions of the valvetrain's moving mass. Such engines typically develop higher power at high engine speeds. Manufacturers may choose to replace OHV engines with DOHC engine designs with dual cam phasing (DCP). NHTSA continues to use the fuel consumption reduction estimate of 1 to 2.5 percent, as it did in the MY 2011 final rule.

As for costs, NHTSA's MY 2011 CAFE final rule assumed that CDOHC would have an RPE cost of \$746 (\$497 non-RPE) for a V8 engine, \$590 (\$393 non-RPE) for a V6 engine and \$373 (\$249 non-RPE) for inline 4-cylinder engine. For purposes of this NPRM, NHTSA revised the costs only by identifying this technology as a low complexity technology and applying an indirect cost multiplier of 1.11 resulting in a compliance cost of \$552 for V8 engine, \$436 for a V6 and \$276 for an inline 4-cylinder engine.

There are no vehicle class-specific applications of this technology. The phase-in cap for CDOHC has been set at 85 percent per year for the 2012-2016 timeframe. The conversion from OHV to DOHC engine architecture with DCP is a major engine redesign that can be applied in redesign model years only with time-based learning applied.

(7) **Stoichiometric Gasoline Direct Injection (SGDI)**

Gasoline direct injection (GDI), or Spark Ignition Direct Injection (SIDI) engines inject fuel at high pressure directly into the combustion chamber (rather than the intake port in port fuel injection). GDI requires changes to the injector design, an additional high pressure fuel pump, new fuel rails to handle the higher fuel pressures and changes to the cylinder head and piston crown design. Direct injection of the fuel into the cylinder improves cooling of the air/fuel charge within the cylinder, which allows for higher compression ratios and increased thermodynamic efficiency without the onset of combustion knock. Recent injector design advances, improved electronic engine management systems and the introduction of multiple injection events per cylinder firing cycle promote better mixing of the air and fuel, enhance combustion rates, increase residual exhaust gas tolerance and improve cold start emissions. GDI engines achieve higher power density and match well with other technologies, such as boosting and variable valvetrain designs.

¹²⁵ The \$28 is an adjustment from the \$75 estimate used in the MY 2011 final rule to account for the new ICM markup factor and the fact that it could only be applied on up to 50 percent of the vehicles.

Several manufacturers have recently introduced vehicles with GDI engines, including VW/Audi, BMW, Toyota (Lexus IS 350) and General Motors (Chevrolet Impala and Cadillac CTS 3.6L). BMW, GM, Ford and VW/Audi have announced their plans to increase dramatically the number of GDI engines in their portfolios.

NHTSA's MY 2011 CAFE final rule estimated the effectiveness of SGDI to be between 2 and 3 percent. In developing these estimates, NHTSA reviewed estimates from the Auto Alliance of American Manufacturers, which projects 3 percent gains in fuel efficiency and a 7 percent improvement in torque. The torque increase provides the opportunity to mildly downsize the engine allowing an increase in efficiency of up to a 5.8 percent. NHTSA also reviewed other published literature, reporting 3 percent effectiveness for SGDI.¹²⁶ Another source reports a 5 percent improvement on the NEDC drive cycle.¹²⁷ Confidential manufacturer data reported an efficiency effectiveness range of 1 to 2 percent. NHTSA determined that the range of 2 to 3 percent continues to be appropriate. However, NHTSA notes that combined with other technologies (*i.e.*, boosting, downsizing, and in some cases, cooled EGR), SGDI can achieve greater reductions in fuel consumption and CO₂ emissions compared to engines of similar power output.

In reviewing the MY 2011 estimates, NHTSA in coordination with EPA revised the cost estimates for SGDI to take into account the changes required to the engine hardware, engine electronic controls, ancillary and Noise Vibration and Harshness (NVH) mitigation systems. Through contacts with industry NVH suppliers, and manufacturer press releases, the agency believes that the NVH treatments will be limited to the mitigation of fuel system noise, specifically from the injectors and the fuel lines. To that end, the NHTSA reduced the cost assumptions to \$251 for an inline 4-cylinder and \$326 for V6 and \$353 for V8 including the low complexity ICM markup value of 1.11. The preceding costs are for a MY 2012 vehicle and are eligible for time-based learning.

SGDI systems are regarded as mature technology with minimal technical risk and are expected to be increasingly incorporated into manufacturers' product lineups. Time-based learning has been applied to this technology due to the fact that over 1.5 million vehicles containing this technology are now produced annually. Due to the changes to the cylinder head and combustion system and the control system development required to adopt SGDI technology, which are fairly extensive, SGDI can be applied only at redesign model years. There are no limitations on applying SGDI to any vehicle class. The phase-in cap for SGDI is applied at a 85 percent rate for MY 2012 and beyond.

¹²⁶ Paul Whitaker, Ricardo, Inc., "Gasoline Engine Performance And Emissions – Future Technologies and Optimization," ERC Symposium, Low Emission Combustion Technologies for Future IC Engines, Madison, WI, June 8-9, 2005. Available at http://www.erc.wisc.edu/symposiums/2005_Symposium/June%208%20PM/Whitaker_Ricardo.pdf (last accessed Nov. 9, 2008).

¹²⁷ Stefan Trampert, FEV Motorentechnik GmbH, "Engine and Transmission Development Trends - Rising Fuel Cost Pushes Technology," Symposium on International Automotive Technology, Pune, India, January 2007.

(8) Combustion Restart (CBRST)

Combustion restart allows “start-stop” functionality of DI engines through the implementation of an upgraded starter with bi-directional rotation to allow precise crankshaft positioning prior to subsequent fuel injection and spark ignition, allowing engine restart. This method of implementing engine stop/start functionality allows not only the fuel savings from not idling the engine, but also reduces fuel consumption as the engine speeds up to its operational speed. A Direct Injection (DI) fuel system is required for implementation of this technology.

NHTSA reviewed the MY 2011 CAFE final rule assumptions and determined that due to technical risks with its implementation, this technology will be made available in the CAFE model in MY 2014 at the earliest. Some of the risks are associated with unresolved issues regarding the impact of very high or very low ambient air temperatures on the ability to start the engine in the described manner. Although the starter motor can provide fail-safe starting capability in these temperature limited areas, strategies must be developed to manage the transitions. Others relate to production readiness.

Additional hardware is required to implement combustion restart, beyond SGDI. This includes a battery sensor, incremental wiring and high current switching, an incremental crank position sensor, and, in the case of an automatic transmission applications, a transmission oil pump to allow for torque converter continuity.

BMW has published a 3.5 percent fuel consumption effectiveness over the NEDC drive cycle for combustion restart,¹²⁸ and AVL a 4.8 percent effectiveness.¹²⁹ However, these reported effectiveness levels could potentially be reduced significantly on the EPA combined drive cycle, as combustion restart does not save fuel on the highway drive cycle. Therefore, NHTSA estimates the fuel consumption effectiveness for CBRST to range from 2 to 2.5 percent.

Regarding the cost estimate, NHTSA determined that the estimate of \$118 from the 2008 Martec Report cost estimates for individual pieces was the best available. The total RPE cost (excluding transmission pump) is \$141 at high volumes, which includes \$70 for upgrading the starter, \$10 for a battery sensor and wiring, \$10 for high current switch and \$4 for crank sensor a totaling \$94 (non-RPE) cost. Applying an indirect cost multiplier of 1.25, for a medium complexity technology, results in a compliance cost of \$118 for a MY 2012 vehicle and will be reduced in future years with the application of time-based learning.

¹²⁸ Stefan Wolff, Dirk Abendroth, Werner Weigl, Claus-Peter Linner, Rupert Neudecker, Michael Schneider, Wolfgang Huber, and Andreas Rau, BMW, “Introducing The Automatic Start-Stop (ASS) Function In Series Models,” 7th Stuttgart Automotive Vehicle and Engine Symposium, Organised by FKFS, Mar 2007, Vol. 1.

¹²⁸ G.K. Fraidl, P.E. Kapus, and H. Friedl, AVL List GmbH, “Future Gasoline Engine Technologies for 130 g/Km

¹²⁹ G.K. Fraidl, P.E. Kapus, and H. Friedl, AVL List GmbH, “Future Gasoline Engine Technologies for 130 g/Km CO₂,” VKM-THD 11th Symposium on the Working Process of Combustion Engines, TU Graz, Sept. 2007.

CBRST is first available in MY 2014 and is applicable to all vehicle classes. Confidential product plan data indicates CBRST to be at high volume by 2014 so time-based learning is applied. CBRST can be applied a vehicle refresh .

(9) **Turbocharging and Downsizing (TRBDS)**

The specific power of a naturally aspirated engine is primarily limited by the rate at which the engine is able to draw air into the combustion chambers. Turbocharging and supercharging (grouped together here as boosting) are two methods to increase the intake manifold pressure and cylinder charge-air mass above naturally aspirated levels. Boosting increases the airflow into the engine, thus increasing the specific power level, and with it the ability to reduce engine displacement while maintaining performance. This effectively reduces the pumping losses at lighter loads in comparison to a larger, naturally aspirated engine.

Almost every major manufacturer currently markets a vehicle with some form of boosting. While boosting has been a common practice for increasing performance for several decades, turbocharging has considerable potential to improve fuel economy when the engine displacement is also reduced. Specific power levels for a boosted engine often exceed 100 hp/L, compared to average naturally aspirated engine power densities of roughly 70 hp/L. As a result, engines can conservatively be downsized roughly 30 percent to achieve similar peak output levels. In the last decade, improvements to turbocharger turbine and compressor design have improved their reliability and performance across the entire engine operating range. New variable geometry turbines and ball-bearing center cartridges allow faster turbocharger spool-up (virtually eliminating the once-common “turbo lag”) while maintaining high flow rates for increased boost at high engine speeds. However, even with turbocharger improvements, maximum engine torque at very low engine speed conditions, for example launch from standstill, is increased less than at mid and high engine speed conditions. The potential to downsize engines may be less on vehicles with low displacement to vehicle mass ratios in order to provide adequate acceleration from standstill, particularly up grades or at high altitudes.

Use of GDI systems with turbocharged engines and air-to-air charge air cooling also reduces the fuel octane requirements for knock limited combustion and allows the use of higher compression ratios. Ford’s “Ecoboost” downsized, turbocharged GDI engines introduced on MY 2010 vehicles allow the replacement of V8 engines with V6 engines with improved in 0-60 mph acceleration and with fuel economy improvements of up to 12 percent.¹³⁰

NHTSA estimates a turbocharged and downsized engine will improve fuel consumption by 1.8% to 4.8% incrementally over an equivalent performance naturally-aspirated SGDI engine taking into account previously applied technologies (e.g., VVT

¹³⁰ “Development and Optimization of the Ford 3.5L V6 EcoBoost Combustion System,” Yi,J., Wooldridge, S., Coulson, G., Hilditch, J. Iyer, C.O., Moilanen, P., Papaioannou, G., Reiche, D. Shelby, M., VanDerWege, B., Weaver, C. Xu, Z., Davis, G., Hinds, B. Schamel, A. SAE Technical Paper No. 2009-01-1494, 2009.

and VVL) as defined on the decision tree. The range of incremental fuel consumption improvement for each engine is also based on which decision tree path (i.e. SOHC, DOHC or OHV) the engine is following. This is similar to estimates used in the 2011 final rule. This would equate to a 12 to 14 effectiveness improvement over baseline fixed-valve engine, similar to the estimate for Ford's Ecoboost.

Recently published data with advanced spray-guided injection systems and more aggressive engine downsizing targeted towards reduced fuel consumption indicate that the potential for reducing fuel consumption for turbocharged, downsized GDI engines may be as much as 15 to 30% relative to port-fuel-injected engines.^{131 132 133 134 135} NHTSA seeks comment on how best to determine these values. Confidential manufacturer data suggests an incremental range of fuel consumption of 4.8 to 7.5 percent for turbocharging and downsizing. Other publicly-available sources suggest a fuel consumption of 8 to 13 percent compared to current-production naturally-aspirated engines without friction reduction or other fuel economy technologies: a joint technical paper by Bosch and Ricardo suggesting fuel economy gain of 8 to 10 percent for downsizing from a 5.7 liter port injection V8 to a 3.6 liter V6 with direct injection using a wall-guided direct injection system;¹³⁶ a Renault report suggesting a 11.9 percent NEDC fuel consumption gain for downsizing from a 1.4 liter port injection in-line 4-cylinder engine to a 1.0 liter in-line 4-cylinder engine, also with wall-guided direct injection;¹³⁷ and a Robert Bosch paper suggesting a 13 percent NEDC gain for downsizing to a turbocharged DI engine, again with wall-guided injection.¹³⁸ These reported fuel economy benefits show a wide range depending on the GDI technology employed.

¹³¹ Cairns *et al.*, Lotus, "Low Cost Solutions for Improved Fuel Economy in Gasoline Engines," Global Powertrain Congress September 27-29, 2005, vol. 33. Available at <http://www.gpc-icpem.org/pages/publications.html> (last accessed Nov. 9, 2008).

¹³² Tim Lake, John Stokes, Richard Murphy, and Richard Osborne of Ricardo and Andreas Schamel of Ford-Werke, "Turbocharging Concepts for Downsized DI Gasoline Engines," VKA/ika Aachen Colloquium 2003. Available at <http://cat.inist.fr/?aModele=afficheN&cpsid=16973598> (last accessed Nov. 9, 2008).

¹³³ "Interim Report: New Powertrain Technologies and Their Projected Costs," October 2005, EPA420-R-05-012.

¹³⁴ "Cost and Fuel Economy Comparison of Diesel and Gasoline Powertrains in Passenger Cars and Light Trucks," submitted by FEV Engine Technology, Inc., April 23, 2003, contained as Appendix I within EPA Interim Technical Report EPA420-R-04-002.

¹³⁵ "Electric Cars: Plugged In, Batteries must be included," Deutsche Bank Global Markets Research Company, June 9, 2008.

¹³⁶ David Woldring and Tilo Landefeld of Bosch, and Mark J. Christie of Ricardo, "DI Boost: Application of a High Performance Gasoline Direct Injection Concept," SAE 2007-01-1410. Available at <http://www.sae.org/technical/papers/2007-01-1410> (last accessed Nov. 9, 2008)

¹³⁷ Yves Boccadoro, Loïc Kermanac'h, Laurent Siauve, and Jean-Michel Vincent, Renault Powertrain Division, "The New Renault TCE 1.2L Turbocharged Gasoline Engine," 28th Vienna Motor Symposium, April 2007.

¹³⁸ Tobias Heiter, Matthias Philipp, Robert Bosch, "Gasoline Direct Injection: Is There a Simplified, Cost-Optimal System Approach for an Attractive Future of Gasoline Engines?" AVL Engine & Environment Conference, September 2005.

As noted above NHTSA, in coordination with EPA, relied on engine teardown analyses conducted by EPA, FEV and Munro to develop costs for turbocharged GDI engines. A copy of this report can be found the NHTSA docket: NHTSA-2009-0059. Teardown studies are the one of the most effective ways to estimate technology costs. The study showed the cost of a turbocharger (variable geometry turbo, air-to-air charge air cooler, auxiliary cooling pump, lubes, upgrades to the exhaust manifold, and necessary controls) for the I4 DOHC engine studied to be \$372. The study also showed an engine downsizing savings for downsizing a 2.4L DOHC engine to a 1.6L DOHC engine of \$60. These savings were the result of reduced bore spacing, a shorter camshaft and crankshaft, removal of two balance shafts and associated hardware, and a smaller intake manifold. These values (\$372 and -\$60) have been used for I4 engines adding boost and for I4 engines undergoing downsizing, respectively. Note that these two values become \$329 and -\$53 after four years of time-based learning (3 percent per year) in model year 2016.

EPA and NHTSA estimate direct manufacturing costs associated with downsizing to be \$50 per cylinder, \$10 per valve, and \$100 per cam shaft for the 2015 model year. Applying a 1 year of time-based learning to these costs, and adjusting them to 2007 dollars, results in 2016 direct manufacturing costs of \$50 per cylinder, \$10 per valve, and \$100 per cam shaft. A summary of the final costs and how they were calculated is shown in Table V-18. In order to get from the MY 2016 costs in the table to MY 2012 costs, four cycles of time-based learning needs to be applied.

NHTSA estimates that the MY 2012 incremental compliance cost, including a medium complexity ICM mark-up of 1.25, for a turbocharged and downsized engine is \$644 to downsize from an I-4 naturally-aspirated engine to a smaller displacement I-4 turbocharged engine, \$512 for a downsize from a V-6 naturally-aspirated engine to an I-4 turbocharged engine, and \$1,098 for a downsize from a V-8 naturally-aspirated engine to a V-6 turbocharged engine.

Phase-in caps have been modified from the MY 2011 final rule and are now limited to 85 percent per year with time-based learning applied. NHTSA considered the complexity of implementing this technology and determined that this technology can be applied at redesign only. There are no subclass specific limitations on its application.

Table V-18 Turbocharging and Downsizing and Other Camshaft Configuration Costs in 2016 (2007 dollars)

		Direct manufacturing costs in 2016								
	technology	incremental to	Turbo		cylinder # change at \$50/	Engine downsize costs		Resultant Downsize cost	IC Mark up	Compliance Cost*
			I3/I4	V6/V8		valve # change at \$10/	Cam # change at \$100/			
Turbo w/o downsize Downsize w/o turbo	Turbocharge (single)	Base engine	\$329	n/a	n/a	n/a	n/a	n/a	1.11	\$366
	Turbocharge (twin)	Base engine	n/a	\$598	n/a	n/a	n/a	n/a	1.11	\$663
	Downsize to I4 DOHC	V6 DOHC	n/a	n/a	-2	-8	-2	-\$379	1.11	-\$337
	Downsize to I4 DOHC	V6 SOHC	n/a	n/a	-2	+4	0	-\$60	1.11	-\$53
	Downsize to I4 DOHC	V6 OHV	n/a	n/a	-2	+4	+3	\$239	1.11	\$265
	Downsize to I4 DOHC	I4 DOHC (larger)	n/a	n/a	0	0	0	-\$53	1.11	-\$47
	Downsize to I3 DOHC	I4 DOHC	n/a	n/a	-1	-4	0	-\$90	1.11	-\$80
	Downsize to V6 DOHC	V8 DOHC	n/a	n/a	-2	-8	0	-\$179	1.11	-\$160
	Downsize to V6 DOHC	V8 SOHC 2V	n/a	n/a	-2	+8	+2	\$179	1.11	\$199
	Downsize to V6 DOHC	V8 SOHC 3V	n/a	n/a	+2	0	+2	\$299	1.11	\$332
	Downsize to V6 DOHC	V8 OHV	n/a	n/a	-2	+8	+3	\$279	1.11	\$310
	Downsize to I4 DOHC & add turbo	V6 DOHC w/o turbo	\$398	n/a	-2	-8	-2	-\$379	1.25	\$214
	Downsize to I4 DOHC & add turbo	V6 SOHC w/o turbo	\$398	n/a	-2	+4	0	-\$60	1.25	\$453
	Downsize to I4 DOHC & add turbo	V6 OHV w/o turbo	\$398	n/a	-2	+4	+3	\$239	1.25	\$797
Turbo with downsize	Downsize to I4 DOHC & add turbo	I4 DOHC (larger) w/o turbo	\$329	n/a	0	0	0	-\$53	1.25	\$372
	Downsize to I3 DOHC & add turbo	I4 DOHC w/o turbo	\$329	n/a	-1	-4	0	-\$90	1.25	\$344
	Downsize to V6 DOHC & add twin turbo	V8 DOHC w/o turbo	n/a	\$598	-2	-8	0	-\$179	1.25	\$613
	Downsize to V6 DOHC & add twin turbo	V8 SOHC 2V w/o turbo	n/a	\$598	-2	+8	+2	\$179	1.25	\$971
	Downsize to V6 DOHC & add twin turbo	V8 SOHC 3V w/o turbo	n/a	\$598	-2	0	+2	\$100	1.25	\$872
	Downsize to V6 DOHC & add twin turbo	V8 OHV w/o turbo	n/a	\$598	-2	+8	+3	\$279	1.25	\$1,096
Cam changes	Convert to V6 DOHC	V6 SOHC	n/a	n/a	0	+12	+2	\$319	1.11	\$354
	Convert to V6 DOHC	V6 OHV	n/a	n/a	0	+12	+3	\$418	1.11	\$464
	Convert to V8 DOHC	V8 SOHC 2V	n/a	n/a	0	+16	+2	\$359	1.11	\$398
	Convert to V8 DOHC	V8 SOHC 3V	n/a	n/a	0	+8	+2	\$279	1.11	\$310
	Convert to V8 DOHC	V8 OHV	n/a	n/a	0	+16	+3	\$419	1.11	\$509

* Note that, where downsizing results in cost savings, the compliance cost is calculated as the IC markup less 1 which is then multiplied by the absolute value of the direct manufacturing cost. The absolute value of the direct manufacturing cost is then subtracted from that to arrive at the end result. For example, for the V6 DOHC downsized to the I4 DOHC at a direct manufacturing cost of -\$379, the compliance cost would be $(1.11-1) \times |-\$379| - |-\$379| = -\$337$.

(10) Cooled Exhaust Gas Recirculation/EGR Boost (EGRB)

Cooled exhaust gas recirculation (cooled EGR) or EGR Boost is a combustion concept that involves utilizing EGR as a charge dilutant for controlling combustion temperatures and cooling the EGR prior to its introduction to the combustion system. Higher exhaust gas residual levels at part load conditions reduce pumping losses for increased fuel economy. Cooled EGR reduces knock sensitivity which enables the use of more optimal spark advance or enables compression ratio to be increased for improved thermal efficiency, and increased fuel economy. Currently available turbo, charge air cooler, and EGR cooler technologies are sufficient to demonstrate the feasibility of this concept.

However, this remains a technology with a number of issues that still need to be addressed and for which there is no production experience. EGR system fouling characteristics could be potentially worse than diesel EGR system fouling, due to the higher HC levels found in gasoline exhaust. Turbocharger compressor contamination may also be an issue for low pressure EGR systems. Additionally, transient controls of boost pressure, EGR rate, cam phasers and intake charge temperature to exploit the cooled EGR combustion concept will require development beyond what has already been accomplished by the automotive industry. These are all “implementation readiness” issues that must be resolved prior to putting EGR Boost into high volume production.

NHTSA has concluded that these implementation issues could be resolved and this technology could be brought to production by MY 2013. Supporting this conclusion, MEMA has previously suggested a 5 to 7 percent effectiveness for cooled EGR systems, although without boosting.¹³⁹ Two public sources indicate a 10 to 20 percent fuel consumption effectiveness for a downsized DI engine with cooled EGR compared to a naturally aspirated baseline engineⁱ and a 4 percent fuel consumption effectiveness for cooled EGR compared to a conventional downsized DI turbocharged engine.ⁱⁱ Based on the data from these reports, NHTSA estimates the incremental reduction in fuel consumption for EGR Boost to be 4 percent over a turbocharged and downsized DI engine. Thus, if TRBDS precedes EGRB, adding the 12 percent gain from TRBDS to the 4 percent gain from EGRB results in total fuel consumption reduction of 16 percent. This is in agreement with the range suggested in the Lotus report.

Regarding costs, the addition of EGR cooler and EGR valve were estimated in NHTSA’s MY 2011 rule to have an incremental RPE cost impact of approximately \$173 based on confidential individual component cost data from 2008 Martec describing EGR cooler costs of \$75, EGR valve costs of \$20 and associated piping costs of \$20, totaling \$115 (non-RPE). For purposes of this NPRM, NHTSA found no information to indicate that these estimates were inaccurate. To that end, NHTSA applied an indirect cost multiplier of 1.25, for a medium complexity technology, resulting in a compliance cost of \$144. However, given the lack of public data on this technology, the agencies seek comment on these assumptions.

¹³⁹ Docket No. NHTSA-2008-0089-0193.1

EGRB can be applied to all vehicle classes starting in MY 2013. Phase-in caps are limited to 85 percent per year with time-based learning applied. NHTSA considered the complexity of implementing this technology and determined that this technology can be applied at redesign only.

(11) Diesel Engine Technologies

Diesel engines have several characteristics that give them superior fuel efficiency compared to conventional gasoline, spark-ignited engines. Pumping losses are much lower due to lack of (or greatly reduced) throttling. The diesel combustion cycle operates at a higher compression ratio, with a very lean air/fuel mixture, and turbocharged light-duty diesels typically achieve much higher torque levels at lower engine speeds than equivalent-displacement naturally-aspirated gasoline engines. Additionally, diesel fuel has a higher energy content per gallon.¹⁴⁰

Diesel engines have emissions characteristics that present challenges to meeting federal Tier 2 NO_x emissions standards. It is a significant systems-engineering challenge to maintain the fuel consumption advantage of the diesel engine while meeting U.S. emissions regulations. Fuel consumption can be negatively impacted by emissions reduction strategies depending on the combination of strategies employed. Emission compliance strategies for diesel vehicles sold in the U.S. are expected to include a combination of combustion improvements and aftertreatment. These emission control strategies are being introduced on Tier 2 light-duty diesel vehicles today

To achieve U.S. Tier 2 emissions limits, roughly 45 to 65 percent more NO_x reduction is required compared to the Euro VI standards. Additionally, as discussed below, there may be a fuel consumption penalty associated with diesel aftertreatment since extra fuel is needed for the aftertreatment, and this extra fuel is not used in the combustion process of the engine that provides power to propel the vehicle.

Light-duty diesel emissions control systems capable of meeting Tier 2 Bin 5 emission standards are already in production. Several key advances in diesel technology have made it possible to reduce emissions coming from the engine prior to aftertreatment. These technologies include improved fuel systems (higher injection pressure and multiple-injection capability), advanced controls and sensors to optimize combustion and emissions performance, higher EGR levels and EGR cooling to reduce NO_x, and advanced turbocharging systems.

On the aftertreatment side, the traditional 3-way catalyst aftertreatment found on gasoline-powered vehicles is ineffective due to the lean-burn combustion of a diesel. All diesels will require a diesel particulate filter (DPF) or catalyzed diesel particulate filter (CDPF), a diesel oxidation catalyst (DOC), and a NO_x reduction strategy to comply with Tier 2 emissions standards. The most common NO_x reduction strategies include the use of lean NO_x traps (LNT) or selective catalytic reduction (SCR), which are outlined below.

Diesel Engine with Lean NO_x Trap (LNT) Catalyst After-Treatment

¹⁴⁰ Burning one gallon of diesel fuel produces about 15 percent more carbon dioxide than gasoline due to the higher density and carbon to hydrogen ratio.

A lean NO_x trap operates, in principle, by oxidizing NO to NO₂ in the exhaust and storing NO₂ on alkali sorbent material. When the control system determines (via mathematical model or a NO_x sensor) that the trap is saturated with NO_x, it switches the engine into a rich operating mode or may in some cases inject fuel directly into the exhaust stream to produce excess hydrocarbons that act as a reducing agent to convert the stored NO_x to N₂ and water, thereby “regenerating” the LNT and opening up more locations for NO_x to be stored. LNTs preferentially store sulfate compounds from the fuel, which can reduce catalytic performance. The system must undergo periodic desulfurization by operating at a net-fuel-rich condition at high temperatures in order to retain NO_x trapping efficiency.

NHTSA has concluded that the application of diesel engines on small vehicles is not a viable or cost effective option. NHTSA has also concluded that LNT-based diesel engines are best suited to smaller vehicle. Thus for purposes of this NPRM the application of LNT-based diesel engines has not been included and cost and effectiveness estimates were not generated.

Diesel Engine with Selective Catalytic Reduction (SCR) After-Treatment

An SCR aftertreatment system uses a reductant (typically, ammonia derived from urea) that is injected into the exhaust stream ahead of the SCR catalyst. Ammonia reacts with NO_x in the SCR catalyst to form N₂ and water. The hardware configuration for an SCR system is more complicated than that of an LNT, due to the onboard urea storage and delivery system (which requires a urea pump and injector to inject urea into the exhaust stream). While a rich engine-operating mode is not required for NO_x reduction, urea is typically injected at a rate of approximately 3 percent of the fuel consumed. Manufacturers designing SCR systems intend to align urea tank refills with standard maintenance practices such as oil changes. As is the case with LNT-based diesels, EPA and NHTSA project that SCR-based diesel engines will be available within the next couple of years. Mercedes-Benz recently introduced two 2009 model year vehicles R320 and GL320, both of which are certified to Tier 2, Bin 5 emission standards. Based on public announcements from several other companies, an increased number of product offerings from multiple companies are expected over the next few years.

In order to maintain equivalent performance to comparable gasoline-engine vehicles, an in-line 4-cylinder diesel engine, with displacement varying around 2.8 liters was assumed to replace a V6 gasoline base engine for Performance Compact, Performance Midsize, Large Passenger Car, Minivan, and Midsize Truck for the CAFE model. A V-6 diesel engine, with displacement varying around 4.0 liters to meet vehicle performance requirements, was assumed to replace a V8 gasoline base engine for Large Truck and Performance Large Car vehicle classes for the CAFE model. It was also assumed that diesel engines for these classes would utilize SCR aftertreatment systems. Confidential manufacturer and non-confidential comment data submitted in response to NHTSA’s past rulemaking for diesel engines showed a fuel consumption reduction in the range of 16.7 percent to 26.7 percent.

NHTSA’s MY 2011 CAFE final rule, which was supported by confidential manufacturer data, estimated the fuel consumption reduction of SCR-based diesel system to be between 20 to 25 percent over a baseline gasoline engine. This equates to a 5.3 to 6.9 percent improvement for DSLT, which is incremental to a turbocharged downsized

gasoline engine (TRBDS) with EGRB, and a 10.8 to 11.7 percent incremental improvement for DSLC, which is incremental to a gasoline engine with combustion restart (CBRST.) NHTSA has revisited these values and found them to be valid for this NRPM.

Diesel engines are more costly than port-injected spark-ignition gasoline engines. These higher costs result from:

- Fuel systems (higher pressures and more responsive injectors);
- Controls and sensors to optimize combustion and emissions performance;
- Engine design (higher cylinder pressures require a more robust engine, but higher torque output means diesel engines can have reduced displacement);
- Turbocharger(s);
- Aftertreatment systems, which tend to be more costly for diesels;

Due to a significant decrease in platinum group metal prices since NHTSA's MY 2011 CAFE final rule analysis, NHTSA in consultation with EPA chose to re-analyze diesel costs. In EPA's 2008 Staff Report, costs were considered for two types of diesel systems: one using a lean-NO_x trap (LNT) along with a diesel particulate filter (DPF); and one using a selective catalytic reduction (SCR) system along with a DPF. In that report, EPA estimated direct manufacturing costs to range from \$1,860 for the small car (LNT plus DPF) to \$2,710 for the large truck (SCR plus DPF). For comparison, the NESCCAF study showed direct manufacturing costs of \$1,500 to \$1,950. More recently, NHTSA's 2011 CAFE final rule showed direct manufacturing costs of \$2,670 for a 4-cylinder engine using a LNT plus DPF system, \$3,735 for a 6-cylinder engine using a SCR plus DPF system, and \$4,668 for an 8-cylinder engine using a SCR plus DPF system. NHTSA noted that estimates in the MY 2011 CAFE final rule were higher than those shown in the proposed rule due largely to the spike in platinum group metal prices that had occurred in the months just prior to issuing the final rule.

The following diesel costs were developed by EPA, drawing on their experience with diesel engine and aftertreatment systems. A breakdown of the cost estimates is shown in

Table V-19. These costs are generally lower than the MY 2011 CAFE final rule assumptions and were developed by taking a look back at EPA's 2008 Staff Report, which reveals a couple of factors that resulted in somewhat misleading costs. First, the engine costs estimated there did not take into account the downsizing that would occur when moving from a gasoline engine to a diesel engine (provided equivalent performance was maintained). Second, the engine costs used in that analysis were actually stated in terms of 2002 dollars rather than 2006 dollars in which the report was meant to be stated. EPA and NHTSA engineers decided that an update to the engine-related costs would provide a much better cost estimate for converting to diesel. This was done by starting with the source for engine costs in the 2008 staff report which was an October 2005 EPA Interim Reportⁱⁱⁱ which, in turn, sourced estimates from a 2003 study done by FEV for EPA contained within a 2004 EPA Interim Technical Report.^{iv} These direct manufacturing costs are reproduced in

Table V-19.

Table V-19 Diesel Engine Direct Manufacturing Source Costs, Incremental to a Baseline Gasoline Engine (2002 dollars)

Component(s)	Large SUV	Midsize
Gasoline engine (baseline)	5L V8	2.4L I4
Diesel engine	4L V8	2.2L I4
Add high-pressure, common rail diesel fuel injection system	\$980	\$630
Delete gasoline fuel injection system	-\$245	-\$165
Add variable geometry turbocharger	\$175	\$126
Delete gasoline ignition system	-\$120	-\$75
Delete fuel pump and other changes to fuel system	-\$94	-\$75
Enhance powertrain mounting system	\$87	\$107
Other engine changes	\$80	\$70
Add air intercooler, ducts, and sensor	\$80	\$55
Larger battery and starter, add glow plugs	\$72	\$50
Delete exhaust gas oxygen sensor*	-\$60	-\$30
Add supplemental heater	\$50	\$15
Modify transmission	\$25	\$25
Enhance sound insulation package	\$25	\$10
Smaller radiator	-\$13	-\$4
Total	\$1,042	\$739

Note: Table reproduced from EPA420-R-05-012, October 2005

Building on the direct manufacturing costs shown in

Table V-19, EPA and NHTSA engineers used appropriate scaling to estimate the costs for replacing a baseline gasoline engine with a diesel engine for the following four situations: a large car converted from a 4.5L V8 gasoline to a 3L V6 diesel; a medium/large MPV converted from a 3.2L V6 to a 2.8L I4 diesel; a small truck converted from a 3.2L V6 gasoline to a 2.8L I4 diesel; and a large truck converted from a 5.6L V8 gasoline to a 4L V6 diesel. A small car conversion was not considered since the diesel conversion for the small car was not considered to be a viable or cost effective option. The results for the four base gasoline to diesel conversions are shown in

Table V-20. Values from

Table V-19 have been updated to 2007 dollars using the GDP price deflator factor of 1.15 (see Appendix 3.A). Since the source costs were developed in 2003, this analysis conservatively considers the costs shown in

Table V-20 as being applicable to the 2012 model year.

Table V-20 Diesel Engine Direct Manufacturing Scaled-Costs in 2012, Incremental to Baseline Gasoline Engine (2007 dollars)

Component(s)	Large car	Med/large mpv	small truck	Large truck	notes (see text below)
Gasoline engine (baseline)	4.5L V8	3.2L V6	3.2L V6	5.6L V8	
Diesel engine	3L V6	2.8L I4	2.8L I4	4L V6	
Add high-pressure, common rail diesel fuel injection system	\$1,026	\$724	\$724	\$1,026	1
Delete gasoline fuel injection system	-\$89	-\$73	-\$73	-\$89	2
Add variable geometry turbocharger	\$173	\$145	\$145	\$201	3
Delete gasoline ignition system	-\$138	-\$112	-\$112	-\$138	4
Delete fuel pump and other changes to fuel system	-\$108	-\$86	-\$86	-\$108	5
Enhance powertrain mounting system	\$100	\$123	\$123	\$100	6
Other engine changes	\$86	\$80	\$80	\$86	7
Add air intercooler, ducts, and sensor	\$78	\$63	\$63	\$92	8
Larger battery and starter, add glow plugs	\$70	\$57	\$57	\$70	9
Delete exhaust gas oxygen sensor*	0	0	0	0	10
Add supplemental heater	\$37	\$17	\$17	\$57	11
Modify transmission	\$29	\$29	\$29	\$29	12
Enhance sound insulation package	\$20	\$11	\$11	\$29	13
Smaller radiator	-\$15	-\$10	-\$10	-\$15	14
Engine downsize credit	-\$185	-\$390	-\$390	-\$185	15
Total	\$1,085	\$580	\$580	\$1,156	

Note: Oxygen sensor removals are included in aftertreatment costs.

NOTES:

The costs shown in Table V-20 were scaled in the following ways:

1. Large car and large truck calculated as 75% of the cost of

Table V-19's large SUV and 25% of midsize car; medium/large MPV and small truck calculated as equal to

Table V-19's midsize car. Values converted to 2007 dollars using GDP factor of 1.15.

2. The estimates generated by FEV for eliminating the gasoline fuel injection systems were considerably larger than EPA & NHTSA believed was appropriate. Therefore, to remain conservative, these costs were estimated, in 2007 dollars as follows: large car and large truck were calculated using incremental costs of \$8/injector, \$20/fuel rail, and \$5 for a pressure damper or $\$8 \times 8 + \$20 + \$5 = \89 ; medium/large MPV and small truck were calculated using incremental costs of \$8/injector, \$20/fuel rail, and \$5 for a pressure damper or $\$8 \times 6 + \$20 + \$5 = \73 .
3. Large car calculated as the average of

Table V-19's large SUV and midsize car; medium/large MPV and small truck
calculated as equal to

Table V-19's midsize car, and large truck calculated as equal to

Table V-19's large SUV. Values converted to 2007 dollars using GDP factor of 1.15.

4. Medium/large MPV and small truck calculated as the average of

Table V-19's large SUV and midsize car; Large car and large truck calculated as equal to

Table V-19's large SUV. Values converted to 2007 dollars using GDP factor of 1.15.

5. Medium/large MPV and small truck calculated as equal to

Table V-19's midsize car; large car and large truck calculated as equal to

Table V-19's large SUV. Values converted to 2007 dollars using GDP factor of 1.15.

6. Medium/large MPV and small truck calculated as equal to

Table V-19's large SUV; Large car and large truck calculated as equal to

Table V-19's midsize car. Values converted to 2007 dollars using GDP factor of 1.15.

7. Medium/large MPV and small truck calculated as equal to

Table V-19's midsize car; large car and large truck calculated as the average large SUV and midsize car. Values converted to 2007 dollars using GDP factor of 1.15.

8. Medium/large MPV and small truck calculated as equal to midsize car; Large car and large truck calculated as the average of

Table V-19's large SUV and midsize car; Large truck calculated as equal to

Table V-19's large SUV. Values converted to 2007 dollars using GDP factor of 1.15.

9. Medium/large MPV and small truck calculated as equal to

Table V-19's midsize car; Large car and large truck calculated as the average of

Table V-19's large SUV and midsize car. Values converted to 2007 dollars using GDP factor of 1.15.

10. Medium/large MPV and small truck calculated as equal to

Table V-19's midsize car; Large car and large truck calculated as the average of

Table V-19's large SUV and midsize car. Values converted to 2007 dollars using GDP factor of 1.15.

11. Medium/large MPV and small truck calculated as equal to

Table V-19's midsize car; Large car and large truck calculated as the average of

Table V-19's large SUV and midsize car; Large truck calculated as equal to

Table V-19's large SUV. Values converted to 2007 dollars using GDP factor of 1.15.

12. Values converted to 2007 dollars using GDP factor of 1.15.

13. Medium/large MPV and small truck calculated as equal to

Table V-19's midsize car; Large car and large truck calculated as the average of

Table V-19's large SUV and midsize car; Large truck calculated as equal to

Table V-19's large SUV. Values converted to 2007 dollars using GDP factor of 1.15.

14. Medium/large MPV and small truck calculated as the average of

Table V-19's large SUV and midsize car; Large car and large truck calculated as equal to

Table V-19's large SUV. Values converted to 2007 dollars using GDP factor of 1.15.

15. Based on the approach presented in the turbocharging/downsizing section, the savings associated with downsizing the gasoline engine were calculated by estimating the cost in 2007 dollars of each cylinder at \$51, each valve at \$10, and each cam at \$103.

Therefore, the large car and large truck, which each lose two cylinders (-\$102), eight valves (-\$82) and no cams realize a \$185 savings. The medium/large MPV and small truck would each lose two cylinders (-\$102) and eight valves (-\$82) and two cams (-\$205) for a savings of \$390.

For the diesel aftertreatment systems, the approach taken is consistent with the approach taken in EPA's 2007/2010 Highway Diesel rule and EPA's recent locomotive and marine rule.¹⁴¹ For platinum group metal costs, monthly average prices as of March 2009 as reported by Johnson-Matthey were used.¹⁴² Those values were \$1,085/troy ounce for platinum and \$1,169/troy ounce for rhodium. Aftertreatment devices were sized according to the diesel engine displacement with a 1:1 ratio for both the SCR catalyst and the DPF, and a 0.5:1 ratio for the DOC (i.e., the DOC is half the displacement of the engine). The end result for aftertreatment devices, including a urea dosing unit, urea tank and necessary brackets and heaters, are shown in Table V-21. Also shown in Table V-21 are the savings associated with removal of the gasoline catalyst. Note that the gasoline catalyst was sized according to the gasoline engine that served as the baseline engine.

Table V-21 Diesel Aftertreatment Direct Manufacturing Costs in 2012 (2007 dollars)

Component(s)	Large car	Med/large mpv	Small truck	large truck
Gasoline engine (baseline)	4.5L V8	3.2L V6	3.2L V6	5.6L V8
Diesel engine	3L V6	2.8L I4	2.8L I4	4L V6
DOC	\$277	\$257	\$257	\$339
DPF (includes a \$20 pressure sensor for OBD & sensing)	\$534	\$503	\$503	\$668
SCR system (includes a \$50 NO _x sensor for OBD & sensing)	\$904	\$904	\$914	\$996
Removal of gasoline catalysts & sensors	-\$401	-\$288	-\$298	-\$483
Total	\$1,314	\$1,376	\$1,376	\$1,520

The incremental costs to convert from a gasoline to a diesel engine—

¹⁴¹ EPA's 2007/2010 diesel heavy-duty highway final rule at 66 FR 5002; EPA's Locomotive and Marine final rule at 73 FR 37096.

¹⁴² <http://www.platinum.matthey.com>

Table V-20 and Table V-21 combined—are shown in

Table V-22.

Table V-22 Direct Manufacturing Costs to Convert from a Gasoline to Diesel System in 2012 (2007 dollars)

Component(s)	Large car	Med/large mpv	small truck	large truck
Gasoline engine (baseline)	4.5L V8	3.2L V6	3.2L V6	5.6L V8
Diesel engine	3L V6	2.8L I4	2.8L I4	4L V6
Engine-related costs	\$1,085	\$580	\$580	\$1,156
Aftertreatment	\$1,314	\$1,376	\$1,376	\$1,520
Total	\$2,399	\$1,956	\$1,956	\$2,676

This analysis applies time-based learning to diesel systems and a medium complexity rating of 1.25. Therefore, the MY 2012 compliance costs are as shown in Table V-23.

Table V-23 Compliance Costs to Convert from a Gasoline to Diesel System in 2012 (2007 dollars)

Component(s)	Large car	Med/large mpv	small truck	large truck
Gasoline engine (baseline)	4.5L V8	3.2L V6	3.2L V6	5.6L V8
Diesel engine	3L V6	2.8L I4	2.8L I4	4L V6
Total	\$2,999	\$2,445	\$2,445	\$3,345

Given the above analysis, NHTSA estimated that the compliance cost of converting a V6 gasoline engine to an I4 diesel engine was \$2445 for MY 2012. This results in an incremental compliance cost of \$916 to \$971 for DSLT and \$1,572 to \$1,627 for DSLC. A MY 2012 cost of \$3345 was estimated for converting a V8 gasoline engine to a V6 diesel engine. This results in an incremental compliance cost of \$1,090 to \$1,145 for DSLT and \$2,331 to \$2,387 for DSLC. These compliance costs include the medium complexity ICM markup of 1.25

The diesel engine technology can be applied to all vehicle classes except those for which an inline 4-cylinder is assumed. Diesel engines can only be applied at redesign with time-based learning. NHTSA assumed a 3 percent phase-in cap for diesels in MY2012 and increasing 3 percent per year reaching a maximum of 15 percent in MY 2016.

b. Transmission Technologies

NHTSA has reviewed the transmission technology estimates used in the MY 2011 CAFE final rule and considered or reconsidered all available sources and updated the estimates as appropriate. The section below describes each of the transmission technologies considered for this rulemaking.

**(12) Improved Automatic Transmission Control (IATC)
(Aggressive Shift Logic and Early Torque Converter Lockup)**

Calibrating the transmission shift schedule to upshift earlier and quicker, and to lock-up or partially lock-up the torque converter under a broader range of operating conditions can reduce fuel consumption. However, this operation can result in a perceptible degradation in noise, vibration, and harshness (NVH). The degree to which NVH can be degraded before it becomes noticeable to the driver is strongly influenced by characteristics of the vehicle, and although it is somewhat subjective, it always places a limit on how much fuel consumption can be improved by transmission control changes. Given that the Aggressive Shift Logic and Early Torque Converter Lockup are best optimized simultaneously due to the fact that adding both of them primarily requires only minor modifications to the transmission or calibration software, these two technologies are combined in the modeling.

(13) Aggressive Shift Logic

During operation, an automatic transmission's controller manages the operation of the transmission by scheduling the upshift or downshift, and locking or allowing the torque converter to slip based on a preprogrammed shift schedule. The shift schedule contains a number of lookup table functions, which define the shift points and torque converter lockup based on vehicle speed, throttle position, and other parameters such as temperature. Aggressive shift logic (ASL) can be employed in such a way as to maximize fuel efficiency by modifying the shift schedule to upshift earlier and inhibit downshifts under some conditions, which reduces engine pumping losses and engine friction. The application of this technology does require a manufacturer to confirm that drivability, durability, and NVH are not significantly degraded.

(14) Early Torque Converter Lockup

A torque converter is a fluid coupling located between the engine and transmission in vehicles with automatic transmissions and continuously-variable transmissions (CVT). This fluid coupling allows for slip so the engine can run while the vehicle is idling in gear (as at a stop light), provides for smoothness of the powertrain, and also provides for torque multiplication during acceleration, and especially launch. During light acceleration and cruising, the inherent slip in a torque converter causes increased fuel consumption, so modern automatic transmissions utilize a clutch in the torque converter to lock it and prevent this slippage. Fuel consumption can be further reduced by locking up the torque converter at lower vehicle speeds, provided there is sufficient power to propel the vehicle, and noise and vibration are not excessive.¹⁴³ If the torque converter cannot be fully locked up for maximum efficiency, a partial lockup strategy can be employed to reduce slippage. Early torque converter lockup is applicable to all vehicle types with automatic transmissions. Some torque converters will require upgraded clutch materials to withstand additional loading and the slipping conditions during partial lock-up. As with aggressive shift logic, confirmation of acceptable

¹⁴³ Very aggressive early torque converter lock up may require an adjustment to damper stiffness and hysteresis inside the torque converter.

drivability, performance, durability and NVH characteristics is required to successfully implement this technology.

Regarding the effectiveness of Improved Automatic Transmission Control, the MY2011 CAFE final rule, which was supported by the 2002 NAS and NESCCAF reports as well as confidential manufacturer data, estimated an effectiveness improvement of 1 to 2 percent for aggressive shift logic and 0.5 percent for early torque converter lockup. These estimates are in agreement with the values stated in the NESCCAF report and confidential manufacturer data. For the purpose of this NPRM, NHTSA concluded that the combined estimated effectiveness is 1.5 to 2.5% reduction in fuel consumption.

For a cost estimate, and for a MY 2012 vehicle, NHTSA updated the MY 2011 CAFE final rule estimate of \$59 with a 1.5 RPE to \$60 with a low complexity ICM markups value of 1.11. This reflects a revisiting of component costs for the early torque converter lock-up technology which potentially involves hardware changes. Time based learning methods are applied so subsequent MY costs are lower. Given the relative ease of implementation, from a manufacturing perspective, the Volpe model can apply IATC at either the refresh or redesign product cycle, and there are no subclass specific limitations on its application other than that the baseline vehicle must be equipped with an automatic transmission. Phase-in caps in this proposal are set at 85 percent for MYs 2012 to 2014 and 100 percent for the remaining years of the rulemaking.

**(15) Automatic 6-, 7- and 8-Speed Transmissions
(NAUTO)**

Manufacturers can also choose to replace 4- and 5-speed transmission with 6-, 7-, or 8-speed automatic transmissions. Additional ratios allow for further optimization of engine operation over a wider range of conditions, but this is subject to diminishing returns as the number of speeds increases. As additional planetary gear sets are added (which may be necessary in some cases to achieve the higher number of ratios), additional weight and friction are introduced. Also, the additional shifting of such a transmission can be perceived as bothersome to some consumers, so manufacturers need to develop strategies to minimize the impact of additional shifts. Some manufacturers are replacing 4- and 5-speed automatics with 6-speed automatics, and 7- and 8-speed automatics have also entered production, albeit in lower-volume applications in luxury and performance oriented cars.

As discussed in the MY 2011 CAFE final rule, confidential manufacturer data projected that 6-speed transmissions could incrementally reduce fuel consumption by 0 to 5 percent from a baseline 4-speed automatic transmission, while an 8-speed transmission could incrementally reduce fuel consumption by up to 6 percent from a baseline 4-speed automatic transmission. The 2008 Martec report estimated a cost of \$323 (RPE adjusted) for converting a 4-speed to a 6-speed transmission and a cost of \$638 (RPE adjusted) for converting a 4-speed to an 8-speed transmission. GM has publicly claimed a fuel economy improvement of up to 4 percent for its new 6-speed automatic transmissions. The 2008 EPA Staff Technical Report found a 4.5 to 6.5 percent fuel consumption

improvement for a 6-speed over a 4-speed automatic transmission.¹⁴⁴ Based on this information, NHTSA estimated in the MY 2011 rule, that the conversion to a 6-, 7- and 8-speed transmission (NAUTO) from a 4- or 5-speed automatic transmission with IATC would have an incremental fuel consumption benefit of 1.4 percent to 3.4 percent, for all vehicle classes. From a baseline 4 or 5 speed transmission without IATC, the incremental fuel consumption benefit would be approximately 3 to 6 percent. NHTSA reviewed these effectiveness estimates and concluded that they remain accurate.

NHTSA reviewed the cost estimates from the MY 2011 CAFE final rule and concluded that some 6-speed automatic transmissions would be equipped with Lepelletier gear set, and as such, the estimates were revised to establish the cost for the 6-speed transmission to be equally divided between application using Lepelletier, and application of a standard planetary gear set 6-speed automatic transmission as estimated in the 2008 Martec report. As a result, the final incremental cost estimate for this proposal is \$170, for the non-performance passenger car and Small LT subclasses; this incorporates a low complexity 1.11 ICM markup factor. An additional \$102 is included in the upper cost estimate to account for performance vehicle classes and for Midsize and Large LT classes. This is because for the performance vehicle subclasses, additional gear ratios, such as 7- and 8-speed transmissions may be utilized, and for medium and large trucks heavier duty transmissions may be required for utility purposes. These estimates represent MY 2012 vehicle costs; MY 2016 costs would be lower due to the application of time based learning factors. Incorporation of new transmissions into existing vehicles often involves significant vehicle revision or redesign therefore the NAUTO technology is only applied by the Volpe model at redesign product cycle. For this proposal, a phase-in of 85 percent is set for MY 2012 followed by 100 percent for all others. NAUTO is only applied to vehicles that have a baseline planetary automatic transmission meaning that manual transmission vehicles are not converted to automatics as a result of the modeling process (i.e., they are preserved, as are CVTs).

(16) Dual Clutch Transmissions / Automated Manual Transmissions (DCTAM)

An Automated Manual Transmission (AMT) is mechanically similar to a conventional manual transmission, but shifting and launch functions are automatically controlled by the electronics. There are two basic types of AMTs, single-clutch and dual-clutch (DCT). A single-clutch AMT is essentially a manual transmission with automated clutch and shifting. Because of shift quality issues with single-clutch designs, DCTs will likely be far more common in the U.S. and are the basis of the estimates that follow. A DCT uses separate clutches (and separate gear shafts) for the even-numbered gears and odd-numbered gears. In this way, the next expected gear is pre-selected which allows for faster and smoother shifting. For example, if the vehicle is accelerating in third gear, the shaft with gears one, three and five has gear three engaged and is transmitting power. The shaft with gears two, four, and six is idle, but has gear four pre-selected. When a shift is required, the controller disengages the odd-gear clutch while simultaneously

¹⁴⁴ Page 17, “EPA Staff Technical Report: Cost and Effectiveness Estimates of Technologies Used to Reduce Light-duty Vehicle Carbon Dioxide Emissions” Environmental Protection Agency, EPA420-R-08-008, March 2008.

engaging the even-gear clutch, thus making a smooth shift. If, on the other hand, the driver slows down instead of continuing to accelerate, the transmission will have to change to second gear on the idling shaft to anticipate a downshift. This shift can be made quickly on the idling shaft since there is no torque being transferred on it.

In addition to single-clutch and dual-clutch AMTs, there are also wet clutch and dry clutch designs which are used for different types of vehicle applications. Wet clutch AMTs offer a higher torque capacity that comes from the use of a hydraulic system that cools the clutches. Wet clutch systems are less efficient than the dry clutch systems due to the losses associated with hydraulic pumping. Additionally, wet AMTs have a higher cost due to the additional hydraulic hardware required.

Overall, DCTs likely offer the greatest potential for effectiveness improvements among the various transmission options presented in this report because they offer the inherently lower losses of a manual transmission with the efficiency and shift quality advantages of electronic controls. The lower losses stem from the elimination of the conventional torque converter, and a greatly reduced need for high pressure hydraulic circuits to hold clutches or bands to maintain gear ratios (in automatic transmissions) or hold pulleys in position to maintain gear ratio (in Continuously Variable Transmissions). However, the lack of a torque converter will affect how the vehicle launches from rest, so a DCT will most likely be paired with an engine that offers sufficient torque at low engine speeds to allow for adequate launch performance.

For the MY 2011 CAFE final rule, NHTSA estimated a 5.5 to 9.7 percent improvement in fuel consumption over a baseline 4/5-speed automatic transmission for a wet clutch DCT, which was assumed for all but the smallest of vehicle subclasses, Subcompact and Compact cars. This results in an incremental effectiveness estimate of 2.7 to 4.1 percent over a 6-speed automatic transmission with IATC. For Subcompact, Compact Cars and Small light truck subclasses, which were assumed to use a dry clutch DCT, NHTSA estimated an 8.2 to 12.9 percent fuel consumption improvement over a baseline 4/5-speed automatic transmission, which equates to a 5.5 to 7.5 percent incremental improvement over the 6-speed transmission. NHTSA has retained these estimates for this proposal.

In the 2011 final rule, and relative to the prior technology NAUTO, NHTSA estimated incremental compliance costs of applying a dry DCT at \$68 and a wet DCT at \$218 in MY 2012. These estimates reflected the 1.5 RPE markups (therefore the direct costs for dry and wet DCT were \$45 and \$145 respectively).¹⁴⁵ For this proposal, and based on work conducted jointly with EPA during its development, NHTSA established incremental compliance costs of \$73 and \$158 for a dry and wet DCT respectively, and again incremental to NAUTO and for MY 2012 vehicles. These estimates are based on an ICM markup for a medium complexity technology of 1.26 (the direct costs are \$58 and \$125). Considering changes in the markup methods the net impact of these cost revisions, in terms of the overall costs of compliance, are relatively small. Time based

¹⁴⁵ In the 2011 final rule, the wet DCT costs on performance and truck subclasses was actually lower (\$61 at 1.5 RPE) due to the higher costs associated with the NAUTO technology for these subclasses.

learning is considered applicable to DCTs, so costs will be lower for each successive model year. For the same reasons as noted from the NAUTO technology, the Volpe model only applies DCTAM at redesign cycle at a phase-in rate of 85 percent in MY 2012, and 100 percent for the remaining years.

(17) Continuously Variable Transmission (CVT)

A Continuously Variable Transmission (CVT) is unique in that it does not use gears to provide ratios for operation. Instead, the most common CVT design uses two V-shaped pulleys connected by a metal belt. Each pulley is split in half and a hydraulic actuator moves the pulley halves together or apart. This causes the belt to ride on either a larger or smaller diameter section of the pulley which changes the effective ratio of the input to the output shafts. Advantages of the CVT are that the engine can operate at its most efficient speed-load point more of the time, since there are no fixed ratios. However, CVTs are limited by engine power and cannot be applied to high torque applications. Also, CVTs often have a wider range of ratios compared to conventional automatic transmissions which can provide more options for engine optimization. While CVTs by definition are fully continuous, some automakers choose to emulate conventional stepped automatic operation because some drivers are not used to the sensation of the engine speed operating independently of vehicle speed.

Considering the confidential data together with independent review, NHTSA has estimated the fuel consumption effectiveness for CVTs at 2.2 to 4.5 percent over a 4/5-speed automatic transmission, which translates into a 0.7 to 2.0 incremental effectiveness improvement over a planetary automatic transmission with the IATC technology. NHTSA continues to find these estimates to be accurate.

NHTSA adjusted the original estimates used in MY 2011 CAFE final rule to account for ICM markup of 1.25 for a medium technology. For this proposal, this results in an incremental compliance cost estimate of \$250 for the MY 2012 vehicles. In the Volpe model, this technology was only applied to vehicles manufactured with unibody construction methods, since ladder frame vehicles are typically unsuitable for CVTs due to their size and utility requirements. CVTs are an established and readily available technology so time based learning is applied, and as with other transmission technologies that result in new installations, CVT are only applied by the Volpe model at redesign cycle timing. The phase-in caps are now at 85 percent throughout the rulemaking period.

(18) 6-Speed Manual Transmissions (6MAN)

Manual transmissions are entirely dependent upon driver input to shift gears: the driver selects when to perform the shift and which gear to select. This is the most efficient transfer of energy of all transmission layouts, because it has the lowest internal gear losses, with a minimal hydraulic system, and the driver provides the energy to actuate the clutch. From a systems viewpoint, however, vehicles with manual transmissions have the drawback that the driver may not always select the optimum gear ratio for fuel economy. Nonetheless, increasing the number of available ratios in a manual transmission can improve fuel economy by allowing the driver to select a ratio

that optimizes engine operation more often. Typically, this is achieved through adding overdrive ratios to reduce engine speed at cruising velocities (which saves fuel through reduced engine pumping losses) and pushing the torque required of the engine towards the optimum level. However, if the gear ratio steps are not properly designed, this may require the driver to change gears more often in city driving resulting in customer dissatisfaction. Additionally, if gear ratios are selected to achieve improved launch performance instead of to improve fuel economy, no fuel saving effectiveness is realized.

NHTSA's MY 2011 CAFE final rule estimated an effectiveness increase of 0.5 percent for replacing a 5-speed manual with a 6-speed manual transmission, which was derived from confidential manufacturer data. NHTSA has found no evidence to dispute this estimate and chosen to use 0.5 percent reduction in fuel consumption for replacing a 5-speed manual with a 6-speed manual transmission for this proposal. NHTSA updated the 2011 final rule costs to reflect the ICM low complexity markup of 1.11 which resulted in an incremental compliance cost of \$250 for MY 2012 vehicles, as compared to \$338 in the final rule, with lower costs occurring in later MYs due to the application of time based learning factors. 6MAN is only applied to vehicles that use a manual transmission in the baseline product, and the Volpe model can only apply the technology at redesign cycle timing. The phase-in rate has been set to 85 percent for MY 2012 to 2014 and 100 percent for the remaining years of this proposal.

c. Hybrid and Electrification/Accessory Technologies

A Hybrid is a vehicle that combines two or more sources of propulsion energy, where one uses a consumable fuel (like gasoline), and one is rechargeable (during operation, or by another energy source). Hybrid technology is established in the U.S. market and more manufacturers are adding hybrid models to their lineups. Hybrids reduce fuel consumption through three major mechanisms:

- The internal combustion engine can be optimized (through downsizing, modifying the operating cycle, or other control techniques) to operate at or near its most efficient point more of the time. Power loss from engine downsizing can be mitigated by employing power assist from the secondary power source.
- Some of the energy normally lost as heat while braking can be captured and stored in the energy storage system for later use.
- The engine is turned off when it is not needed, such as when the vehicle is coasting or when stopped.

Hybrid vehicles utilize some combination of the three above mechanisms to reduce fuel consumption. A fourth mechanism to reduce petroleum fuel consumption, available only to plug-in hybrids, is by substituting the petroleum fuel energy with energy from another source, such as the electric grid. The effectiveness of fuel consumption reduction depends on the utilization of the above mechanisms and how aggressively they are pursued. One area where this variation is particularly prevalent is in the choice of

engine size and its effect on balancing fuel economy and performance. Some manufacturers choose not to downsize the engine when applying hybrid technologies. In these cases, performance is vastly improved, while fuel efficiency improves significantly less than if the engine was downsized to maintain the same performance as the conventional version. While this approach has been used in cars such as the Honda Accord Hybrid (now discontinued), it is more likely to be used for vehicles like trucks where towing and/or hauling is an integral part of their performance requirements. In these cases, the battery can be quickly drained during a long hill climb with a heavy load, leaving only a downsized engine to carry the entire load. Because towing capability is currently a heavily-marketed truck attribute, manufacturers are hesitant to offer a vehicle with significantly diminished towing performance with a low battery.

Although hybrid vehicles using other energy storage concepts (flywheel, hydraulic) have been developed, the systems currently in production in the U.S. for passenger cars and light trucks use battery storage and electric drive systems. Hybrid electric vehicles (HEV) are part of a continuum of vehicles using systems with differing levels of electric drive and electric energy storage. This range of vehicles includes relatively basic engine start/stop systems, HEV systems with varying degrees of electric storage and electric drive system capability, plug-in hybrid electric vehicles (PHEV) with differing degrees of all electric range and battery electric vehicles (EV) that rely entirely on electric drive and battery electric energy storage.

Different HEV, PHEV and EV concepts utilize these mechanisms differently, so they are treated separately for the purposes of this analysis. Below is a discussion of battery energy storage and the major hybrid concepts that were determined to be available in the near term.

i. Batteries for HEV, PHEV and EV Applications

The design of battery secondary cells can vary considerably between HEV, PHEV and EV applications.

MHEV systems will likely continue to use lead-acid batteries due to their lower voltage (12-42 VDC) and relatively low power and energy requirements. However, technology used is expected to be upgraded over conventional (non-MHEV) lead acid batteries to meet the charge cycling demands of MHEV applications, and is likely to include extended-cycle-life flooded (ELF) lead-acid batteries or absorptive glass matt, valve-regulated lead-acid (AGM/VRLA) batteries.

HEV applications operate in a narrow, short-cycling, charge-sustaining state of charge (SOC). Energy capacity in HEV applications is somewhat limited by the ability of the battery and power electronics to accept charge and by space and weight constraints within the vehicle design. HEV battery designs tend to be optimized for high power density rather than high energy density, with thinner cathode and anode layers and more numerous current collectors and separators (Figure V-12).

EV batteries tend to be optimized for high energy density and are considerably larger than HEV batteries. PHEV battery designs are intermediate between power-optimized HEV and energy-optimized EV battery cell designs. PHEV batteries also must provide both charge depleting operation similar to an EV and charge sustaining operation similar to an HEV. Unlike HEV applications, charge sustaining operation with PHEVs

occurs at a relatively low battery state of charge (SOC) which can pose a significant challenge with respect to attaining acceptable battery cycle life. In the case of the GM Volt, this limits charge depleting operation to a minimum SOC of approximately 30%.¹⁴⁶

Figure V-12 Schematic representation of power and energy optimized prismatic-layered battery cells

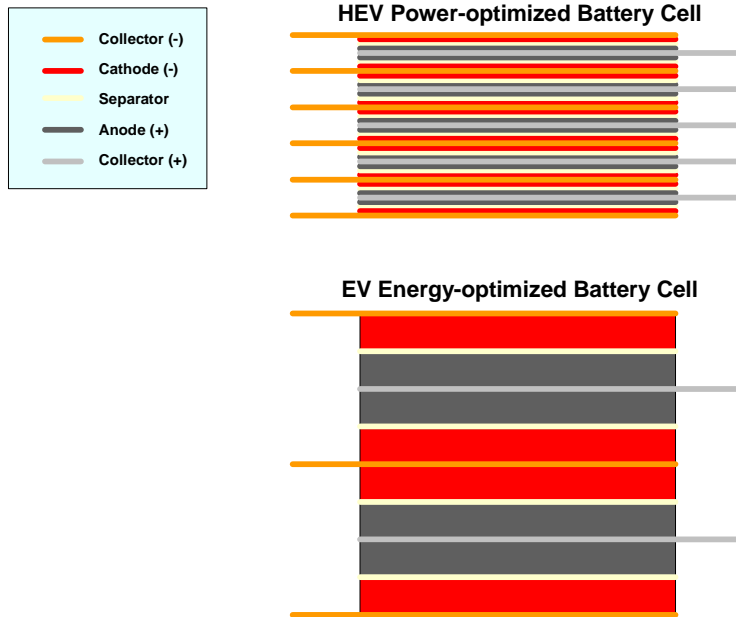

Power-split hybrid vehicles from Toyota, Ford and Nissan, integrated motor assist hybrid vehicles from Honda and the GM 2-mode hybrid vehicles currently use nickel-metal hydride (NiMH) batteries. Lithium-ion (Li-ion) batteries offer the potential to approximately double both the energy and power density relative to current NiMH batteries, enabling much more electrical-energy-intensive automotive applications such as PHEVs and EVs. Li-ion batteries for high-volume automotive applications differ substantially from those used in consumer electronics applications with respect to cathode chemistry, construction and cell size. Li-ion battery designs currently under development by CPI (LG-Chem) for the GM Volt PHEV and by AESC, GS-Yuasa and A123 Systems (respectively) for the upcoming Nissan, Mitsubishi and Chrysler EVs use large-format, layered-prismatic cells assembled into battery modules. The modules are then combined into battery packs.

¹⁴⁶ "Latest Chevrolet Volt Battery Pack and Generator Details and Clarifications." Lyle Dennis interview of Rob Peterson (GM) regarding the all-electric drive range of the GM Volt, August 29, 2007. Accessed on the Internet on June 30, 2009 at: <http://gm-volt.com/2007/08/29/latest-Chevrolet-volt-battery-pack-and-generator-details-and-clarifications/>

Cathodes for large-format, automotive Li-ion batteries are becoming increasingly focused on two chemistries – LiMn₂O₄-spinel (CPI, GS-Yuasa, AESC) and LiFePO₄ (A123 Systems).

In addition to the purely hybrid technologies, which decrease the proportion of propulsion energy coming from the fuel by increasing the proportion of that energy coming from electricity, there are other steps that can be taken to improve the efficiency of auxiliary functions (*e.g.*, power-assisted steering or air-conditioning) which also reduce fuel consumption. These steps, together with the hybrid technologies, are collectively referred to as “vehicle electrification” because they generally use electricity instead of engine power. In order to achieve consistency between the two modeling techniques, and to improve the number and range of technology offerings, the CAFE model was revised to include one additional mild hybrid technology. The high voltage or improved efficiency alternator (HVIA) technology, which was used in the 2011 rule, is no longer represented as a separate technology and has instead been incorporated into this new mild hybrid technology, as discussed further below.

ii. Hybrid System Sizing and Cost Estimating Methodology

NHTSA, in coordination with EPA reviewed estimates of cost and effectiveness for hybrid and related electrical technologies and adjusted them as appropriate. Both agencies found the hybrid technology cost estimating methodology that Ricardo and NHTSA developed during the 2011 final rule to be reasonable and used it to estimate hybrid systems costs and account for variation in component sizing across both the hybrid types and vehicle subclasses. That method utilizes four pieces of data: (1) key component sizes for a midsize car by hybrid system type; (2) normalized costs for each key component; (3) component scaling factors that are applied to each vehicle class/subclass by hybrid system type; and (4) vehicle characteristics for the subclasses which are used as the basis for the scaling factors. During development of the methodology, NHTSA and Ricardo made several assumptions:

- 1) Hybrid controls hardware varies with the level of functionality offered by the hybrid technology. Assumed hybrid controls complexity for a 12V micro hybrid (MHEV) and belt integrated starter generator (BISG) was 25 percent of a strong hybrid controls system and the complexity for a Crank Integrated Starter Generator (CISG) was 50 percent. These ratios were estimates based on the directional need for increased functionality as system complexity increases.
- 2) Li-Ion batteries for hybrid electric vehicles are currently entering production, including a 2010 MY Mercedes and Hyundai. One estimate from Anderman indicates that Li-ion market penetration will achieve 35 percent by 2015.¹⁴⁷ However, as was discussed above, significant development effort is underway by a number of battery producers which could impact cost and overcome other technical concerns. Therefore it was assumed that mild (MHEV, BISG and CISG) and strong hybrids (PSHEV, 2MHEV and PHEV) will use either Li-Ion or NiMH batteries, depending on cost considerations. However, plug-in

¹⁴⁷ Anderman, Advanced Automotive Battery Conference, May 2008. Proceedings available for purchase at <http://www.advancedautobat.com/Proceedings/index.html> (last accessed October 17, 2008).

hybrids will use Li-ion batteries only. Battery usage is discussed further below.

- 3) The plug-in hybrid battery pack was sized for a mid-sized car by assuming: the vehicle has a 20 mile all electric range and consumes an average of 300 W-hr per mile; the battery pack can be discharged down to 30 percent depth of discharge;¹⁴⁸ and the capacity of a new battery pack is 20 percent greater than at end of life (*i.e.*, range on a new battery pack is 24 miles).
- 4) All hybrid systems included a DC/DC converter which was sized to accommodate vehicle electrical loads appropriate for increased vehicle electrification in the time frame considered.
- 5) High voltage wiring scaled with hybrid vehicle functionality and could be represented as a fraction of strong hybrid wiring. These ratios were estimates based on the directional need for increased functionality as system complexity increases.
- 6) All hybrid systems included a supplemental heater to provide vehicle heating when the engine is stopped; however, in this proposal, it is assumed that only half of the vehicles will adapt this technology, as discussed further below. Only the strong hybrids included electric air conditioning to enable engine stop/start when vehicle air conditioning was requested by the operator.

Furthermore, NHTSA and Ricardo recognized that some strong hybrid systems replaced a conventional transmission with a hybrid-specific transmission, resulting in a cost offset (*i.e.*, a cost credit) for the removal of a portion of the clutches and gear sets within the transmission. In the MY 2011 rule, the transmission cost in Table V-24 below expressed hybrid transmission costs as a percentage of traditional automatic transmission cost, as described in the 2008 Martec Report, at \$850 direct manufacturing cost (non-RPE/ICM). The method assumed that the mechanical aspect of a power-split transmission with a reduced number of gear sets and clutches resulted in a cost savings of 50 percent (\$425) over a conventional transmission with torque converter. For a 2-mode hybrid, the mechanical aspects of the transmission are similar in complexity to a conventional transmission, so no cost savings was appropriate. The plug-in hybrid assumed a highly simplified transmission for electric motor drive, thus 25 percent of the base vehicle transmission cost was applied (resulting in a \$638 credit).

The NHTSA MY 2011 CAFE final rule discusses in detail how the hybrid cost estimating methodology uses the information provided in the tables below to calculate costs for each of the strong hybrid systems used in this proposal. It also includes a step-by-step example for the midsize vehicle mild hybrid systems used in the MY 2011 CAFE final rule.¹⁴⁹ As in that analysis, it is important to understand that the CISG technology replaces existing mild hybrid systems.¹⁵⁰

NHTSA and EPA in reviewing the above made the following revisions.

¹⁴⁸ The GM Volt operates between 30% DOD and 85% DOD. So there is 55% useable DOD, but charge sustaining operation starts at 30% and cycles between 30 and 35% DOD.

¹⁴⁹ 74 FR 14291 (Mar. 30, 2009)

¹⁵⁰ For the incremental CAFE model, before CISG is applied, the costs for MHEV and BISG are subtracted if they were previously applied.

First, NHTSA and EPA revalidated the component sizes that were estimated for a midsize car for each type of hybrid system as shown in Table V-24. However, NHTSA and EPA added an additional component-- front engine accessory drive (FEAD), because hybridization often involves revision to the FEAD design such that certain devices (belts, pulleys, idlers, etc) as well as other engine components (alternator, A/C compressor, and starter) may no longer be needed and can thus be eliminated, or may be de-specified to lower cost alternatives. This is applicable to CISG and the strong hybrid technologies, and is intended to account for cost savings associated with items that changed or are no longer required as a result of these technology applications.

Table V-24 Component Sizes by Hybrid Type for a Midsize Car

Component	Hybrid Type				
	MHEV BISG	CISG	PSHEV	2MHEV	PHEV
Primary Motor power, continuous (kW)	3	11	45	45	45
Secondary Motor power, continuous (kW)	na	na	30	45	30
Primary Inverter power, continuous (kW)	3	11	45	45	45
Secondary Inverter power, continuous (kW)	na	na	30	45	30
Controls complexity (relative to strong hybrid)	25%	50%	100%	100%	100%
NiMH Battery Pack capacity (kW-hr) ¹	na	1	2	2	na
Li-Ion Battery Pack capacity (kW-hr) ¹	na	1	2	2	15
DC/DC Converter power (kW)	0.7	2	2	2	2
High Voltage Wiring (relative to strong hybrid)	na	50%	100%	100%	100%
Supplemental heating ²	50%	50%	50%	50%	50%
Mechanical Transmission (relative to baseline vehicle)	100%	100%	50%	100%	25%
Electric AC	No	No	Yes	Yes	Yes
Blended Brakes	No	Yes	Yes	Yes	Yes
FEAD Credit	No	Yes	Yes	Yes	Yes
Charger power, continuous (kW)	na	na	na	na	3
1 - Assumes the use of either NiMH or Li-Ion, and not both.					
2 - Implemented through a reduction in component cost (50%)					

Second, the costs estimates of the key components were revised. The MY 2011 CAFE final rule was developed at a time when economic conditions were significantly different than those that currently exist, a time when many of the commodity materials used in the hybrid systems were more expensive than today. These changes in economic conditions were one of the factors leading to some of the cost revisions EPA and NHTSA jointly discussed and made. Differences in estimates provided by confidential sources to either EPA or NHTSA also played a part in the revisions. In addition, the agencies applied the new ICM mark-up factors instead of the RPE that was used previously. An appropriate ICM factor (1.45 for most mild and strong hybrid technologies) replaces the previous RPE factor (1.5). Specifically, the primary and secondary inverter cost per kilowatt were revised downward from \$10 to \$7, the controls cost was revised upward from \$100 to \$115, the DC/DC converter costs were revised from \$100 to \$88, the blended brake system that was revised from \$400 to \$310, and finally the fully learned, high volume production, cost per kilowatt hour (kW-hr) for Nickel Metal Hydride (NiMH) battery was revised from \$350 to \$320.

The cost for Lithium Ion (Li-Ion) batteries was also revised. As previously stated, Li-Ion batteries are being implemented in series production in model year 2010. Battery technology is changing rapidly in the marketplace today, as discussed above, and is expected to continue along this path throughout the rulemaking period. OEMs are now forming relationships with battery manufacturers in an effort to research and develop not only new and improved battery technology, but also more efficient manufacturing processes capable of supporting high volume production. Accordingly, as shown in Table V-25, the \$600 per kW-hr used in the 2011 rule was revised downward to \$320 per kW-hr, matching that of the NiMH technology. The revision downward from \$600/kW-hr in the 2011 CAFE final rule to \$320/kW-hr in this analysis was done based a study by Deutsche Bank that estimated Li-Ion battery costs at 300-400 €/kW-hr.^v This was

converted to \$500/kW-hr then learned twice using volume-based learning to arrive at the \$320/kW-hr.

Li-ion batteries were originally restricted to plug-in hybrids only. Recent vehicle introductions confirm either battery technology can be used in any mild or strong HEV application. However, manufacturers are likely to consider cost highly in their selection of battery technology. If Li-ion battery prices decrease to levels similar to NiMH, Li-ion batteries would be the default battery technology for all hybrid electric vehicles. If Li-ion battery prices remain high, NiMH would be the default battery technology for all hybrid electric vehicles. For plug-in hybrids Li-ion would continue to be required because plug-in hybrids demand higher energy density than NiMH can provide. Neither the CAFE nor OMEGA model predicts a high penetration of plug-in technology in achieving the proposed standards.

Finally, the agencies assessed the cost savings associated with the FEAD credit discussed above. This cost was not previously represented in the hybrid cost model. As shown in Table V-25 below, a \$100 credit is proposed which offsets directly the costs of the other components specified. This is the best approximation of the value of these items, based on NHTSA and EPA engineering assessment.

Estimates of each key component are shown in Table V-25 below along with the sources of those estimates. The cost basis estimates assume fully learned, high-volume (greater than 1.2 million units per annum) production, and the costs shown are direct manufacturing costs that are not RPE or ICM adjusted. This table does not show a cost applicable to the belt integrated starter generator system (BISG) since it is a fixed cost that, like the automatic transmission pump cost, is not scaled by subclass as described later.

Table V-25 Component Cost Basis at High Volumes and Data Sources

COMPONENT	COST BASIS	DATA SOURCE
Primary Motor (\$/kW)	\$15	Martec 2008
Secondary Motor (\$/kW)	\$15	
Primary Inverter (\$/kW)	\$7	Confidential Business Information
Secondary Inverter (\$/kW)	\$7	
Controls	\$115	
NiMH Battery Pack (\$/kW-hr.)	\$320	2011 CAFE FRM (with revision)
Li-ion Battery Pack (\$/kW-hr.)	\$320	Deutsche Bank 2008
DC/DC Converter (Size: 2kW)	\$88	Confidential Business Information
High Voltage Wiring	\$200	Martec 2008
Supplemental Heating	\$42	
Mechanical Transmission	\$850	Martec 2008 (to 4-spd auto)
Electric Air Conditioning	\$450	Confidential Business Information
Blended Brakes	\$310	
Charger	\$100	
Automatic Transmission Pump	\$75	Martec 2008
FEAD Credit	\$(100)	Confidential Business Information

Third, NHTSA and EPA also revised component size/scaling assumptions for some vehicles (i.e., large trucks). NHTSA and EPA recognized that some manufacturers may choose not to use supplemental cabin heating opting instead to continue engine operation in the event heat demand occurs; therefore supplemental heating is specified for only half of the vehicles. Table V-25 above indicates the 50 percent application rate implemented in the hybrid cost estimating methodology reducing the component cost from \$84 to \$42.

EPA and NHTSA also reviewed the choice of a 3 kW DC/DC converter as a component size input for a midsize vehicle, which represented a 250 amp current capability. In retrospect this is a high specification for a midsize vehicle and we revised the estimate to a 2 kW DC/DC converter, as shown in Table V-25 above, which would represent a more reasonable 150 amp current capacity.

The scaling factor used for the primary and secondary motors and invertors on the large truck and SUV vehicles was revised. As in the MY 2011 CAFE final rule, a linear extrapolation was used from the midsize vehicle and extended it out to the largest of vehicles, the large truck class. This resulted in projected component sizes that are larger than those used on a commercially realized truck in this vehicle class, the Chevrolet Tahoe two-mode HEV. Accordingly the scaling factors have been revised for this class (and the agencies have verified scaling factors for the other classes). This more closely approximates the motor and inverter sizes specified in the Tahoe application. For future analysis, the agencies are considering whether it may be more accurate to use one set of scaling for passenger cars and another different set for light trucks.

Another revision involves the addition of a stand-alone higher voltage Start-Stop/BISG mild hybrid system. NHTSA and EPA determined that by applying a cost increase to the MHEV technology to allow for a voltage increase (lead acid batteries) and efficiency improvements to the alternator, the system would then approximate the higher voltage Start-Stop /BISG applied by EPA. Based on confidential sources, the estimates provided were first converted to 2007 dollars and then reverse learned through two cycles, since volume learning is applicable, to arrive at a non-RPE/ICM incremental compliance cost to be \$229. This cost is applicable to all classes that use higher voltage Start-Stop/BISG and is not scaled by any vehicle attribute.

Component scaling factors for each type of hybrid system as shown in Table V-26 below

Table V-26 Component Scaling Factors applied to Vehicle Class for each Hybrid System

Component	Hybrid Type				
	MHEV	CISG	PSHEV	2MHEV	PHEV
Primary Motor	Engine displacement	Curb weight	Curb weight ¹		Engine power
Secondary Motor	na	na	Engine displacement		Curb weight ²
Primary Inverter	Primary motor power				
Secondary Inverter	na	na	Secondary motor power		
Controls	Complexity				
NiMH Battery Pack	na	Curb weight			na
Li-Ion Battery Pack	na	Curb weight			Curb weight
DC/DC Converter	Curb weight ³				
High Voltage Wiring	na	Vehicle footprint			
Supplemental heating	Vehicle footprint				
Mechanical Transmission	Same for all vehicle classes				
Electric AC	na	na	Vehicle footprint		
Blended Brakes	na	Same for all vehicle classes			
Charger	na	na	na	na	Same for all vehicle classes

⁽¹⁾ For all vehicle classes except for performance classes which use Engine Torque

⁽²⁾ Curb weight used as surrogate for vehicle road load

⁽³⁾ Curb weight used as surrogate for vehicle electrical load

Regarding the market data file from the MY 2011 CAFE final rule, NHTSA and EPA did not make any revisions to the average vehicle characteristics for each vehicle subclass as shown in Table V-27, which defines the average vehicle characteristics for each vehicle subclass. These characteristics were used as the basis of the scaling factors in the Volpe model.

Table V-27 Key Vehicle Characteristics For Each Vehicle Subclass for CAFE model

Vehicle Subclass	Curb Weight (lbs)	Footprint (ft²)	Engine Disp. (L)	Engine Power (hp)	Torque (ft-lb)
Subcompact Car	2795	41	1.9	134	133
Compact Car	3359	44	2.2	166	167
Midsize Car	3725	47	2.9	205	206
Large Car	4110	50	3.4	258	248
Performance Subcompact Car	3054	40	2.7	260	260
Performance Compact Car	3516	44	3.0	269	260
Performance Midsize Car	3822	47	3.9	337	318
Performance Large Car	4189	51	4.8	394	388
Minivan	4090	50	3.3	247	242
Small Truck	3413	45	2.6	178	185
Medium Truck	4260	50	3.6	250	256
Large Truck	5366	63	5.0	323	352

(19) Electrical Power Steering (EPS)

Electric power steering (EPS) provides a potential reduction in fuel consumption over hydraulic power steering because of reduced overall accessory loads. This eliminates the parasitic losses associated with belt-driven power steering pumps which consistently draw load from the engine to pump hydraulic fluid through the steering actuation systems even when the wheels are not being turned. Additionally EPS is an enabler for all vehicle hybridization technologies, since it provides power steering when the engine is off, and thus NHTSA places the technology at the top of the electrification decision tree. While EPS may be implemented on most vehicles with a standard 12V system, heavier vehicles may require a higher voltage system which may add cost and complexity.

In the 2011 final rule NHTSA estimated a 1 to 2 percent effectiveness based on the 2002 NAS report, a Sierra Research report, and confidential manufacturer data. NHTSA reviewed these effectiveness estimates and found them to be accurate, thus they have been retained for this proposal.

For costs, in the MY 2011 CAFE final rule, NHTSA estimated EPS at \$105 - \$120 at a 1.5 RPE markup factor. NHTSA, working in conjunction with EPA, adjusted the EPS cost for the current proposal based on a review of the specification of the system. Adjustments were made to the potentially higher voltage or heavier duty system operation, such as would be required on some hybrid trucks. Accordingly, higher costs were estimated for EPS due to the system's higher capability. After accounting for the differences in system capability and applying the ICM markup of low complexity

technology of 1.11, the estimated costs for this rulemaking are \$106 for a MY 2012 vehicle. As EPS systems are in wide spread usage today, time based learning is also deemed applicable, hence costs will be lower for later MY vehicles. The Volpe model can apply EPS at refresh or redesign cycles, since it is a reasonably non-intrusive technology. Whereas the 2011 final rule did not apply EPS to the Large Truck and SUV subclass, primarily due to concerns with the system's capability, there are no subclass specific limitations on its use in this proposal for the reasons stated above. The phase-in cap has been set at 85 percent in MYs 2012 to 2014, and 100 percent thereafter,

(20) Improved Accessories (IACC)

The accessories on an engine, including the alternator, coolant and oil pumps are traditionally mechanically driven. A reduction in fuel consumption can be realized by driving them electrically, and only when needed (i.e., "on-demand").

As the oil pump provides lubrication to the engine's sliding surfaces such as bearings, pistons, and camshafts, oil flow must be provided whenever the engine is rotating. Because mechanical oil pumps do not operate when the engine is not rotating, there is no efficiency benefit for the ability of an electric oil pump to be switched off when the engine is not rotating. The increased complexity of an electric oil pump system creates greater reliability risk compared to a conventional mechanical oil pump, and increases risk for significant engine damage should the system fail, even momentarily.

Electric water pumps and electric fans can provide better control of engine cooling. For example, coolant flow from an electric water pump can be reduced and the radiator fan can be shut off during engine warm-up or cold ambient temperature conditions which will reduce warm-up time, reduce warm-up fuel enrichment and reduce parasitic losses. Further benefit may be obtained when electrification is combined with an improved, higher efficiency engine alternator. Vehicles that typically carry heavy payloads, or that are used for towing have high cooling system and cooling fan loads, and benefit less for intelligent cooling. Therefore, intelligent cooling is not applied to the Large LT subclass. In the CAFE model, IACC refers solely to improved engine cooling.

NHTSA reviewed the 1 to 2 percent IACC effectiveness estimates used in MY 2011 rule and found them to be accurate for this proposal. NHTSA also confirmed the cost assumptions from the final rule and thus only adjusted the costs to reflect the new ICM markup for a low complexity technology of 1.11; this results in a cost estimate for this rulemaking of \$128 at MY 2012. Since these systems are readily available and in production currently time based learning is applied. The Volpe model can apply IACC at either refresh or redesign cycle however application to the Large Truck and SUV subclass is prohibited due to the cooling system requirements of these high utility vehicles. The phase-in rate has been defined as 85 percent in MYs 2012 to 2014, and 100 percent thereafter.

(21) 12V Micro Hybrid (MHEV)

The 12V Micro-Hybrid (MHEV) systems are the most basic of hybrid systems and offer only the ability to turn the engine off when the vehicle is stopped or potentially during deceleration (i.e. idle stop). Their low cost and adaptability to existing

powertrains and platforms can make them attractive for some applications. The conventional belt-driven alternator is replaced with a belt-driven, enhanced power starter-alternator and a redesigned front-end accessory drive system. A conventional 12V gear-reduction starter is retained to ensure reliable cold-weather starting. Also, during idle-stop, some functions such as power steering and automatic transmission hydraulic pressure are lost; so electric power steering and an auxiliary transmission pump may be needed. A schematic of the MHEV system is shown in Figure V-13.

In the 2011 final rule, the effectiveness estimates for this technology ranged from 2.0 to 4.0 percent dependent on whether the vehicle is equipped with a 4, 6 or 8 cylinder engine, with the 4 cylinder engine having the lowest range and the 8 cylinder having the highest. The estimates reflect the limited capability of 12 volt systems which do not recover mechanical energy through regenerative braking or provide motive force; sources citing higher estimates typically involve higher voltage systems that have increased capability.

For this proposal, the system specifications assumed in the 2011 rule¹⁵¹ were applied (i.e., use of a 3 kW motor and a DC/DC converter) and the hybrid technology cost method was used to produce system costs, like was done in 2011 rule. However, the use of revised component costs and new ICM markups resulted in costs ranging from a low of \$288 for Subcompact subclass to a high of \$410 for the Large Performance subclass, both of which are for MY 2012 vehicles. This technology is not applied to the Large Truck and SUV subclass due to the higher utility requirements of these vehicles; however this is the only subclass limitation of the MHEV technology. Time based learning is considered applicable, and thus system costs are lower in later MYs. Application by the Volpe model is limited to the redesign cycle since the front engine accessory drive will likely require significant redesign with a phase-in cap of 85 percent for all MYs.

Figure V-13 Schematic of MHEV Type System [Husted, 2003]

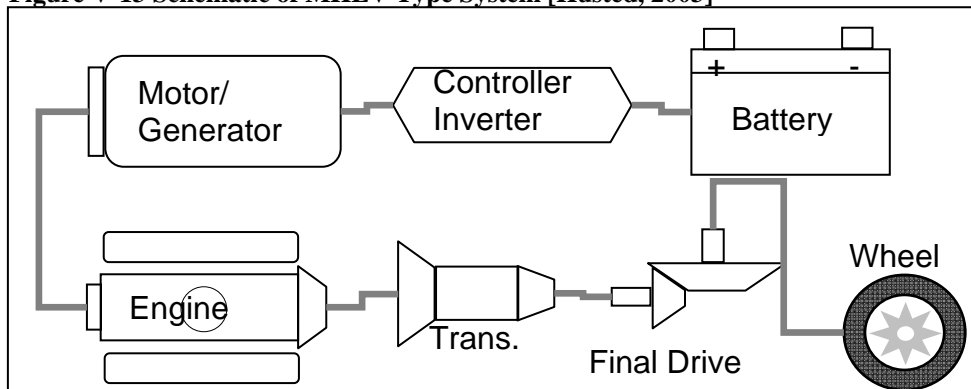

Higher Voltage Stop-Start/Belt Integrated Starter Generator (BISG)

¹⁵¹ 74 FR 14293 (Mar. 30, 2009)

Belt Mounted Integrated Starter Generator (BISG) systems are higher voltage stop-start similar to a micro-hybrid system, offering idle-stop functionality except that they utilize larger electric machine and a higher capacity battery, typically 42 volts or above, thus enabling a limited level of regenerative braking which is generally not available to 12 volt based systems. The larger electric machine and battery also enables a limited degree of power assist, which MHEV cannot provide. However, because of the limited torque capacity of the belt driven design, these systems have a smaller electric machine, and thus less capability than crank integrated or stronger hybrid systems. These systems replace the conventional alternator with a belt-driven starter/alternator. The limited electrical requirements of these systems allow the use of lead-acid batteries or supercapacitors for energy storage. Schematically BISG is similar to the MHEV technology.

NHTSA did not have an equivalent technology to BISG in the 2011 final rule (the ISG technology used in the 2011 rule was envisioned to be more capable than BISG). Effectiveness estimates for higher voltage stop-start systems found in literature and reports typically range from 3.0 to 7.5 percent, relative to a vehicle without stop-start, and dependent on a number of vehicle characteristics such as engine displacement and vehicle size. The Volpe model, which applies BISG incrementally to the MHEV technology, uses incremental estimates of 3 to 6 percent in this proposal, which makes the net effectiveness comparable to the estimates found in the 2002 NAS and 2004 NESCAFF reports for higher voltage stop-start systems. This estimate applies for all vehicle subclasses except Large Truck and SUV where, due to their high utility requirements, the BISG technology is not considered applicable.

For this proposal, the cost estimate used by the Volpe model, which is incremental to the MHEV technology, adjusts the costs upwards by \$286 to reflect the need for additional battery capacity, wiring upgrades, and a larger optimized electric machine. The cost estimates reflects volume based learning factors, since these systems are in relatively low usage at this time, and an ICM complexity markup of 1.25 for a medium complexity technology. Like MHEV, BISG can only be applied at redesign cycles times, and a flat 85 percent phase-in setting exists for all MYs.

(22) Crank Integrated Starter Generator (CISG)

Integrated motor assist (IMA) is a commercially realized system developed and marketed by Honda. This is similar to the CISG technology represented in the Volpe model. They utilize a thin axial electric motor bolted to the engine's crankshaft and connected to the transmission through a torque converter or clutch. The axial motor is motor/generator that typically operates above 100 volts (but lower than the stronger hybrid systems discussed below, which typically operate at about 300 volts) and can provide torque for launch as well as generate current to provide significant levels of brake energy recovery. The motor/generator also acts as the starter for the engine and can replace a typical accessory-driven alternator. Current CISG systems typically do not fully launch the vehicle on electric power alone, although some can cruise on electric power; dual-clutch based CISG systems capable of all-electric drive are under development. A schematic of the Honda's IMA system is shown in Figure V-13.

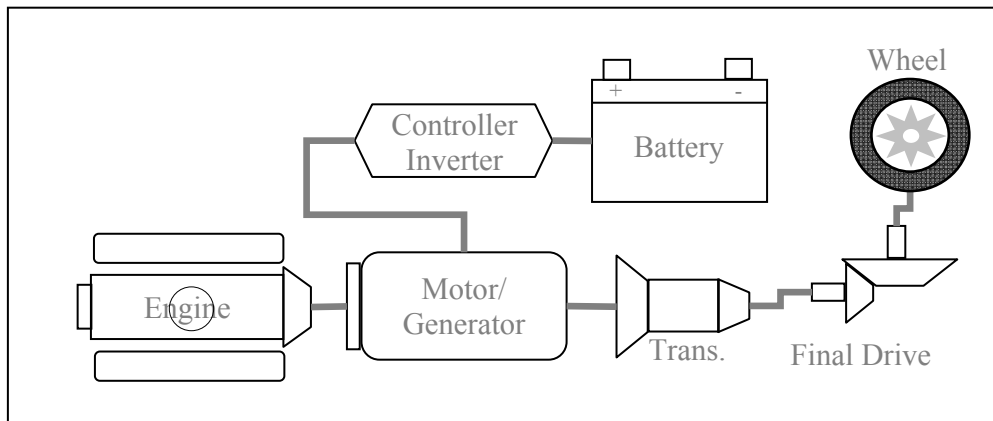
Figure V-14 Schematic of Honda IMA System [Husted, 2003]

NHTSA did not have an equivalent technology to CISG in the 2011 final rule (the ISG technology used in the 2011 rule was envisioned to be less capable than the CISG technology defined here). For the CISG technology NHTSA estimated a net effectiveness range of 16 to 20 percent, relative to the baseline vehicle and across all vehicle subclasses in this analysis. The Volpe model therefore applies an incremental effectiveness of approximately 8.6 to 8.9 percent relative to the BISG technology and dependent on vehicle subclass except for large truck and SUV in which case BISG does not apply. Note that the net effectiveness assumptions used in this proposal do not include engine downsizing, or any other effectiveness gains from engine, transmission, or vehicle technologies added to the vehicle by the modeling process.

Using the hybrid cost estimating method, as discussed above, NHTSA has determined a compliance cost range of \$2,791 for a Subcompact vehicle to \$5,124 for the Large Truck and SUV vehicles, both in MY 2012. These include a high complexity ICM markup factor of 1.45 for this technology. As CISG is still in limited production use, volume based learning is applied which results in lower costs as the model applies sufficient quantities and applies two cycles of 20 percent cost reduction. CISG is applicable to all vehicle subclasses. Since significant vehicle modification is required to implement this technology the Volpe model only applies CISG during a redesign cycle. NHTSA assumed a 3 percent phase-in cap for CISG in MY2012 and increasing 3 percent per year reaching a maximum of 15 percent in MY 2016.

(23) **Power Split Hybrid (PSHEV)**

The Power Split hybrid has the ability to move the vehicle on electric power only. It replaces the vehicle's transmission with a single planetary gear and a motor/generator. A second, more powerful motor/generator is directly connected to the vehicle's final drive. The planetary gear splits engine power between the first motor/generator and the final drive. The first motor/generator uses power from the engine to either charge the battery or supply power to the wheels. The speed of the first motor/generator determines the relative speed of the engine to the wheels. In this way, the planetary gear allows the engine to operate independently of vehicle speed, much like a CVT. The Toyota Prius and the Ford Hybrid Escape are two examples of power split hybrid vehicles.

In addition to providing the functions of idle engine stop, subsequent restart and regenerative braking, this hybrid system allows for pure EV operation. The power split system provides good fuel consumption in city driving. During highway cycles, the hybrid functions of regenerative braking, engine start/stop and optimal engine operation cannot be applied as often as in city driving, and so the effectiveness in fuel consumption is slightly less. Additionally, it is less efficient at highway speeds due to the fact that the first motor/generator must be spinning at a relatively high speed and therefore incurs losses. Newer designs incorporate a gear-reduction motor to provide improved high speed efficiency and improved matching of motor torque to engine torque.

The Power Split hybrid also reduces the cost of the transmission, replacing a conventional multi-speed unit with a single planetary gear. The electric components are bigger than those in mild hybrid and CISH configurations so the costs are correspondingly higher.

During development of the joint rulemaking, NHTSA in conjunction with EPA, reviewed manufacturer-supplied information that compared cars and small trucks available with and without a PSHEV hybrid system. The data was taken from EPA's fuel economy test data and indicated a combined cycle tailpipe CO₂ reductions, which are equivalent to fuel consumption reductions, for the PSHEV equipped vehicles compared to the conventional vehicles that ranged from 19 to 36 percent, see Table V-28 and V-29¹⁵². Considering the Volpe model's incremental approach to technology application, where engine downsizing and other vehicle related effectiveness improvements are accounted for on other technology decision trees, NHTSA determined that net effectiveness estimates of 23 to 33 percent were most appropriate for the PSHEV technology in this analysis. These net effectiveness values result in incremental effectiveness estimates that range from approximately 6 to 12 percent depending on vehicle subclass and relative to a CVT.

Table V-28 Large Car Power Split Certification Data

	City	Tailpipe CO ₂ Hwy	55/45 comb.
Nissan Altima			
3.5L CVT	444	306	386
HEV 2.5L PS	317	254	286
Net % difference			-26%
Toyota Camry			
3.0L 5-auto	404	286	355
HEV 2.4L PS	222	234	228
Net % difference			-36%
Lexus GS			
4.3L 6-auto	493	355	423

¹⁵² The manufacturer data shows that, for the most part, the PSHEV equipped vehicles in the comparisons utilized engine downsizing, however the data is not intended to identify all other differences that may exist between the hybrid and non-hybrid vehicle versions, such as hybrid-specific powertrain calibrations or other vehicle modifications (tires, mass reductions, etc). Readers should exercise caution in assuming that all of the noted fuel consumption gains can be attributed solely to engine downsizing and the use of the PSHEV technology as there may be other modifications or systems that also contributed.

HEV 3.5L PS	355	317	341
Net % difference			-19%

Table V-29 Small Truck Power Split Certification Data

	City	Tailpipe CO ₂ Hwy	55/45 comb.
Ford Escape 4X4			
3.0L 4-auto	467	386	423
HEV 2.3L PS	277	306	286
Net % difference			-32%
Ford Escape 4X2			
3.0L 4-auto	444	370	404
HEV 2.3L PS	247	286	261
Net % difference			-35%
Toyota Highlander 4X4			
3.3L 5-auto	493	370	423
HEV 3.3L PS	286	329	306
Net % difference			-28%

Using the hybrid cost estimating method NHTSA established overall PSHEV system costs, which include the use of Electric Power Steering (EPS) and Improve Accessories (IACC) technologies, ranging from \$5,509 for the Subcompact subclass to \$11,534 for the Performance Large Car subclass for MY 2012 vehicles. In the Volpe model these net costs result in incremental costs ranging from \$1,600 to \$6,723 depending on vehicle subclass. The costs were determined using a 1.45 ICM for the high complexity PSHEV technology. Volume based learning is applicable to power split technology, so costs reduce significantly as penetration levels increase sufficiently. In the Volpe model PSHEV is not applicable to the Large Truck and SUV subclass primarily due to the high utility requirements of these vehicles. PSHEV implementation requires significant vehicle revision, therefore its application is restricted to redesign cycles only. For the strong hybrid technologies, NHTSA used phase-in caps of 3 percent per MY, so the maximum application rate occurs in MY 2016 at 15 percent.

(24) **2-Mode Hybrid**

The 2-Mode Hybrid (2MHEV) uses an adaptation of a conventional stepped-ratio automatic transmission which replaces some of the transmission clutches with two electric motor/generators allowing the transmission to act like a CVT. The motor/generators control the ratio of engine speed to vehicle speed. The clutches allow the motors to be bypassed improving the transmission's torque capacity and the efficiency for improved fuel economy at highway speeds and to meet the requirements needed for towing and high payload capacity. This type of system is used in the Chevrolet Tahoe Hybrid.

In addition to providing the hybrid functions of engine stop and subsequent restart and regenerative braking, the 2MHEV allows for pure EV operation. The two motor/generators allow the engine to be run in efficient operating zones. The primary motor/generator is comparable in size to that in the PSHEV system, but the secondary

motor/generator is larger. The 2-mode system cost is greater than that for the power split system due to the additional transmission complexity and secondary motor sizing.

For this proposal, and for similar reasons as discussed above in the PSHEV section, the CAFE model considered a net effectiveness range of 23 to 33 percent, assuming no engine downsizing so as to preserve the utility nature of medium and large trucks where the 2MHEV technology is applied (e.g., maintaining full towing capability even in situations with low battery charge). These estimates lead to incremental effectiveness values ranging from approximately 3 to 9.5 percent for the truck subclasses, and relative to a CVT.

NHTSA estimated MY 2012 costs using the updated component costs and scaling factors in the hybrid cost estimating methodology discussed above and determined incremental cost estimates ranging from \$3,521 to \$5,779 for the three light duty truck applications. These estimates include the 1.45 ICM markup value for high complexity 2MHEV technology; volume based learning is applicable. The 2MHEV technology is only applied by the Volpe model at redesign cycle times, and it is not applicable to any of the passenger car subclasses. NHTSA used a 3 percent per MY phase-in cap, so the maximum application rate occurs in MY 2016 at 15 percent.

(25) Plug-In Hybrid

Plug-In Hybrid Electric Vehicles (PHEVs) are very similar to Hybrid Electric Vehicles, but with three significant functional differences. The first is the addition of a means to charge the battery pack from an outside source of electricity (e.g. the electric grid). Second, a PHEV would have a larger battery pack with more energy storage, and a greater capability to be discharged. Finally, a PHEV would have a control system that allows the battery pack to be significantly depleted during normal operation.

Table V-30 below, illustrates how PHEVs compare functionally to both hybrid electric vehicles (HEV) and electric vehicles (EV). These characteristics can change significantly within each class/subclass, so this is simply meant as an illustration of the general characteristics. In reality, the design options are so varied that all these vehicles exist on a continuum with HEVs on one end and EVs on the other.

Table V-30 Conventional, HEVs, PHEVs, and EVs Compared

Attribute	Increasing Electrification			
	Conventional	HEV	PHEV	EV
Drive Power	Engine	Blended Engine/Electric	Blended Engine/Electric	Electric
Engine Size	Full Size	Full Size or Smaller	Smaller or Much Smaller	No Engine
Electric Range	None	None to Very Short	Short to Medium	Medium to Long
Battery Charging	None	On-Board	Grid/On-Board	Grid Only

Deriving some of their propulsion energy from the electric grid provides several advantages for PHEVs. PHEVs offer a significant opportunity to replace petroleum used for transportation energy with domestically-produced electricity. The reduction in petroleum usage does, of course, depend on the amount of electric drive the vehicle is capable of under its duty cycle. PHEVs also provide electric utilities the possibility to increase electric generation during “off-peak” periods overnight when there is excess generation capacity and electricity prices are lower. Utilities like to increase this “base load” because it increases overall system efficiency and lowers average costs. Utilities are also investigating the use of PHEV and EV batteries as a source of grid storage capacity to provide ancillary services for grid stabilization purposes. Unlike most other alternative fuel technologies, PHEVs can initially use an existing infrastructure for refueling (charging and liquid refueling) so investments in infrastructure may be reduced.

PHEVs will be considerably more costly than conventional vehicles and some other advanced technologies. To take advantage of their capability, consumers would have to be willing to charge the vehicles nightly, and would need access to electric power where they park their vehicles. For many urban dwellers who may park on the street, or in private or public lots or garages, charging may not be practical. Charging may be possible at an owner’s place of work, but that would increase grid loading during peak hours which would eliminate some of the benefits to utilities of off-peak charging vs. on-peak. Oil savings will still be the same in this case assuming the vehicle can be charged fully.

The effectiveness potential of PHEVs depends on many factors, the most important being the energy storage capacity designed into the battery pack. To estimate the fuel consumption and tailpipe CO₂ reduction potential of PHEVs, EPA has developed an in-house vehicle energy model (PEREGRIN) to estimate the fuel consumption/CO₂ emissions reductions of PHEVs. This model is based on the PERE (Physical Emission Rate Estimator) physics-based model used as a fuel consumption input for EPA’s MOVES mobile source emissions model.

PHEVs can have a wide variation in the All Electric Range (AER) that they offer. Some PHEVs are of the “blended” type where the engine is on during most of the vehicle operation, but the proportion of electric energy that is used to propel the vehicle is significantly higher than that used in a PSHEV or 2MHEV. In this analysis, each PHEV was modeled with enough battery capacity for a 20-mile-equivalent AER and a power requirement to provide similar performance to a hybrid vehicle. 20 miles was selected because it offers a good compromise for vehicle performance, weight, battery packaging and cost. Given expected near-term battery capability, a 20 mile range represents the likely capability that will be seen in PHEVs in the near-to-mid term.

To calculate the total energy use, the PHEV can be thought of as operating in two distinct modes, electric (EV) mode, and hybrid (HEV) mode. During EV operation the fuel consumption is zero. The EV mode fuel economy can then be combined with the HEV mode fuel economy using the Utility Factor calculation in SAE J1711 to determine a total MPG value for the vehicle. (See TableV-31)

TableV-31 Sample Calculation of PHEV Gasoline-Equivalent CO₂ Reduction

	Midsize Car
EV energy comb (0.55 city / 0.45 hwy)	0.252 kwh/mi
EV range (from PEREGRIN)	20 miles
SAE J1711 utility factor	0.30
HEV mode comb FE (0.55 city / 0.45 hwy)	49.1 mpg
Total UF-adjusted FE (UF*FCEV + (1-UF)*FCHEV)	70.1 mpg
Baseline FE	29.3 mpg
Percent FE gain	139%
Percent CO ₂ reduction	-58%

Calculating a total reduction based on model outputs and the Utility Factor calculations results in a 58 percent reduction in fuel consumption for midsize and smaller passenger cars and small trucks and SUVs. This value is used as the net effectiveness estimate for these subclasses in the Volpe model, yielding incremental estimates of approximately 46 percent relative to CVT and independent of engine and other vehicle related effectiveness improvements. The CAFE model does not apply the PHEV technology to Large Cars and the Medium and Large Truck and SUV subclasses.

Using the hybrid cost estimating model and updated component costs, NHTSA determined MY 2012 incremental cost estimates for the Volpe model ranging from a low of approximately \$11,500 for a subcompact car to a high of approximately \$19,000 for a midsize performance car. This includes the 1.64 ICM markup value for very high complexity technology. Volume based learning lowers the costs in later model years, and a phase-in cap of 3 percent per MY is also applied.

d. Vehicle Technologies

(26) Mass Reduction

Reducing a vehicle's mass, or down-weighting a vehicle, decreases fuel consumption by reducing the energy demand needed to overcome forces resisting motion, and rolling resistance. Manufacturers employ a systematic approach to mass reduction where the net mass reduction is the addition of a direct component or system mass reduction plus the additional mass reduction taken from indirect ancillary systems and components, as a result of full vehicle optimization, effectively compounding or obtaining a secondary mass reduction from a primary mass reduction. For example, use of a smaller, lighter engine with lower torque output subsequently allows the use of a smaller, lighter-weight transmission and drive line components. Likewise the compounded mass reductions of the body, engine and drivetrain reduce stresses on the suspension components, steering components, wheels, tires and brakes, allowing further reductions in the mass of these subsystems. The reductions in unsprung masses such as brakes, control arms, wheels and tires further reduce stresses in the suspension mounting points. This produces a compound effect of mass reductions, which results in the so-called ripple effect.

Estimates of the synergistic effects of mass reduction and the compounding effect that occurs along with it can vary significantly from one report to another. For example, in discussing its estimate, an Auto-Steel Partnership report states "These secondary mass

changes can be considerable—estimated at an additional 0.7 to 1.8 times the initial mass change.”¹⁵³ This means for each one pound reduction in a primary component, up to 1.8 pounds can be reduced from other structures in the vehicle (i.e., a 180% factor). The report also discusses that a primary variable in the realized secondary weight reduction is whether or not the powertrain components can be included in the mass reduction effort, with the lower end estimates being applicable when powertrain elements are unavailable for down-weighting. However another report by the Aluminum Association, which primarily focuses on the use of aluminum as an alternative material for steel, estimated a factor of 64 percent for secondary mass reduction even though some powertrain elements were considered in the analysis.¹⁵⁴ That report also notes that typical values for this factor vary from 50 to 100 percent. Although there is a wide variation in stated estimates, synergistic mass reductions exist and the effects result in tangible mass reductions. Mass reductions in a single vehicle component, for example a door side impact / intrusion system, may actually result in a significantly higher weight savings in the total vehicle, depending on how well the manufacturer integrates the modification into the overall vehicle design. Accordingly care must be taken when reviewing reports on weight reduction methods and practices to ascertain if compounding effects have been considered or not

Manufacturers consider and utilize various methods and options for achieving vehicle mass reductions. One of the more common methods, and one which NHTSA has considered in prior rulemakings, is material substitution, where lower density and/or higher strength materials are utilized in a manner that preserves or improves the function of a component under consideration for redesign¹⁵⁵. Computer aided engineering (CAE) tools are another important method of improving structural strength and component designs so as to better optimize load paths and reduce stresses and bending moments applied to them. This allows better optimization of the dimensional aspects of the component (and thus its mass) while maintaining or potentially improving the function, or may integrate unique parts in a manner that reduces mass by combining functions or eliminating separate fasteners. An example of CAE in the extreme would be a traditional “body on frame” vehicle which is redesigned with a lighter “unibody” construction, where the new design optimizes exterior body size, passenger compartment space, powertrain layout and capacity, and the footprint dimension, while giving careful consideration of the utility and market position within the particular segment the vehicle competes in. Vehicle crashworthiness and safety performance must also be considered and at least preserved, if not improved.

¹⁵³ “Preliminary Vehicle Mass Estimation Using Empirical Subsystem Influence Coefficients,” Malen, D.E., Reddy, K. Auto-Steel Partnership Report, May 2007. Accessed on the Internet on May 30, 2009 at: <http://www.a-sp.org/database/custom/Mass%20Compounding%20-%20Final%20Report.pdf>

¹⁵⁴ “Benefit Analysis: Use of Aluminum Structures in Conjunction with Alternative Powertrain Technologies in Automobiles,” Bull, M. Chavali, R., Mascarin, A., Aluminum Association Research Report, May 2008. Accessed on the Internet on April 30, 2009 at: <http://www.autoaluminum.org/downloads/IBIS-Powertrain-Study.pdf>

¹⁵⁵ This includes substitution of high-strength steels, aluminum, magnesium or composite materials for components currently fabricated from mild steel.

Regardless of how a vehicle's mass is actually reduced, and what level if any of secondary mass reduction is achieved, the fuel consumption reductions that result are fairly straightforward. A number of researchers and reports have examined the fuel consumption vs. weight reduction question for a variety of vehicle and engine types. For the most part, one primary variable exists which thereby bounds the two possible alternatives¹⁵⁶, that being whether or not the mass reductions result in: a) improved vehicle performance, such as 0 to 60 times, towing capacity; or power to weight ratio, or alternatively b) performance metrics that remain constant as a result of the weight reduction. This second alternative, with constant performance metrics, is accomplished through the application of engine resizing (e.g. engines with smaller displacements which consume less fuel) that offsets the performance enhancing effects of the weight reduction, which from a fuel consumption perspective is obviously the more preferable approach. Thus two fuel consumption effectiveness estimates relating to mass reduction are generally stated in reports and literature, one which assumes improved vehicle performance (i.e., the engine displacement is unchanged), and one which assumes constant performance (i.e., the engine is resized). For the improved performance case, a 10 percent reduction in vehicle curb weight is generally expected to reduce fuel consumption by 3 to 4 percent. When appropriate engine resizing is applied and vehicle performance is held constant, a 10 percent curb weight reduction results in a 6 to 7 percent fuel consumption savings. Both of these estimates are documented in literature and reports on the subject of mass reduction, including the 2002 NAS report, and are also supported by simulation work conducted by Ricardo, Inc.¹⁵⁷, an internationally recognized consultant who, under contract, has assisted both EPA and NHTSA in technical and rulemaking related matters.

In preparation for this proposal, in March 2009, NHTSA made a request for confidential product plan and other CAFE related technical information from manufacturers that produce light vehicles for sale in the U.S.¹⁵⁸ Not every manufacturer responded, and those that did in some cases either resubmitted materials previously provided to the agency or submitted truncated responses, which is understandable given the turmoil and uncertainty the industry was experiencing at that time. Regardless NHTSA reviewed the responses related to the subject of mass reduction and the vehicle weight trends likely to occur in the MY 2012 – 2016 fleet. These responses didn't show a consistent approach. In some cases manufacturers are indicating weight increases (due either to more stringent FMVSS requirements or new model plans that incorporate

¹⁵⁶ A third alternative would be to degrade the vehicle such that mass reduction and engine downsizing results in lower performance metrics however a primary objective established by NHTSA is that the modeling process does not perceptibly change the use, function, or utility of the vehicle under consideration, therefore this is not a viable alternative.

¹⁵⁷ "Benefit Analysis: Use of Aluminum Structures in Conjunction with Alternative Powertrain Technologies in Automobiles," Bull, M. Chavali, R., Mascarin, A., Aluminum Association Research Report, May 2008. Accessed on the Internet on April 30, 2009 at: <http://www.autoaluminum.org/downloads/IBIS-Powertrain-Study.pdf>

¹⁵⁸ This was in addition to similar requests made during the MY 2011 final rule and the 2008 NPRM that preceded it. The request also preceded the President's May 19, 2009 announcement regarding fuel economy and green house gas standards. NHTSA notes that some manufacturers also made submissions to Congress and other governmental agencies where plans regarding future fleet planning, in terms of sales volumes and fleet configuration, were also discussed.

heavier platforms or more content), in other cases no significant change is noted either way, and in some cases the submissions are outdated or incomplete (e.g., impacts of the Fiat and Chrysler relationship and its effects on future product offerings). Although several OEMs have recently made public announcements indicating their intentions to decrease light vehicle average fleet weights within the upcoming years, the confidential product plans, to the extent they are a suitable source for making such a determination, do not appear to support this contention.

However one manufacturer did submit what appears to the agency to be a comprehensive response to the March request which does show significant curb weight decreases on the order of 350 to 550 pounds occurring within the timeframe. Although the stated reductions are sizeable, representing some 5 to 10 percent of the vehicle's curb weight, some notes about the information provided are appropriate. First off, in all cases these larger reductions are being implemented at product redesign cycles only, and the earliest of these occurs in the MY 2014 period.¹⁵⁹ Secondly, the affected vehicles are from various vehicle segments, including cars and trucks, which represent high sales volume and a sizeable portion of the manufacturer's overall production. And lastly the information provided does not describe, in any detail, how the specific reductions will be achieved (what techniques will be used, etc.), or what effect the changes will have on the vehicle's physical dimensions, utility, or performance (safety and otherwise) afterwards. So while this information does support the belief that meaningful weight reductions are possible, and that at least one OEM is intending to implement them, it does not contain some of the information needed for a more robust analysis.

To gain further insight, NHTSA briefly discussed plans for weight decreases on future products with a few vehicle manufacturers. Although discussion of the methods used to achieve the reductions, and their impacts on dimensions and vehicle performance, were not within the scope of the conversations, the manufacturers did generally indicate their plans for decreasing fleet weights throughout the rulemaking period, with ranges of 5 to 10 percent net curb weight decreases considered potentially realizable by MY 2016. In past rulemakings, where confidential product plan information was, to the extent possible, used to establish the future fleet composition, this included the manufacturer's estimate for a future product's fuel economy rating. Therefore, in these analyses, technology changes such as weight reductions would have theoretically been accounted for in the Volpe modeling process. In the current proposal, where a baseline MY 2008 fleet is projected forward into a future fleet, planned technology changes such as reductions in vehicle weights, cannot be accounted for in this way, since there was no practical way of doing so. So to the extent mass reductions do occur in this rulemaking's future fleet, the Volpe modeling process will not account for their potential on fuel consumption without some further revision, as discussed below.

In the MY 2011 final rule NHTSA utilized three cumulative material substitution technologies that resulted in a maximum 5 percent reduction in vehicle curb weight. Material substitution was intended to be the primary means by which the weight

¹⁵⁹ The reductions might be best characterized as an objective for a new model platform that the company seeks to obtain.

reductions would be achieved. The three technologies were only applied to vehicles with curb weights in excess of 5,000 pounds which effectively limited their applicability to large trucks and SUVs. This was done on the basis that weight reduction from the heaviest of the vehicles in the U.S. fleet represented the most safety neutral, or potentially safety beneficial method of reducing vehicle weight. Since only large trucks were impacted, where towing and hauling capability is required, NHTSA used a 3.5 percent fuel consumption reduction per 10 percent weight decrease (i.e., no engine resizing was assumed). NHTSA has revised its approach for mass reduction in the current analysis, as is discussed in the following paragraphs.

In this proposal, and in contrast to the 2011 rule, the Volpe model now applies two mass reduction technologies using a tiered approach. Mass reduction is intended to encompass a broader spectrum of methods for reducing vehicle mass, such as those discussed above, and those beyond material substitution, and is intended to be applicable to all vehicle subclasses, regardless of curb weight. Additionally in this analysis NHTSA considers that vehicle performance metrics are maintained constant as a result of the mass reductions, so appropriate levels of engine resizing are assumed.

The first of these technologies is MS1 which represents a 1.5 percent vehicle curb weight mass reduction across all vehicle subclasses. This technology is available to the Volpe model from the start of the rulemaking period, MY 2012, and may be applied during both the refresh and the redesign cycle time. For the level of mass reduction required, material substitution techniques, or other relatively easy to implement methods, are envisioned for achieving the weight savings. It is anticipated that this could occur during the early MYs of the rulemaking period and at the proposed cycle times.

The second mass reduction technology is MS2, which occurs subsequent to, and is cumulative to, the MS1 technology. Since MS2 requires more rigorous mass reduction, additional constraints are utilized in its application. MS2 involves mass reductions of 3.5 to 8.5 percent of curb weight dependent on which vehicle subclass it is applied to. This first constraint, which varies the level of reduction by subclass, results in lower levels of mass reduction in the smaller (and lighter) vehicles, and larger levels conversely for the larger (and heavier) vehicles. This is intended to reflect, to the extent possible, the agency's past practice of reducing vehicle weights in the most safety neutral manner; smallest reductions in the smallest vehicles, largest reductions in the largest vehicles. Secondly, the MS2 technology is made unavailable to the Volpe model until MY 2014 and thus constrained on the basis that the larger levels of mass reductions required, and the types of methods and techniques needed to achieve them, cannot realistically occur without sufficient leadtime for planning. In all likelihood these levels of mass reduction can only be achieved through a major redesign of the vehicle, which was what lead NHTSA to set the cycle time for the MS2 technology to redesign only, which is the final constraint used in the modeling process. Table V-32 below summarizes the mass reductions, as a percent of curb weight, for the MS1, MS2, and the combined effects by each vehicle subclass they are applied to. When both MS1 and MS2 are applied, overall mass reduction of 5 to 10 percent can occur, dependent on vehicle subclass.

Table V-32
Vehicle Mass (Weight) Reduction as a Percent of Curb Weight Due to the Application of
the MS1, MS2, and the Combination of Both Technologies

Vehicle Class	MS1 (%) Refresh/Redesign	MS2 (%)* Redesign only	Maximum Total Reduction (%)
Subcompact PC	1.5	3.5	5.0
Compact PC	1.5	3.5	5.0
Midsize PC	1.5	6.0	7.5
Large PC	1.5	8.5	10.0
Subcompact Performance PC	1.5	3.5	5.0
Compact Performance PC	1.5	3.5	5.0
Midsize Performance PC	1.5	6.0	7.5
Large Performance PC	1.5	8.5	10.0
Small LT	1.5	6.0	7.5
Midsize LT	1.5	6.0	7.5
Large LT and Minivan	1.5	8.5	10.0

* - MS2 is unavailable until MY2014

For effectiveness, and as discussed above, NHTSA assumes in this proposal that a 10 percent reduction in mass results in a 6.5 percent reduction in fuel consumption (regardless of reduction technique used or the compounding factor achieved). This approach is intended to yield equivalent vehicle performance (i.e. 0-60 mph time, towing capacity, etc.) and assumes that appropriate engine resizing occurs. In developing costs for this proposal NHTSA and EPA reviewed three studies of down-weighting/material substitution and the associated cost. The first study, the NAS report, estimated that vehicle weight could be reduced for approximately \$1.50 per pound. (3-4% reductions in fuel consumption, without engine downsizing, from a 5% reduction in vehicle weight at a cost of \$210-\$350. This translates into \$1.50 per pound, assuming a 3800 pound base vehicle and using the midpoint cost.) Additionally, Sierra Research estimated a 10% reduction, with compounding, could be accomplished for a cost of \$1.01 per pound. Finally, MIT estimated that the weight of a vehicle could be reduced by 14%, with no compounding, for a cost of \$1.36 per pound. Our final cost estimate is \$1.32 per pound and is based on the average of the three referenced studies. Applying an ICM factor of 1.11 for a low complexity technology results in a compliance cost of \$1.48 per pound. For the vehicle mass reduction technologies, neither volume-based nor time-based cost reductions are applied since many of the materials under consideration are commodity based and the BOM is only loosely defined.

Lastly, the phase-in cap for MS1 in this proposal is 85 percent in MYs 2012 to 2015 and 100 percent in MY 2016, while for MS2 an 85 percent cap exists in MYs 2014 and 2015 followed by a 100 percent in MY 2016. Although a departure from the 2011 rulemaking, NHTSA believes that the proposed mass reduction technologies represent a realistic approach that effectively, and when overall application rates are considered, accurately emulates the weight reductions likely to occur in the U.S. light vehicle fleet within the rulemaking timeframe.

(27) Low Drag Brakes (LDB)

Low drag brakes reduce the sliding friction of disc brake pads on rotors when the brakes are not engaged because the brake pads are pulled away from the rotating disc either by mechanical or electric methods. While most passenger cars have already adopted this technology with the standardization of electronic brake control, there are indications that this technology is still available for body-on-frame vehicles.

NHTSA's MY 2011 CAFE final rule estimated the effectiveness of LDB to be up to 1 percent, based on confidential manufacturer data. NHTSA has reviewed this estimate and believe it to be applicable for the NPRM.

NHTSA reviewed the cost estimates from the MY 2011 CAFE final rule and determined that these estimates remain applicable for the current proposal. The agency adjusted the costs to apply the ICM indirect cost multiplier of 1.11, for a low complexity technology, instead of the 1.5 RPE factor used in the 2011 final rule. The compliance cost for LDB is therefore \$63 for a MY 2012 vehicle, and since no cost learning is applied, remains so throughout the rulemaking timeframe.

The phase-in cap for LDB in this proposal is 85 percent in MYs 2012 to 2014, and 100 percent through the remainder of the rulemaking period. The Volpe model can apply this technology at a vehicle's refresh or redesign years, and the technology is only applicable to the Large Car, Minivan, and Medium and Large Truck and SUVs since, as mentioned above, it is already largely utilized in most other subclasses.

(28) Low Rolling Resistance Tires (ROLL)

Tire rolling resistance is the frictional loss associated mainly with the energy dissipated in the deformation of the tires under load and thus influences fuel economy. Other tire design characteristics (*e.g.*, materials, construction, and tread design) influence durability, traction (both wet and dry grip), vehicle handling, and ride comfort in addition to rolling resistance. A typical low rolling resistance tire's attributes would include: increased tire inflation pressure, material changes, tire construction with less hysteresis, geometry changes (*e.g.*, reduced aspect ratios), and reduction in sidewall and tread deflection. These changes would generally be accompanied with additional changes to suspension tuning and/or suspension design. For performance vehicle classifications, due to the increased traction requirements for braking and handling which currently cannot be fully met with low rolling resistance designs, the Volpe model does not apply this technology.

NHTSA estimates a 1 to 2 percent increase in effectiveness with a 10 percent reduction in rolling resistance, which was based on the 2002 NAS report findings and consistent with the MY 2011 final rule estimate. NHTSA still believes that this NAS effectiveness estimate is valid for this NPRM.

Based on the MY 2011 CAFE final rule and the 2006 NAS/NRC report, NHTSA has estimated the cost for low rolling resistance tires to be \$6 per vehicle. This is based

on a cost of \$1 per tire as estimated by NAS/NRC 2006 report, which is \$5 per vehicle, including the spare tire. When applying the ICM low complexity markup factor of 1.11, this results in a compliance cost of \$6 per vehicle for a MY 2012 vehicle.¹⁶⁰ Lower rolling resistance tires are widely available today however, due to the commodity based nature of the materials used in tire manufacturing, cost learning is not considered applicable.

The phase-in cap for the ROLL technology in this proposal is 85 percent in MYs 2012 to 2014, and 100 percent through the remainder of the rulemaking period. Due to the need to assess any potential impacts on vehicle dynamics and braking characteristics, the Volpe model can only apply this technology at a vehicle's refresh or redesign cycle, and as noted above, the model does not apply the technology to the performance subclass vehicles due to suitability concerns.

(29) Front or Secondary Axle Disconnect for Four-Wheel Drive Systems (SAX)

Energy is required to continually drive the front, or secondary, axle in a four wheel drive system even though the system is not required during most operating conditions. This energy loss directly results in increased fuel consumption. Many part-time four-wheel drive systems use some type of front axle disconnect to provide shift-on-the-fly capabilities. The front axle disconnect is normally part of the front differential assembly. As part of a shift-on-the-fly four-wheel drive system, the front axle disconnect serves two basic purposes. First, in two-wheel-drive mode, it disengages the front axle from the front driveline so the front wheels do not turn the front driveline at road speed, saving wear and tear. Second, when shifting from two- to four-wheel drive "on the fly" (while moving), the front axle disconnect couples the front axle to the front differential side gear only when the transfer case's synchronizing mechanism has spun the front driveshaft up to the same speed as the rear driveshaft. Four-wheel drive systems that have a front axle disconnect typically do not have either manual- or automatic-locking hubs. To isolate the front wheels from the rest of the front driveline, front axle disconnects use a sliding sleeve to connect or disconnect an axle shaft from the front differential side gear. NHTSA is not aware of any manufacturer offering this technology in the U.S. today on unibody frame vehicles; however, it is possible this technology could be introduced by manufacturers within the rulemaking time period.

Based on confidential manufacturer data, the MY 2011 final rule estimated an effectiveness improvement of 1 to 1.5 percent for the SAX technology and after thorough review, NHTSA finds this to be an accurate estimate for this rulemaking.

Regarding costs, NHTSA reviewed the incremental compliance cost from the MY 2011 final rule and concluded it remains accurate. However a new ICM factor of 1.11, for a low complexity technology, replaces the 1.5 RPE markup factor used previously.

¹⁶⁰ Note that the costs developed for low rolling resistance tires for this analysis do not include the increase in lifetime costs that would be expected at each tire replacement. Instead, the analysis includes only the upfront increase in costs. The agencies intend to include the lifetime costs in the final analysis.

Thus, the compliance cost estimate for this NPRM is \$87 for MY 2012 vehicles. As the SAX technology is readily available and in use today, time based learning is considered applicable, hence the costs for later MYs will be lower.

The phase-in cap for SAX in this proposal is 85 percent in MYs 2012 to 2014, and 100 percent throughout the remainder of the rulemaking period. Due to varying vehicle architecture designs, and thus the potential complexity associated with implementing these systems, the Volpe model can only apply this technology at a vehicle's refresh or redesign years. SAX is applicable to all vehicle subclasses however an engineering constraint programmed within the Volpe model's programming code ensures the SAX technology is only applied to vehicles that have (true) four-wheel drive systems in the baseline vehicle (i.e., SAX is not applicable to all-wheel drive equipped vehicles).

(30) Aerodynamic Drag Reduction (AERO)

Many factors affect a vehicle's aerodynamic drag and the resulting power required to move it through the air. While these factors change with air density and the square and cube of vehicle speed, respectively, the overall drag effect is determined by the product of its frontal area and drag coefficient. Reductions in these quantities can therefore reduce drag and lower the vehicle's fuel consumption. Although frontal areas tend to be relatively similar within a vehicle class (mostly due to market-competitive size requirements), variations in drag coefficient can be observed. Significant changes to a vehicle's aerodynamic performance may need to be implemented during a redesign (e.g. changes in vehicle shape). However, shorter-term aerodynamic reductions, with a somewhat lower effectiveness, may be achieved through the use of revised exterior components (typically at a model refresh in mid-cycle) and add-on devices that currently being applied. The latter list would include revised front and rear fascias, modified front air dams and rear valances, addition of rear deck lips and underbody panels, and lower aerodynamic drag exterior mirrors.

The MY 2011 final rule estimated that a fleet average of 10 to 20 percent total aerodynamic drag reduction is attainable (with a caveat for "high-performance" vehicles described below) which equates to incremental reductions in fuel consumption of 2 to 3 percent for cars and trucks. These numbers are generally supported by confidential manufacturer data and public technical literature and therefore, NHTSA continues to use this estimate for this proposal.

The 2011 final rule also estimated a range from \$60 to \$116 which used a 1.5 RPE; the non-RPE costs were therefore \$40 to \$75. NHTSA and EPA reviewed the 2011 costs and concluded the estimate should be closer to the lower end of the 2011 rulemaking range. Thus, the cost estimate used in this rulemaking is \$48 (\$43 without markup), which includes a 1.11 ICM markup value for a low complexity technology. This compliance cost is for a MY 2012 vehicle and will decrease in future years due to the application of time-based learning. The AERO technology is considered to already be in use on most performance subclasses, therefore the Volpe model does not apply this technology to performance vehicles. The phase-in cap for AERO in this proposal is 85

percent in MYs 2012 to 2014, and 100 percent through the remainder of the rulemaking period. As noted above, the types of improvements envisioned in the AERO technology are suitable for application at refresh or redesign cycle.

e. Technologies considered but not included in the final rule analysis

NHTSA, in consultation with EPA, has identified five technologies that will not be available in the time frame considered under this rulemaking. These technologies while considered were not made available in the CAFE model. They are: electric vehicles (EV), camless valve actuation (CVA), lean burn gasoline direct injection (LBDI), homogeneous charge compression ignition (HCCI), and electric assist turbocharging. NHTSA will continue to monitor the industry and system suppliers for progress on these technologies, and should they become available, consider them for use in future rulemaking activity.

i. Electric Vehicles

The recent intense interest in Hybrid vehicles and the development of Hybrid vehicle battery and motor technology has helped make Electric Vehicle technology more viable than it has ever been. Electric Vehicles (EVs) require much larger batteries than either HEVs or PHEVs, but the batteries must be of a high-energy and lower-power design to deliver an appropriate amount of power over the useful charge of the battery. These high-energy batteries are generally less expensive per kilowatt-hour than high-power batteries required for hybrids, but the size of the battery pack still incurs a considerable cost.

Electric motor and power electronics designs are very similar to HEV and PHEV designs, but they must be larger, more powerful, and more robust since they provide the only motive power for the vehicle. On the other hand, the internal combustion engine, fuel system, and possibly the transmission can all be removed for significant weight, complexity and cost savings.

While a few manufactures have released public statements indicating that they are planning on producing small volumes of electric vehicles within the rulemaking time frame, the agency believes that the application of electric vehicles above and beyond these small volumes will not likely be feasible. Thus for purposes of this NPRM, NHTSA has not included electric vehicles in its analysis.

ii. Camless Valve Actuation

Camless valve actuation relies on electromechanical actuators instead of camshafts to open and close the cylinder valves. When electromechanical actuators are used to replace cams and coupled with sensors and microprocessor controls, valve timing and lift can be optimized over all conditions. An engine valvetrain that operates independently of any mechanical means provides the increased flexibility for intake and exhaust timing and lift optimization. With it comes increased ability to vary valve overlap, the rapid response required to change between combustion operating modes (such as HCCI and GDI), intake valve throttling, cylinder deactivation, and elimination

of the camshafts (reduced friction and rotating mass). This level of control can enable even further incremental reductions in fuel consumption and.

This technology has been under research for many decades and although progress is being made, NHTSA has not found evidence to support that the technology can be successfully implemented within the 2012 through 2016 timeframe of these regulations. Thus NHTSA has not estimated cost or effectiveness at this time.

iii. Lean-Burn Gasoline Direct Injection Technology

Direct injection, especially with diesel-like “spray-guided” injection systems, enables operation with excess air in a stratified or partially-stratified fuel-air mixture, as a way of reducing the amount of intake throttling. Also, with higher-pressure fuel injection systems, the fuel may be added late enough during the compression stroke so as to delay the onset of auto-ignition, even with higher engine compression ratios or with boosted intake pressure. Taken together, an optimized “lean-burn” direct injection gasoline engine may achieve high engine thermal efficiency, which approaches that of a diesel engine. European gasoline direct-injection engines have implemented stratified-charge lean-burn GDI, although at higher NO_x emissions levels than are allowed under U.S. Federal Tier 2 emissions standards. Fuel system improvements, changes in combustion chamber design and repositioning of the injectors have allowed for better air/fuel mixing and combustion efficiency. There is currently a shift from wall-guided injection to spray guided injection, which improves injection precision and targeting towards the spark plug, increasing lean combustion stability. Combined with advances in NO_x after-treatment, lean-burn GDI engines may eventually be a possibility in North America.

NHTSA’s current assessment is that the availability of ultra-low sulfur (less than 15 ppm sulfur) gasoline is a key technical requirement for lean-burn GDI engines to meet EPA’s Tier 2 NO_x emissions standards, therefore the technology was not applied in the NHTSA analysis.

iv. Homogeneous Charge Compression Ignition

Gasoline homogeneous charge compression ignition (HCCI), also referred to as controlled auto-ignition (CAI), is an alternate engine operating mode that does not rely on a spark event to initiate combustion. The principles are more closely aligned with a diesel combustion cycle, in which the compressed charge exceeds a temperature and pressure necessary for spontaneous auto-ignition although it differs from diesel by having a homogenous fuel/air charge rather than being a diffusion controlled combustion event. The subsequent combustion event is much shorter in duration with higher thermal efficiency.

An HCCI engine has inherent advantages in its overall efficiency for two main reasons:

- The engine is operated with a higher compression ratio, and with a shorter combustion duration, resulting in a higher thermodynamic efficiency, and
- The engine can be operated virtually unthrottled, even at light loads,

Combined, these effects have shown an increase in engine brake efficiency (typically 25-28%) to greater than 35% at the high end of the HCCI operating range.¹⁶¹ Criteria pollutant emissions are very favorable during HCCI operation. Lower peak in-cylinder temperatures (due to high dilution) keep engine-out NO_x emissions to a minimum – realistically below Tier 2 levels without aftertreatment – and particulates are low due to the homogeneous nature of the premixed charge. Due to the inherent difficulty in maintaining combustion stability without encountering engine knock, HCCI is difficult to control, requiring feedback from in-cylinder pressure sensors and rapid engine control logic to optimize combustion timing, especially considering the transient nature of operating conditions seen in a vehicle. Due to the highly dilute conditions under which gasoline HCCI combustion is stable, the range of engine loads achievable in a naturally-aspirated engine is somewhat limited. Because of this, it is likely that any commercial application would operate in a “dual-mode” strategy between HCCI and spark ignition combustion modes, in which HCCI would be utilized for best efficiency at light engine loads and spark ignition would be used at higher loads and at idle. This type of dual-mode strategy has already been employed in diesel HCCI engines in Europe and Asia (notably the Toyota Avensis D-Cat and the Nissan light-duty “MK” combustion diesels). Until recently, gasoline HCCI technology was considered to still be in the research phase. However, most manufacturers have made public statements about the viability of incorporating HCCI into light-duty passenger vehicles, and have significant vehicle demonstration programs aimed at producing a viable product within the next 5-10 years.

There is widespread opinion as to the fuel consumption reduction potential for HCCI in the literature. Based on confidential manufacturer information, it is believed that a gasoline HCCI / GDI dual-mode engine might achieve 10-12% reduction in fuel consumption, compared to a comparable SI engine. Despite its promise, application of HCCI in light duty vehicles is not yet ready for the market. It is not anticipated to be seen in volume for at least the next 5-10 years, which is concurrent with many manufacturers’ public estimates. As noted in MY 2011 CAFE final rule that the technology will not be available within the time frame considered based on a review of confidential product plan information.

v. Electric Assist Turbocharging

The Alliance commented in NHTSA’s previous rulemaking that global development of electric assist turbocharging has not demonstrated the fuel efficiency effectiveness of a 12V EAT up to 2kW power levels since the 2004 NESCCAF study, and stated that it saw remote probability of its application over the next decade. While hybrid vehicles lower the incremental hardware requirements for higher-voltage, higher-power EAT systems, NHTSA believes that significant developmental work is required to demonstrate effective systems and that implementation in significant volumes will not occur in the 2012 to 2016 time frame considered in this rulemaking. Thus, this technology was not included in the NPRM.

E. Cost and effectiveness tables

¹⁶¹ “An HCCI Engine Power Plant for a Hybrid Vehicle,” Sun, R., R. Thomas and C. Gray, Jr., SAE Technical Paper No. 2004-01-0933, 2004.

The tables representing the Volpe model input files for incremental technology costs by vehicle subclass are presented below. The tables have been divided into passenger cars, performance passenger cars, and light trucks to make them easier to read.

Table V-33 Technology Incremental Cost Estimates, Passenger Cars

VEHICLE TECHNOLOGY ICM COSTS PER VEHICLE (2007\$) BY VEHICLE SUBCLASS - PASSENGER CARS					
		Subcompact Car	Compact Car	Midsize Car	Large Car
Nominal Baseline Engine (For Cost Basis)		Inline 4	Inline 4	Inline 4	V6
Low Friction Lubricants		3	3	3	3
Engine Friction Reduction	EFR	50	50	50	75
VVT - Coupled Cam Phasing (CCP) on SOHC	CCPS	45	45	45	90
Discrete Variable Valve Lift (DVVL) on SOHC	DVVLS	142	142	142	205
Cylinder Deactivation on SOHC	DEACS	n.a.	n.a.	n.a.	0 - 56
VVT - Intake Cam Phasing (ICP)	ICP	45	45	45	90
VVT - Dual Cam Phasing (DCP)	DCP	38	38	38	83
Discrete Variable Valve Lift (DVVL) on DOHC	DVVLD	142	142	142	205
Continuously Variable Valve Lift (CVVL)	CVVL	277	277	277	509
Cylinder Deactivation on DOHC	DEACD	n.a.	n.a.	n.a.	0 - 56
Cylinder Deactivation on OHV	DEACO	n.a.	n.a.	n.a.	170
VVT - Coupled Cam Phasing (CCP) on OHV	CCPO	45	45	45	45
Discrete Variable Valve Lift (DVVL) on OHV	DVVLO	142	142	142	0 - 56
Conversion to DOHC with DCP	CDOHC	276	276	276	436
Stoichiometric Gasoline Direct Injection (GDI)	SGDI	251	251	251	326
Combustion Restart	CBRST	118	118	118	118
Turbocharging and Downsizing	TRBDS	644	644	644	512
Exhaust Gas Recirculation (EGR) Boost	EGRB	144	144	144	144
Conversion to Diesel following CBRST	DSLCL	n.a.	n.a.	n.a.	1,572 - 1,627
Conversion to Diesel following TRBDS	DSLTL	n.a.	n.a.	n.a.	916 - 971
6-Speed Manual/Improved Internals	6MAN	250	250	250	250
Improved Auto. Trans. Controls/Externals	IATC	60	60	60	60
Continuously Variable Transmission	CVT	250	250	250	250
6/7/8-Speed Auto. Trans with Improved Internals	NAUTO	170	170	170	170
Dual Clutch or Automated Manual Transmission	DCTAM	73	73	158	158
Electric Power Steering	EPS	106	106	106	106
Improved Accessories	IACC	128	128	128	128
12V Micro-Hybrid	MHEV	288	311	342	367
Belt mounted Integrated Starter Generator	BISG	286	286	286	286
Crank mounted Integrated Starter Generator	CISG	2,791	3,107	3,319	3,547
Power Split Hybrid	PSHEV	1,600	2,133	2,742	3,261
2-Mode Hybrid	2MHEV	n.a.	n.a.	n.a.	n.a.
Plug-in Hybrid	PHEV	11,520 - 11,527	14,135 - 14,142	16,136 - 16,215	n.a.
Mass Reduction (1.5%)	MS1	1.5	1.5	1.5	1.5
Mass Reduction (3.5 to 8.5%)	MS2	1.5	1.5	1.5	1.5
Low Rolling Resistance Tires	ROLL	6	6	6	6

Low Drag Brakes	LDB	n.a.	n.a.	n.a.	63
Secondary Axle Disconnect	SAX	87	87	87	87
Aero Drag Reduction	AERO	48	48	48	48

Table V-34 Technology Incremental Cost Estimates, Performance Passenger Cars

VEHICLE TECHNOLOGY ICM COSTS PER VEHICLE (2007\$) BY VEHICLE SUBCLASS - PERFORMANCE PASSENGER CARS					
		Perform. Subcomp. Car	Perform. Compact Car	Perform. Midsize Car	Perform. Large Car
Nominal Baseline Engine (For Cost Basis)		Inline 4	V6	V6	V8
Low Friction Lubricants	LUB	3	3	3	3
Engine Friction Reduction	EFR	50	75	75	101
VVT - Coupled Cam Phasing (CCP) on SOHC	CCPS	45	90	90	90
Discrete Variable Valve Lift (DVVL) on SOHC	DVVLS	142	205	205	293
Cylinder Deactivation on SOHC	DEACS	n.a.	0 - 56	0 - 56	0 - 56
VVT - Intake Cam Phasing (ICP)	ICP	45	90	90	90
VVT - Dual Cam Phasing (DCP)	DCP	38	83	83	82
Discrete Variable Valve Lift (DVVL) on DOHC	DVVLD	142	205	205	293
Continuously Variable Valve Lift (CVVL)	CVVL	277	509	509	555
Cylinder Deactivation on DOHC	DEACD	n.a.	0 - 56	0 - 56	0 - 56
Cylinder Deactivation on OHV	DEACO	n.a.	170	170	190
VVT - Coupled Cam Phasing (CCP) on OHV	CCPO	45	45	45	45
Discrete Variable Valve Lift (DVVL) on OHV	DVVLO	142	0 - 56	0 - 56	0 - 56
Conversion to DOHC with DCP	CDOHC	276	436	436	552
Stoichiometric Gasoline Direct Injection (GDI)	SGDI	251	326	326	353
Combustion Restart	CBRST	118	118	118	118
Turbocharging and Downsizing	TRBDS	644	512	512	1,098
Exhaust Gas Recirculation (EGR) Boost	EGRB	144	144	144	144
Conversion to Diesel following CBRST	DSLCL	n.a.	1,572 - 1,627	1,572 - 1,627	2,331 - 2,377
Conversion to Diesel following TRBDS	DSLTL	n.a.	916 - 971	916 - 971	1,090 - 1,145
6-Speed Manual/Improved Internals	6MAN	250	250	250	250
Improved Auto. Trans. Controls/Externals	IATC	60	60	60	60
Continuously Variable Transmission	CVT	250	250	250	250
6/7/8-Speed Auto. Trans with Improved Internals	NAUTO	170 - 272	170 - 272	170 - 272	170 - 272
Dual Clutch or Automated Manual Transmission	DCTAM	73	158	158	158
Electric Power Steering	EPS	106	106	106	106
Improved Accessories	IACC	128	128	128	128
12V Micro-Hybrid	MHEV	314	372	372	410
Belt mounted Integrated Starter Generator	BISG	286	286	286	286
Crank mounted Integrated Starter Generator	CISG	2,839	3,335	3,149	3,571
Power Split Hybrid	PSHEV	3,661	5,106 - 5,287	3,838 - 4,018	6,543 - 6,723
2-Mode Hybrid	2MHEV	n.a.	n.a.	n.a.	n.a.
Plug-in Hybrid	PHEV	14,891 - 14,993	19,085 - 19,265	16,612 - 16,714	n.a.
Mass Reduction (1.5%)	MS1	1.5	1.5	1.5	1.5
Mass Reduction (3.5 to 8.5%)	MS2	1.5	1.5	1.5	1.5
Low Rolling Resistance Tires	ROLL	n.a.	n.a.	n.a.	n.a.

Low Drag Brakes	LDB	n.a.	n.a.	n.a.	63
Secondary Axle Disconnect	SAX	87	87	87	87
Aero Drag Reduction	AERO	n.a.	n.a.	n.a.	n.a.

Table V-35 Technology Incremental Cost Estimates, Light Trucks

VEHICLE TECHNOLOGY ICM COSTS PER VEHICLE (2007\$) BY VEHICLE SUBCLASS - LIGHT TRUCKS					
		Minivan LT	Small LT	Midsize LT	Large LT
Nominal Baseline Engine (For Cost Basis)		V6	Inline 4	V6	V8
Low Friction Lubricants	LUB	3	3	3	3
Engine Friction Reduction	EFR	75	50	75	101
VVT - Coupled Cam Phasing (CCP) on SOHC	CCPS	90	45	90	90
Discrete Variable Valve Lift (DVVL) on SOHC	DVVLS	205	142	205	293
Cylinder Deactivation on SOHC	DEACS	0 - 56	n.a.	0 - 56	0 - 56
VVT - Intake Cam Phasing (ICP)	ICP	90	45	90	90
VVT - Dual Cam Phasing (DCP)	DCP	83	38	83	83
Discrete Variable Valve Lift (DVVL) on DOHC	DVVLD	205	142	205	293
Continuously Variable Valve Lift (CVVL)	CVVL	509	277	509	555
Cylinder Deactivation on DOHC	DEACD	0 - 56	n.a.	0 - 56	0 - 56
Cylinder Deactivation on OHV	DEACO	170	n.a.	170	190
VVT - Coupled Cam Phasing (CCP) on OHV	CCPO	45	45	45	45
Discrete Variable Valve Lift (DVVL) on OHV	DVVLO	0 - 56	142	0 - 56	0 - 56
Conversion to DOHC with DCP	CDOHC	436	276	436	552
Stoichiometric Gasoline Direct Injection (GDI)	SGDI	326	251	326	353
Combustion Restart	CBRST	118	118	118	118
Turbocharging and Downsizing	TRBDS	512	644	512	1,098
Exhaust Gas Recirculation (EGR) Boost	EGRB	144	144	144	144
Conversion to Diesel following CBRST	DSL	1,572 - 1,627	n.a.	1,572 - 1,627	2,331 - 2,387
Conversion to Diesel following TRBDS	DSL	916 - 971	n.a.	916 - 971	1,090 - 1,145
6-Speed Manual/Improved Internals	6MAN	250	250	250	250
Improved Auto. Trans. Controls/Externals	IATC	60	60	60	60
Continuously Variable Transmission	CVT	250	250	250	250
6/7/8-Speed Auto. Trans with Improved Internals	NAUTO	170	170	170 - 272	170 - 272
Dual Clutch or Automated Manual Transmission	DCTAM	158	73	158	158
Electric Power Steering	EPS	106	106	106	106
Improved Accessories	IACC	128	128	128	n.a.
12V Micro-Hybrid	MHEV	367	325	376	n.a.
Belt mounted Integrated Starter Generator	BISG	286	286	286	n.a.
Crank mounted Integrated Starter Generator	CISG	3,547	3,141	3,611	5,124
Power Split Hybrid	PSHEV	3,261	2,377 - 2,384	3,282 - 3,462	n.a.
2-Mode Hybrid	2MHEV	n.a.	3,521	4,663 - 4,764	5,678 - 5,779
Plug-in Hybrid	PHEV	n.a.	14,589	n.a.	n.a.
Mass Reduction (1.5%)	MS1	1.5	1.5	1.5	1.5
Mass Reduction (3.5 to 8.5%)	MS2	1	1.5	1.5	1.5
Low Rolling Resistance Tires	ROLL	6	6	6	6

Low Drag Brakes	LDB	63	n.a.	63	63
Secondary Axle Disconnect	SAX	87	87	87	87
Aero Drag Reduction	AERO	48	48	48	48

The tables representing the Volpe model input files for incremental technology effectiveness values by vehicle subclass are presented below. The tables have been divided into passenger cars, performance passenger cars, and light trucks to make them easier to read.

Table V-36 Technology Incremental Effectiveness Estimates, Passenger Cars

VEHICLE TECHNOLOGY INCREMENTAL FUEL CONSUMPTION REDUCTION (-%) BY VEHICLE SUBCLASS - PASSENGER CAR					
		Subcompact Car	Compact Car	Midsize Car	Large Car
Nominal Baseline Engine (For Cost Basis)		Inline 4	Inline 4	Inline 4	V6
Low Friction Lubricants	LUB	0.5	0.5	0.5	0.5
Engine Friction Reduction	EFR	1.0 - 2.0	1.0 - 2.0	1.0 - 2.0	1.0 - 2.0
VVT - Coupled Cam Phasing (CCP) on SOHC	CCPS	1.0 - 3.0	1.0 - 3.0	1.0 - 3.0	1.0 - 3.0
Discrete Variable Valve Lift (DVVL) on SOHC	DVVLS	1.0 - 3.0	1.0 - 3.0	1.0 - 3.0	1.0 - 3.0
Cylinder Deactivation on SOHC	DEACS	n.a.	n.a.	n.a.	2.5 - 3.0
VVT - Intake Cam Phasing (ICP)	ICP	1.0 - 2.0	1.0 - 2.0	1.0 - 2.0	1.0 - 2.0
VVT - Dual Cam Phasing (DCP)	DCP	2.0 - 3.0	2.0 - 3.0	2.0 - 3.0	2.0 - 3.0
Discrete Variable Valve Lift (DVVL) on DOHC	DVVLD	1.0 - 3.0	1.0 - 3.0	1.0 - 3.0	1.0 - 3.0
Continuously Variable Valve Lift (CVVL)	CVVL	1.5 - 3.5	1.5 - 3.5	1.5 - 3.5	1.5 - 3.5
Cylinder Deactivation on DOHC	DEACD	n.a.	n.a.	n.a.	0 - 0.5
Cylinder Deactivation on OHV	DEACO	n.a.	n.a.	n.a.	3.9 - 5.5
VVT - Coupled Cam Phasing (CCP) on OHV	CCPO	1.0 - 1.5	1.0 - 1.5	1.0 - 1.5	1.0 - 1.5
Discrete Variable Valve Lift (DVVL) on OHV	DVVLO	0.5 - 2.5	0.5 - 2.5	0.5 - 2.5	0.5 - 2.5
Conversion to DOHC with DCP	CDOHC	1.0 - 2.5	1.0 - 2.5	1.0 - 2.5	1.0 - 2.5
Stoichiometric Gasoline Direct Injection (GDI)	SGDI	2.0 - 3.0	2.0 - 3.0	2.0 - 3.0	2.0 - 3.0
Combustion Restart	CBRST	2.0 - 2.5	2.0 - 2.5	2.0 - 2.5	2.0 - 2.5
Turbocharging and Downsizing	TRBDS	4.2 - 4.8	4.2 - 4.8	4.2 - 4.8	1.8 - 1.9
Exhaust Gas Recirculation (EGR) Boost	EGRB	3.5 - 4.0	3.5 - 4.0	3.5 - 4.0	3.5 - 4.0
Conversion to Diesel following CBRST	DSLCL	n.a.	n.a.	n.a.	10.8 - 11.7
Conversion to Diesel following TRBDS	DSLTL	n.a.	n.a.	n.a.	5.3 - 6.9
6-Speed Manual/Improved Internals	6MAN	0.5	0.5	0.5	0.5
Improved Auto. Trans. Controls/Externals	IATC	1.5 - 2.5	1.5 - 2.5	1.5 - 2.5	1.5 - 2.5
Continuously Variable Transmission	CVT	0.7 - 2.0	0.7 - 2.0	0.7 - 2.0	0.7 - 2.0
6/7/8-Speed Auto. Trans with Improved Internals	NAUTO	1.4 - 3.4	1.4 - 3.4	1.4 - 3.4	1.4 - 3.4
Dual Clutch or Automated Manual Transmission	DCTAM	2.7 - 4.1	2.7 - 4.1	2.7 - 4.1	2.7 - 4.1
Electric Power Steering	EPS	1.0 - 2.0	1.0 - 2.0	1.0 - 2.0	1.0 - 2.0
Improved Accessories	IACC	1.0 - 2.0	1.0 - 2.0	1.0 - 2.0	1.0 - 2.0
12V Micro-Hybrid	MHEV	2.0 - 3.0	2.0 - 3.0	2.0 - 3.0	2.5 - 3.5
Belt mounted Integrated Starter Generator	BISG	4.0 - 6.0	4.0 - 6.0	4.0 - 6.0	3.5 - 5.5
Crank mounted Integrated Starter Generator	CISG	8.6 - 8.9	8.6 - 8.9	8.6 - 8.9	8.7 - 8.9
Power Split Hybrid	PSHEV	6.3 - 12.4	6.3 - 12.4	6.3 - 12.4	6.3 - 12.4

2-Mode Hybrid	2MHEV	n.a.	n.a.	n.a.	n.a.
Plug-in Hybrid	PHEV	45.2 - 47.7	45.2 - 47.7	45.2 - 47.7	n.a.
Mass Reduction (1.5%)	MS1	1.0	1.0	1.0	1.0
Mass Reduction (3.5 to 8.5%)	MS2	2.3	2.3	3.9	5.6
Low Rolling Resistance Tires	ROLL	1.0 - 2.0	1.0 - 2.0	1.0 - 2.0	1.0 - 2.0
Low Drag Brakes	LDB	n.a.	n.a.	n.a.	0.5 - 1.0
Secondary Axle Disconnect	SAX	1.0 - 1.5	1.0 - 1.5	1.0 - 1.5	1.0 - 1.5
Aero Drag Reduction	AERO	2.0 - 3.0	2.0 - 3.0	2.0 - 3.0	2.0 - 3.0

**Table V-37 Technology Incremental Effectiveness Estimates,
Performance Cars**

VEHICLE TECHNOLOGY INCREMENTAL FUEL CONSUMPTION REDUCTION (-%) BY VEHICLE SUBCLASS - PERFORMANCE PASSENGER CAR					
		Perform. Subcomp. Car	Perform. Compact Car	Perform. Midsize Car	Perform. Large Car
Nominal Baseline Engine (For Cost Basis)		Inline 4	V6	V6	V8
Low Friction Lubricants	LUB	0.5	0.5	0.5	0.5
Engine Friction Reduction	EFR	1.0 - 2.0	1.0 - 2.0	1.0 - 2.0	1.0 - 2.0
VVT - Coupled Cam Phasing (CCP) on SOHC	CCPS	1.0 - 3.0	1.0 - 3.0	1.0 - 3.0	1.0 - 3.0
Discrete Variable Valve Lift (DVVL) on SOHC	DVVLS	1.0 - 3.0	1.0 - 3.0	1.0 - 3.0	1.0 - 3.0
Cylinder Deactivation on SOHC	DEACS	n.a.	2.5 - 3.0	2.5 - 3.0	2.5 - 3.0
VVT - Intake Cam Phasing (ICP)	ICP	1.0 - 2.0	1.0 - 2.0	1.0 - 2.0	1.0 - 2.0
VVT - Dual Cam Phasing (DCP)	DCP	2.0 - 3.0	2.0 - 3.0	2.0 - 3.0	2.0 - 3.0
Discrete Variable Valve Lift (DVVL) on DOHC	DVVLD	1.0 - 3.0	1.0 - 3.0	1.0 - 3.0	1.0 - 3.0
Continuously Variable Valve Lift (CVVL)	CVVL	1.5 - 3.5	1.5 - 3.5	1.5 - 3.5	1.5 - 3.5
Cylinder Deactivation on DOHC	DEACD	n.a.	0.0 - 0.5	0.0 - 0.5	0.0 - 0.5
Cylinder Deactivation on OHV	DEACO	n.a.	3.9 - 5.5	3.9 - 5.5	3.9 - 5.5
VVT - Coupled Cam Phasing (CCP) on OHV	CCPO	1.0 - 1.5	1.0 - 1.5	1.0 - 1.5	1.0 - 1.5
Discrete Variable Valve Lift (DVVL) on OHV	DVVLO	0.5 - 2.5	0.5 - 2.5	0.5 - 2.5	0.5 - 2.5
Conversion to DOHC with DCP	CDOHC	1.0 - 2.5	1.0 - 2.5	1.0 - 2.5	1.0 - 2.5
Stoichiometric Gasoline Direct Injection (GDI)	SGDI	2.0 - 3.0	2.0 - 3.0	2.0 - 3.0	2.0 - 3.0
Combustion Restart	CBRST	2.0 - 2.5	2.0 - 2.5	2.0 - 2.5	2.0 - 2.5
Turbocharging and Downsizing	TRBDS	4.2 - 4.8	1.8 - 1.9	1.8 - 1.9	1.8 - 1.9
Exhaust Gas Recirculation (EGR) Boost	EGRB	3.5 - 4.0	3.5 - 4.0	3.5 - 4.0	3.5 - 4.0
Conversion to Diesel following CBRST	DSLCL	n.a.	10.8 - 11.7	10.8 - 11.7	10.8 - 11.7
Conversion to Diesel following TRBDS	DSLTL	n.a.	5.3 - 6.9	5.3 - 6.9	5.3 - 6.9
6-Speed Manual/Improved Internals	6MAN	0.5	0.5	0.5	0.5
Improved Auto. Trans. Controls/Externals	IATC	1.5 - 2.5	1.5 - 2.5	1.5 - 2.5	1.5 - 2.5
Continuously Variable Transmission	CVT	0.7 - 2.0	0.7 - 2.0	0.7 - 2.0	n.a.
6/7/8-Speed Auto. Trans with Improved Internals	NAUTO	1.4 - 3.4	1.4 - 3.4	1.4 - 3.4	1.4 - 3.4
Dual Clutch or Automated Manual Transmission	DCTAM	2.7 - 4.1	2.7 - 4.1	2.7 - 4.1	2.7 - 4.1
Electric Power Steering	EPS	1.0 - 2.0	1.0 - 2.0	1.0 - 2.0	1.0 - 2.0
Improved Accessories	IACC	1.0 - 2.0	1.0 - 2.0	1.0 - 2.0	1.0 - 2.0
12V Micro-Hybrid	MHEV	2.0 - 3.0	2.5 - 3.5	2.5 - 3.5	3.0 - 4.0
Belt mounted Integrated Starter Generator	BISG	4.0 - 6.0	3.5 - 5.5	3.5 - 5.5	3.0 - 5.0
Crank mounted Integrated Starter Generator	CISG	8.6 - 8.9	8.7 - 8.9	8.7 - 8.9	8.7 - 8.9
Power Split Hybrid	PSHEV	6.3 - 12.4	6.3 - 12.4	6.3 - 12.4	6.3 - 12.4

2-Mode Hybrid	2MHEV	n.a.	n.a.	n.a.	n.a.
Plug-in Hybrid	PHEV	45.2 - 47.7	45.2 - 47.7	45.2 - 47.7	n.a.
Mass Reduction (1.5%)	MS1	1.0	1.0	1.0	1.0
Mass Reduction (3.5 to 8.5%)	MS2	2.3	2.3	3.9	5.6
Low Rolling Resistance Tires	ROLL	n.a.	n.a.	n.a.	n.a.
Low Drag Brakes	LDB	n.a.	n.a.	n.a.	0.5 - 1.0
Secondary Axle Disconnect	SAX	1.0 - 1.5	1.0 - 1.5	1.0 - 1.5	1.0 - 1.5
Aero Drag Reduction	AERO	n.a.	n.a.	n.a.	n.a.

Table V-38 Technology Incremental Effectiveness Estimates, Light Trucks

VEHICLE TECHNOLOGY INCREMENTAL FUEL CONSUMPTION REDUCTION (-%) BY VEHICLE SUBCLASS - LIGHT TRUCKS					
		Minivan LT	Small LT	Midsize LT	Large LT
Nominal Baseline Engine (For Cost Basis)		V6	Inline 4	V6	V8
Low Friction Lubricants	LUB	0.5	0.5	0.5	0.5
Engine Friction Reduction	EFR	1.0 - 2.0	1.0 - 2.0	1.0 - 2.0	1.0 - 2.0
VVT - Coupled Cam Phasing (CCP) on SOHC	CCPS	1.0 - 3.0	1.0 - 3.0	1.0 - 3.0	1.0 - 3.0
Discrete Variable Valve Lift (DVVL) on SOHC	DVVLS	1.0 - 3.0	1.0 - 3.0	1.0 - 3.0	1.0 - 3.0
Cylinder Deactivation on SOHC	DEACS	2.5 - 3.0	n.a.	2.5 - 3.0	2.5 - 3.0
VVT - Intake Cam Phasing (ICP)	ICP	1.0 - 2.0	1.0 - 2.0	1.0 - 2.0	1.0 - 2.0
VVT - Dual Cam Phasing (DCP)	DCP	2.0 - 3.0	2.0 - 3.0	2.0 - 3.0	2.0 - 3.0
Discrete Variable Valve Lift (DVVL) on DOHC	DVVLD	1.0 - 3.0	1.0 - 3.0	1.0 - 3.0	1.0 - 3.0
Continuously Variable Valve Lift (CVVL)	CVVL	1.5 - 3.5	1.5 - 3.5	1.5 - 3.5	1.5 - 3.5
Cylinder Deactivation on DOHC	DEACD	0 - 0.5	n.a.	0.0 - 0.5	0.0 - 0.5
Cylinder Deactivation on OHV	DEACO	3.9 - 5.5	n.a.	3.9 - 5.5	3.9 - 5.5
VVT - Coupled Cam Phasing (CCP) on OHV	CCPO	1.0 - 1.5	1.0 - 1.5	1.0 - 1.5	1.0 - 1.5
Discrete Variable Valve Lift (DVVL) on OHV	DVVLO	0.5 - 2.5	0.5 - 2.5	0.5 - 2.5	0.5 - 2.5
Conversion to DOHC with DCP	CDOHC	1.0 - 2.5	1.0 - 2.5	1.0 - 2.5	1.0 - 2.5
Stoichiometric Gasoline Direct Injection (GDI)	SGDI	2.0 - 3.0	2.0 - 3.0	2.0 - 3.0	2.0 - 3.0
Combustion Restart	CBRST	2.0 - 2.5	2.0 - 2.5	2.0 - 2.5	2.0 - 2.5
Turbocharging and Downsizing	TRBDS	1.8 - 1.9	4.2 - 4.8	1.8 - 1.9	1.8 - 1.9
Exhaust Gas Recirculation (EGR) Boost	EGRB	3.5 - 4.0	3.5 - 4.0	3.5 - 4.0	3.5 - 4.0
Conversion to Diesel following CBRST	DSLCL	10.8 - 11.7	n.a.	10.8 - 11.7	10.8 - 11.7
Conversion to Diesel following TRBDS	DSLTL	5.3 - 6.9	n.a.	5.3 - 6.9	5.3 - 6.9
6-Speed Manual/Improved Internals	6MAN	0.5	0.5	0.5	0.5
Improved Auto. Trans. Controls/Externals	IATC	1.5 - 2.5	1.5 - 2.5	1.5 - 2.5	1.5 - 2.5
Continuously Variable Transmission	CVT	0.7 - 2.0	0.7 - 2.0	0.7 - 2.0	n.a.
6/7/8-Speed Auto. Trans with Improved Internals	NAUTO	1.4 - 3.4	1.4 - 3.4	1.4 - 3.4	1.4 - 3.4
Dual Clutch or Automated Manual Transmission	DCTAM	2.7 - 4.1	2.7 - 4.1	2.7 - 4.1	2.7 - 4.1
Electric Power Steering	EPS	1.0 - 2.0	1.0 - 2.0	1.0 - 2.0	1.0 - 2.0
Improved Accessories	IACC	1.0 - 2.0	1.0 - 2.0	1.0 - 2.0	n.a.
12V Micro-Hybrid	MHEV	2.5 - 3.5	2.0 - 3.0	2.5 - 3.5	n.a.
Belt mounted Integrated Starter Generator	BISG	3.5 - 5.5	4.0 - 6.0	3.5 - 5.5	n.a.
Crank mounted Integrated Starter Generator	CISG	8.7 - 8.9	8.6 - 8.9	8.7 - 8.9	14.1 - 16.3
Power Split Hybrid	PSHEV	6.3 - 12.4	6.3 - 12.4	6.3 - 12.4	n.a.

2-Mode Hybrid	2MHEV	n.a.	3.0 - 7.3	3.0 - 7.2	4.1 - 9.5
Plug-in Hybrid	PHEV	n.a.	45.2 - 47.7	n.a.	n.a.
Mass Reduction (1.5%)	MS1	1.0	1.0	1.0	1.0
Mass Reduction (3.5 to 8.5%)	MS2	5.6	3.9	3.9	5.6
Low Rolling Resistance Tires	ROLL	1.0 - 2.0	1.0 - 2.0	1.0 - 2.0	1.0 - 2.0
Low Drag Brakes	LDB	0.5 - 1.0	n.a.	0.5 - 1.0	0.5 - 1.0
Secondary Axle Disconnect	SAX	1.0 - 1.5	1.0 - 1.5	1.0 - 1.5	1.0 - 1.5
Aero Drag Reduction	AERO	2.0 - 3.0	2.0 - 3.0	2.0 - 3.0	2.0 - 3.0

The tables representing the Volpe model input files for approximate net (accumulated) technology costs by vehicle subclass are presented below. The tables have been divided into passenger cars, performance passenger cars, and light trucks to make them easier to read.

Table V-39 Approximate Net (Accumulated) Technology Costs, Passenger Cars

APPROXIMATE ICM NET COSTS PER VEHICLE (\$) BY VEHICLE CLASS TO KEY TECHNOLOGIES (Rounded to nearest \$100)				
Final technology (As compared to baseline vehicle prior to technology application)	Subcompact Car	Compact Car	Midsize Car	Large Car
Stoichiometric Gasoline Direct Injection (SGDI)	500 - 700	500 - 700	500 - 700	600 - 1,100
Turbocharging and Downsizing (TRBDS)	1,100 - 1,300	1,100 - 1,300	1,100 - 1,300	1,100 - 1,700
Diesel Engine (DSL/DSL/C)	n.a.	n.a.	n.a.	2,400
Dual Clutch or Automated Manual Transmission (DCTAM)	300	300	400	400
Crankshaft Integrated Starter Generator (CISG)	3,600	4,000	4,200	
Power Split Hybrid (PSHEV)	5,500	6,400	7,200	8,000
2-Mode Hybrid (2MHEV)	n.a.	n.a.	n.a.	n.a.
Plug-in Hybrid (PHEV)	15,000	18,400	20,700	n.a.

Table V-40 Approximate Net (Accumulated) Technology Costs, Performance Passenger Cars

APPROXIMATE ICM NET COSTS PER VEHICLE (\$) BY VEHICLE CLASS TO KEY TECHNOLOGIES (Rounded to nearest \$100)				
Final technology (As compared to baseline vehicle prior to technology application)	Subcompact Perf Car	Compact Perf Car	Midsize Perf Car	Large Perf Car
Stoichiometric Gasoline Direct Injection (SGDI)	500 - 700	600 - 1100	600 - 1100	700 - 1200
Turbocharging and Downsizing (TRBDS)	1100 - 1300	1100 - 1700	1100 - 1700	1700 - 2100
Diesel Engine (DSL/DSL/C)	n.a.	2,400	2,400	3,300
Dual Clutch or Automated Manual Transmission (DCTAM)	300 - 400	400 - 500	400 - 500	400 - 500
Crankshaft Integrated Starter Generator (CISG)	3,700	4,200	4,000	4,500
Power Split Hybrid (PSHEV)	7,600	9,800	8,300	11,500
2-Mode Hybrid (2MHEV)	n.a.	n.a.	n.a.	n.a.
Plug-in Hybrid (PHEV)	19,000	23,800	21,000	n.a.

Table V-41 Approximate Net (Accumulated) Technology Costs, Light Trucks

APPROXIMATE ICM NET COSTS PER VEHICLE (\$) BY VEHICLE CLASS TO KEY TECHNOLOGIES (Rounded to nearest \$100)				
Final technology (As compared to baseline vehicle prior to technology application)	Minivan LT	Small LT	Midsize LT	Large LT
Stoichiometric Gasoline Direct Injection (SGDI)	600 - 1,100	500 - 700	600 - 1,100	700 - 1,200
Turbocharging and Downsizing (TRBDS)	1,100 - 1,700	1,100 - 1,300	1,100 - 1,700	1,700 - 2,100
Diesel Engine (DSL/DSL/C)	2,400	n.a.	2,400	3,300
Dual Clutch or Automated Manual Transmission (DCTAM)	400	300	400 - 500	400 - 500
Crankshaft Integrated Starter Generator (CISG)	4,400	4,000	4,500	5,200
Power Split Hybrid (PSHEV)	8,000	6,700	8,300	n.a.
2-Mode Hybrid (2MHEV)	n.a.	7,800	9,700	11,500
Plug-in Hybrid (PHEV)	n.a.	18,900	23,800	n.a.

The tables representing the Volpe model input files for approximate net (accumulated) technology effectiveness values by vehicle subclass are presented below. The tables have been

divided into passenger cars, performance passenger cars, and light trucks to make them easier to read.

Table V-42 Approximate Net Technology Effectiveness, Passenger Cars

APPROXIMATE NET EFFECTIVENESS ESTIMATES (FC REDUCTION) PER VEHICLE (-%) BY VEHICLE CLASS TO KEY TECHNOLOGIES (Rounded to nearest 0.5%)				
Final technology (As compared to baseline vehicle prior to technology application)	Subcompact Car	Compact Car	Midsize Car	Large Car
Stoichiometric Gasoline Direct Injection (SGDI)	5.0 - 13.0	5.0 - 13.0	5.0 - 13.0	7.0 - 14.0
Turbocharging and Downsizing (TRBDS)	11.0 - 17.5	11.0 - 17.5	11.0 - 17.5	11.0 - 17.5
Diesel Engine (DSL/DSL/C)	n.a.	n.a.	n.a.	20.0 - 25.0
Dual Clutch or Automated Manual Transmission (DCTAM)	5.5 - 10.0	5.5 - 10.0	5.5 - 10.0	5.5 - 10.0
Crankshaft Integrated Starter Generator (CISG)	16.0 - 20.0	16.0 - 20.0	16.0 - 20.0	16.0 - 20.0
Power Split Hybrid (PSHEV)	23.0 - 33.0	23.0 - 33.0	23.0 - 33.0	23.0 - 33.0
2-Mode Hybrid (2MHEV)	n.a.	n.a.	n.a.	n.a.
Plug-in Hybrid (PHEV)	55.0 - 60.0	55.0 - 60.0	55.0 - 60.0	n.a.

Table V-43 Approximate Net Technology Effectiveness, Performance Passenger Cars

APPROXIMATE NET EFFECTIVENESS ESTIMATES (FC REDUCTION) PER VEHICLE (-%) BY VEHICLE CLASS TO KEY TECHNOLOGIES (Rounded to nearest 0.5%)				
Final technology (As compared to baseline vehicle prior to technology application)	Subcompact Perf Car	Compact Perf Car	Midsize Perf Car	Large Perf Car
Stoichiometric Gasoline Direct Injection (SGDI)	5.0 - 13.0	7.0 - 14.0	7.0 - 14.0	7.0 - 14.0
Turbocharging and Downsizing (TRBDS)	11.0 - 17.5	11.0 - 17.5	11.0 - 17.5	11.0 - 17.5
Diesel Engine (DSL/DSL/C)	n.a.	20.0 - 25.0	20.0 - 25.0	20.0 - 25.0
Dual Clutch or Automated Manual Transmission (DCTAM)	5.5 - 10.0	5.5 - 10.0	5.5 - 10.0	5.5 - 10.0
Crankshaft Integrated Starter Generator (CISG)	16.0 - 20.0	16.0 - 20.0	16.0 - 20.0	16.0 - 20.0
Power Split Hybrid (PSHEV)	23.0 - 33.0	23.0 - 33.0	23.0 - 33.0	23.0 - 33.0
2-Mode Hybrid (2MHEV)	n.a.	n.a.	n.a.	n.a.
Plug-in Hybrid (PHEV)	55.0 - 60.0	55.0 - 60.0	55.0 - 60.0	n.a.

Table V-44 Approximate Net Technology Effectiveness, Light Trucks

APPROXIMATE NET EFFECTIVENESS ESTIMATES (FC REDUCTION) PER VEHICLE (-%) BY VEHICLE CLASS TO KEY TECHNOLOGIES (Rounded to nearest 0.5%)				
Final technology (As compared to baseline vehicle prior to technology application)	Minivan LT	Small LT	Midsize LT	Large LT
Stoichiometric Gasoline Direct Injection (SGDI)	7.0 - 14.0	5.0 - 13.0	7.0 - 14.0	7.0 - 14.0
Turbocharging and Downsizing (TRBDS)	11.0 - 17.5	11.0 - 17.5	11.0 - 17.5	11.0 - 17.5
Diesel Engine (DSL/DSL/C)	20.0 - 25.0	n.a.	20.0 - 25.0	20.0 - 25.0
Dual Clutch or Automated Manual Transmission (DCTAM)	5.5 - 10.0	5.5 - 10.0	5.5 - 10.0	5.5 - 10.0
Crankshaft Integrated Starter Generator (CISG)	16.0 - 20.0	16.0 - 20.0	16.0 - 20.0	15.0 - 18.0
Power Split Hybrid (PSHEV)	23.0 - 33.0	23.0 - 33.0	23.0 - 33.0	n.a.
2-Mode Hybrid (2MHEV)	n.a.	23.0 - 33.0	23.0 - 33.0	23.0 - 33.0
Plug-in Hybrid (PHEV)	n.a.	55.0 - 60.0	55.0 - 60.0	n.a.

C. Penetration of Technologies by Alternative

Tables V-45 shows the penetration of technologies by alternative for passenger cars and Tables V-46 shows the penetration of technologies for light trucks for the alternatives. These tables are for the whole fleet combined, not by specific manufacturers. The application rate only includes technologies that the model applied. The penetration rate includes technologies that the model applies and technologies that were already present in the base fleet/base vehicle. They allow the reader to see the progression of technologies used as the alternatives get stricter.

Table V-45
Penetration Rate of New Technologies to Passenger Cars, by Alternative

Preferred Alternative

Technology	MY 2012	MY 2013	MY 2014	MY 2015	MY 2016
Low Friction Lubricants	80%	79%	80%	95%	95%
Engine Friction Reduction	59%	70%	73%	78%	89%
VVT - Coupled Cam Phasing (CCP) on SOHC	4%	5%	5%	7%	13%
Discrete Variable Valve Lift (DVVL) on SOHC	9%	10%	12%	13%	13%
Cylinder Deactivation on SOHC	2%	2%	2%	2%	3%
VVT - Intake Cam Phasing (ICP)	34%	29%	21%	20%	18%
VVT - Dual Cam Phasing (DCP)	45%	50%	57%	59%	61%
Discrete Variable Valve Lift (DVVL) on DOHC	17%	23%	26%	28%	34%
Continuously Variable Valve Lift (CVVL)	5%	6%	6%	6%	6%
Cylinder Deactivation on DOHC	0%	0%	0%	0%	0%
Cylinder Deactivation on OHV	1%	2%	2%	2%	2%
VVT - Coupled Cam Phasing (CCP) on OHV	4%	5%	5%	5%	6%
Discrete Variable Valve Lift (DVVL) on OHV	0%	3%	3%	4%	4%
Conversion to DOHC with DCP	0%	0%	0%	0%	0%
Stoichiometric Gasoline Direct Injection (GDI)	22%	30%	34%	37%	44%
Combustion Restart	0%	0%	2%	5%	9%
Turbocharging and Downsizing	15%	21%	22%	22%	26%
Exhaust Gas Recirculation (EGR) Boost	0%	7%	9%	10%	15%
Conversion to Diesel following TRBDS	1%	2%	2%	2%	2%
Conversion to Diesel following CBRST	0%	0%	0%	0%	1%
6-Speed Manual/Improved Internals	3%	3%	3%	3%	3%
Improved Auto. Trans. Controls/Externals	8%	14%	18%	16%	16%
Continuously Variable Transmission	11%	11%	11%	11%	11%
6/7/8-Speed Auto. Trans with Improved Internals	11%	6%	4%	3%	2%
Dual Clutch or Automated Manual Transmission	25%	37%	44%	55%	61%
Electric Power Steering	40%	57%	66%	74%	86%
Improved Accessories	35%	48%	52%	59%	71%
12V Micro-Hybrid	0%	0%	0%	0%	0%
Belt mounted Integrated Starter Generator	9%	19%	28%	30%	33%
Crank mounted Integrated Starter Generator	4%	4%	4%	4%	4%
Power Split Hybrid	4%	5%	5%	5%	5%
2-Mode Hybrid	0%	0%	0%	0%	0%
Plug-in Hybrid	0%	0%	0%	0%	0%
Mass Reduction (1.5%)	28%	40%	42%	50%	73%

Mass Reduction (3.5% to 8.5%)	0%	0%	14%	22%	32%
Low Rolling Resistance Tires	40%	61%	73%	80%	84%
Low Drag Brakes	4%	7%	8%	8%	12%
Secondary Axle Disconnect - Unibody	0%	0%	0%	0%	0%
Secondary Axle Disconnect - Ladder Frame	3%	4%	4%	4%	5%
Aero Drag Reduction	36%	52%	62%	69%	77%

3% Annual Increase

Technology	MY 2012	MY 2013	MY 2014	MY 2015	MY 2016
Low Friction Lubricants	61%	78%	80%	79%	79%
Engine Friction Reduction	57%	69%	71%	71%	72%
VVT - Coupled Cam Phasing (CCP) on SOHC	4%	5%	5%	5%	5%
Discrete Variable Valve Lift (DVVL) on SOHC	9%	10%	11%	12%	12%
Cylinder Deactivation on SOHC	2%	3%	3%	3%	3%
VVT - Intake Cam Phasing (ICP)	41%	34%	28%	25%	23%
VVT - Dual Cam Phasing (DCP)	39%	45%	50%	53%	53%
Discrete Variable Valve Lift (DVVL) on DOHC	12%	19%	21%	22%	25%
Continuously Variable Valve Lift (CVVL)	5%	6%	6%	6%	6%
Cylinder Deactivation on DOHC	0%	0%	0%	0%	0%
Cylinder Deactivation on OHV	1%	2%	2%	2%	2%
VVT - Coupled Cam Phasing (CCP) on OHV	4%	4%	4%	4%	4%
Discrete Variable Valve Lift (DVVL) on OHV	0%	0%	0%	0%	0%
Conversion to DOHC with DCP	0%	0%	0%	0%	0%
Stoichiometric Gasoline Direct Injection (GDI)	13%	15%	16%	18%	19%
Combustion Restart	0%	0%	3%	7%	8%
Turbocharging and Downsizing	9%	12%	13%	13%	14%
Exhaust Gas Recirculation (EGR) Boost	0%	2%	4%	4%	7%
Conversion to Diesel following TRBDS	0%	0%	0%	0%	0%
Conversion to Diesel following CBRST	0%	0%	0%	0%	0%
6-Speed Manual/Improved Internals	2%	2%	2%	2%	2%
Improved Auto. Trans. Controls/Externals	5%	12%	14%	12%	8%
Continuously Variable Transmission	11%	11%	11%	11%	11%
6/7/8-Speed Auto. Trans with Improved Internals	13%	9%	10%	11%	13%
Dual Clutch or Automated Manual Transmission	16%	31%	35%	39%	42%
Electric Power Steering	37%	55%	62%	64%	71%
Improved Accessories	29%	40%	43%	49%	60%
12V Micro-Hybrid	0%	0%	0%	0%	0%
Belt mounted Integrated Starter Generator	3%	9%	18%	23%	27%
Crank mounted Integrated Starter Generator	1%	1%	1%	1%	1%

Power Split Hybrid	3%	3%	3%	3%	3%
2-Mode Hybrid	0%	0%	0%	0%	0%
Plug-in Hybrid	0%	0%	0%	0%	0%
Mass Reduction (1.5%)	23%	37%	38%	42%	47%
Mass Reduction (3.5% to 8.5%)	0%	0%	8%	15%	23%
Low Rolling Resistance Tires	37%	54%	58%	64%	78%
Low Drag Brakes	4%	7%	9%	9%	10%
Secondary Axle Disconnect - Unibody	0%	0%	0%	0%	0%
Secondary Axle Disconnect - Ladder Frame	3%	5%	5%	5%	5%
Aero Drag Reduction	31%	41%	45%	54%	74%

4% Annual Increase

Technology	MY 2012	MY 2013	MY 2014	MY 2015	MY 2016
Low Friction Lubricants	61%	78%	80%	96%	97%
Engine Friction Reduction	57%	69%	79%	84%	92%
VVT - Coupled Cam Phasing (CCP) on SOHC	4%	5%	9%	11%	12%
Discrete Variable Valve Lift (DVVL) on SOHC	9%	10%	11%	13%	13%
Cylinder Deactivation on SOHC	2%	2%	2%	2%	2%
VVT - Intake Cam Phasing (ICP)	40%	33%	24%	19%	17%
VVT - Dual Cam Phasing (DCP)	40%	45%	53%	58%	60%
Discrete Variable Valve Lift (DVVL) on DOHC	12%	20%	23%	23%	30%
Continuously Variable Valve Lift (CVVL)	5%	6%	6%	6%	6%
Cylinder Deactivation on DOHC	0%	0%	0%	0%	1%
Cylinder Deactivation on OHV	1%	2%	2%	2%	2%
VVT - Coupled Cam Phasing (CCP) on OHV	4%	5%	5%	5%	6%
Discrete Variable Valve Lift (DVVL) on OHV	0%	0%	1%	2%	2%
Conversion to DOHC with DCP	0%	0%	0%	0%	0%
Stoichiometric Gasoline Direct Injection (GDI)	18%	28%	32%	36%	42%
Combustion Restart	0%	0%	4%	7%	12%
Turbocharging and Downsizing	9%	17%	19%	21%	23%
Exhaust Gas Recirculation (EGR) Boost	0%	9%	11%	14%	17%
Conversion to Diesel following TRBDS	0%	0%	0%	0%	0%
Conversion to Diesel following CBRST	0%	0%	0%	0%	0%
6-Speed Manual/Improved Internals	2%	2%	3%	3%	3%
Improved Auto. Trans. Controls/Externals	8%	15%	17%	15%	13%
Continuously Variable Transmission	11%	11%	11%	11%	11%
6/7/8-Speed Auto. Trans with Improved Internals	13%	9%	8%	5%	4%
Dual Clutch or Automated Manual Transmission	22%	36%	43%	55%	62%
Electric Power Steering	37%	56%	66%	73%	82%

Improved Accessories	31%	44%	47%	54%	62%
12V Micro-Hybrid	0%	0%	0%	0%	0%
Belt mounted Integrated Starter Generator	7%	13%	24%	28%	31%
Crank mounted Integrated Starter Generator	1%	1%	1%	1%	1%
Power Split Hybrid	3%	3%	3%	3%	3%
2-Mode Hybrid	0%	0%	0%	0%	0%
Plug-in Hybrid	0%	0%	0%	0%	0%
Mass Reduction (1.5%)	23%	37%	40%	48%	60%
Mass Reduction (3.5% to 8.5%)	0%	0%	13%	21%	32%
Low Rolling Resistance Tires	40%	56%	66%	74%	82%
Low Drag Brakes	4%	7%	9%	9%	11%
Secondary Axle Disconnect - Unibody	0%	0%	0%	0%	0%
Secondary Axle Disconnect - Ladder Frame	3%	5%	5%	5%	5%
Aero Drag Reduction	36%	46%	55%	63%	76%

5% Annual Increase

Technology	MY 2012	MY 2013	MY 2014	MY 2015	MY 2016
Low Friction Lubricants	78%	77%	94%	94%	96%
Engine Friction Reduction	59%	69%	77%	83%	90%
VVT - Coupled Cam Phasing (CCP) on SOHC	4%	5%	9%	11%	12%
Discrete Variable Valve Lift (DVVL) on SOHC	9%	10%	12%	13%	13%
Cylinder Deactivation on SOHC	2%	2%	2%	2%	2%
VVT - Intake Cam Phasing (ICP)	37%	28%	20%	17%	15%
VVT - Dual Cam Phasing (DCP)	42%	47%	54%	58%	59%
Discrete Variable Valve Lift (DVVL) on DOHC	17%	26%	33%	35%	42%
Continuously Variable Valve Lift (CVVL)	5%	6%	6%	6%	6%
Cylinder Deactivation on DOHC	0%	0%	0%	0%	0%
Cylinder Deactivation on OHV	1%	2%	2%	2%	2%
VVT - Coupled Cam Phasing (CCP) on OHV	4%	5%	5%	5%	6%
Discrete Variable Valve Lift (DVVL) on OHV	0%	3%	3%	4%	4%
Conversion to DOHC with DCP	0%	0%	0%	0%	0%
Stoichiometric Gasoline Direct Injection (GDI)	22%	35%	44%	49%	55%
Combustion Restart	0%	0%	2%	6%	13%
Turbocharging and Downsizing	13%	24%	31%	34%	40%
Exhaust Gas Recirculation (EGR) Boost	0%	13%	20%	24%	34%
Conversion to Diesel following TRBDS	1%	3%	3%	3%	3%
Conversion to Diesel following CBRST	0%	0%	1%	1%	1%
6-Speed Manual/Improved Internals	3%	3%	4%	4%	4%
Improved Auto. Trans. Controls/Externals	8%	15%	17%	12%	2%
Continuously Variable Transmission	11%	11%	11%	11%	11%
6/7/8-Speed Auto. Trans with Improved Internals	11%	6%	4%	2%	0%
Dual Clutch or Automated Manual Transmission	26%	45%	55%	66%	78%
Electric Power Steering	40%	59%	71%	78%	95%
Improved Accessories	31%	44%	51%	59%	81%
12V Micro-Hybrid	0%	0%	0%	0%	0%
Belt mounted Integrated Starter Generator	12%	22%	35%	39%	42%
Crank mounted Integrated Starter Generator	1%	2%	2%	3%	3%
Power Split Hybrid	3%	4%	4%	4%	4%
2-Mode Hybrid	0%	0%	0%	0%	0%
Plug-in Hybrid	0%	0%	0%	0%	0%
Mass Reduction (1.5%)	23%	38%	47%	55%	82%
Mass Reduction (3.5% to 8.5%)	0%	0%	15%	23%	34%
Low Rolling Resistance Tires	40%	58%	70%	77%	92%
Low Drag Brakes	4%	8%	9%	10%	12%

Secondary Axle Disconnect - Unibody	0%	0%	0%	0%	0%
Secondary Axle Disconnect - Ladder Frame	3%	5%	5%	5%	6%
Aero Drag Reduction	36%	53%	63%	69%	82%

6% Annual Increase

Technology	MY 2012	MY 2013	MY 2014	MY 2015	MY 2016
Low Friction Lubricants	80%	78%	95%	95%	94%
Engine Friction Reduction	59%	74%	84%	88%	93%
VVT - Coupled Cam Phasing (CCP) on SOHC	4%	5%	9%	11%	12%
Discrete Variable Valve Lift (DVVL) on SOHC	9%	10%	12%	13%	13%
Cylinder Deactivation on SOHC	2%	1%	1%	0%	0%
VVT - Intake Cam Phasing (ICP)	34%	25%	17%	12%	0%
VVT - Dual Cam Phasing (DCP)	44%	49%	56%	60%	72%
Discrete Variable Valve Lift (DVVL) on DOHC	24%	33%	43%	46%	53%
Continuously Variable Valve Lift (CVVL)	5%	6%	6%	6%	6%
Cylinder Deactivation on DOHC	0%	1%	1%	1%	0%
Cylinder Deactivation on OHV	1%	2%	2%	1%	1%
VVT - Coupled Cam Phasing (CCP) on OHV	4%	5%	6%	6%	6%
Discrete Variable Valve Lift (DVVL) on OHV	0%	3%	4%	5%	6%
Conversion to DOHC with DCP	0%	0%	0%	0%	0%
Stoichiometric Gasoline Direct Injection (GDI)	23%	37%	49%	54%	66%
Combustion Restart	0%	0%	2%	6%	20%
Turbocharging and Downsizing	16%	28%	39%	44%	50%
Exhaust Gas Recirculation (EGR) Boost	0%	13%	25%	31%	42%
Conversion to Diesel following TRBDS	1%	3%	4%	4%	4%
Conversion to Diesel following CBRST	0%	0%	1%	1%	1%
6-Speed Manual/Improved Internals	3%	3%	4%	4%	4%
Improved Auto. Trans. Controls/Externals	8%	15%	16%	11%	1%
Continuously Variable Transmission	11%	11%	9%	9%	9%
6/7/8-Speed Auto. Trans with Improved Internals	11%	6%	4%	2%	0%
Dual Clutch or Automated Manual Transmission	26%	42%	54%	65%	76%
Electric Power Steering	40%	65%	76%	83%	92%
Improved Accessories	35%	50%	58%	69%	84%
12V Micro-Hybrid	0%	0%	0%	0%	0%
Belt mounted Integrated Starter Generator	13%	22%	31%	39%	45%
Crank mounted Integrated Starter Generator	4%	5%	6%	7%	7%
Power Split Hybrid	4%	6%	8%	9%	9%
2-Mode Hybrid	0%	0%	0%	0%	0%

Plug-in Hybrid	0%	0%	0%	0%	0%
Mass Reduction (1.5%)	27%	43%	56%	64%	84%
Mass Reduction (3.5% to 8.5%)	0%	0%	18%	27%	41%
Low Rolling Resistance Tires	40%	63%	74%	80%	92%
Low Drag Brakes	4%	8%	10%	10%	12%
Secondary Axle Disconnect - Unibody	0%	0%	0%	0%	0%
Secondary Axle Disconnect - Ladder Frame	3%	5%	5%	5%	6%
Aero Drag Reduction	36%	53%	63%	69%	82%

7% Annual Increase

Technology	MY 2012	MY 2013	MY 2014	MY 2015	MY 2016
Low Friction Lubricants	80%	79%	95%	94%	94%
Engine Friction Reduction	59%	77%	87%	88%	92%
VVT - Coupled Cam Phasing (CCP) on SOHC	4%	8%	13%	12%	12%
Discrete Variable Valve Lift (DVVL) on SOHC	9%	10%	12%	13%	13%
Cylinder Deactivation on SOHC	2%	1%	1%	0%	0%
VVT - Intake Cam Phasing (ICP)	34%	25%	17%	12%	0%
VVT - Dual Cam Phasing (DCP)	44%	49%	56%	60%	72%
Discrete Variable Valve Lift (DVVL) on DOHC	26%	35%	45%	51%	62%
Continuously Variable Valve Lift (CVVL)	5%	6%	7%	6%	6%
Cylinder Deactivation on DOHC	0%	1%	1%	1%	0%
Cylinder Deactivation on OHV	1%	2%	2%	1%	0%
VVT - Coupled Cam Phasing (CCP) on OHV	4%	5%	6%	5%	5%
Discrete Variable Valve Lift (DVVL) on OHV	0%	3%	4%	5%	5%
Conversion to DOHC with DCP	0%	0%	0%	0%	0%
Stoichiometric Gasoline Direct Injection (GDI)	31%	47%	63%	71%	86%
Combustion Restart	0%	0%	3%	9%	28%
Turbocharging and Downsizing	17%	31%	45%	53%	65%
Exhaust Gas Recirculation (EGR) Boost	0%	16%	31%	40%	59%
Conversion to Diesel following TRBDS	1%	3%	4%	4%	4%
Conversion to Diesel following CBRST	0%	0%	1%	2%	2%
6-Speed Manual/Improved Internals	3%	3%	4%	4%	5%
Improved Auto. Trans. Controls/Externals	8%	15%	16%	11%	1%
Continuously Variable Transmission	11%	11%	10%	10%	10%
6/7/8-Speed Auto. Trans with Improved Internals	11%	6%	4%	2%	0%
Dual Clutch or Automated Manual Transmission	26%	43%	54%	65%	76%
Electric Power Steering	40%	67%	83%	89%	92%
Improved Accessories	35%	59%	70%	78%	89%

12V Micro-Hybrid	0%	0%	0%	0%	0%
Belt mounted Integrated Starter Generator	15%	24%	37%	45%	50%
Crank mounted Integrated Starter Generator	4%	5%	5%	6%	6%
Power Split Hybrid	4%	7%	8%	8%	9%
2-Mode Hybrid	0%	0%	0%	0%	0%
Plug-in Hybrid	0%	0%	0%	0%	0%
Mass Reduction (1.5%)	27%	50%	68%	77%	95%
Mass Reduction (3.5% to 8.5%)	0%	0%	19%	31%	52%
Low Rolling Resistance Tires	40%	63%	75%	80%	92%
Low Drag Brakes	4%	8%	10%	10%	12%
Secondary Axle Disconnect - Unibody	0%	0%	0%	0%	0%
Secondary Axle Disconnect - Ladder Frame	3%	5%	5%	5%	6%
Aero Drag Reduction	36%	56%	66%	71%	82%

Max Net Benefit

Technology	MY 2012	MY 2013	MY 2014	MY 2015	MY 2016
Low Friction Lubricants	80%	94%	95%	94%	94%
Engine Friction Reduction	59%	77%	87%	89%	92%
VVT - Coupled Cam Phasing (CCP) on SOHC	4%	8%	13%	12%	12%
Discrete Variable Valve Lift (DVVL) on SOHC	9%	10%	12%	13%	13%
Cylinder Deactivation on SOHC	2%	1%	1%	1%	1%
VVT - Intake Cam Phasing (ICP)	34%	25%	16%	12%	11%
VVT - Dual Cam Phasing (DCP)	45%	49%	56%	61%	61%
Discrete Variable Valve Lift (DVVL) on DOHC	25%	34%	42%	45%	52%
Continuously Variable Valve Lift (CVVL)	5%	6%	6%	6%	6%
Cylinder Deactivation on DOHC	0%	2%	1%	1%	0%
Cylinder Deactivation on OHV	1%	2%	2%	1%	1%
VVT - Coupled Cam Phasing (CCP) on OHV	4%	5%	6%	5%	5%
Discrete Variable Valve Lift (DVVL) on OHV	0%	3%	4%	5%	5%
Conversion to DOHC with DCP	0%	0%	0%	0%	0%
Stoichiometric Gasoline Direct Injection (GDI)	26%	40%	52%	58%	68%
Combustion Restart	0%	0%	2%	5%	14%
Turbocharging and Downsizing	16%	28%	39%	43%	47%
Exhaust Gas Recirculation (EGR) Boost	0%	13%	25%	31%	39%
Conversion to Diesel following TRBDS	1%	3%	4%	4%	4%
Conversion to Diesel following CBRST	0%	0%	1%	1%	2%
6-Speed Manual/Improved Internals	3%	3%	4%	4%	4%
Improved Auto. Trans. Controls/Externals	8%	14%	16%	11%	1%
Continuously Variable Transmission	11%	11%	10%	10%	10%
6/7/8-Speed Auto. Trans with Improved	11%	6%	4%	2%	1%

Internals					
Dual Clutch or Automated Manual Transmission	26%	44%	55%	65%	75%
Electric Power Steering	40%	67%	83%	89%	89%
Improved Accessories	35%	61%	70%	78%	84%
12V Micro-Hybrid	0%	0%	0%	0%	0%
Belt mounted Integrated Starter Generator	15%	24%	37%	46%	50%
Crank mounted Integrated Starter Generator	4%	5%	5%	6%	6%
Power Split Hybrid	4%	6%	7%	8%	9%
2-Mode Hybrid	0%	0%	0%	0%	0%
Plug-in Hybrid	0%	0%	0%	0%	0%
Mass Reduction (1.5%)	27%	52%	69%	76%	80%
Mass Reduction (3.5% to 8.5%)	0%	0%	19%	28%	47%
Low Rolling Resistance Tires	40%	63%	75%	80%	92%
Low Drag Brakes	4%	10%	11%	12%	12%
Secondary Axle Disconnect - Unibody	0%	0%	0%	0%	0%
Secondary Axle Disconnect - Ladder Frame	3%	5%	6%	6%	6%
Aero Drag Reduction	36%	56%	66%	71%	82%

Total Cost = Total Benefit

Technology	MY 2012	MY 2013	MY 2014	MY 2015	MY 2016
Low Friction Lubricants	80%	94%	95%	94%	94%
Engine Friction Reduction	59%	77%	87%	89%	92%
VVT - Coupled Cam Phasing (CCP) on SOHC	4%	8%	13%	12%	13%
Discrete Variable Valve Lift (DVVL) on SOHC	9%	10%	12%	13%	13%
Cylinder Deactivation on SOHC	2%	1%	1%	0%	0%
VVT - Intake Cam Phasing (ICP)	34%	23%	15%	11%	0%
VVT - Dual Cam Phasing (DCP)	45%	51%	58%	61%	72%
Discrete Variable Valve Lift (DVVL) on DOHC	28%	37%	49%	51%	59%
Continuously Variable Valve Lift (CVVL)	5%	6%	6%	6%	6%
Cylinder Deactivation on DOHC	0%	2%	2%	2%	0%
Cylinder Deactivation on OHV	1%	2%	2%	1%	0%
VVT - Coupled Cam Phasing (CCP) on OHV	4%	5%	6%	5%	5%
Discrete Variable Valve Lift (DVVL) on OHV	0%	3%	4%	5%	5%
Conversion to DOHC with DCP	0%	0%	0%	0%	0%
Stoichiometric Gasoline Direct Injection (GDI)	33%	49%	65%	70%	82%
Combustion Restart	0%	0%	2%	9%	20%
Turbocharging and Downsizing	17%	30%	45%	50%	62%
Exhaust Gas Recirculation (EGR) Boost	0%	15%	31%	38%	55%
Conversion to Diesel following TRBDS	1%	3%	4%	4%	4%

Conversion to Diesel following CBRST	0%	0%	1%	2%	2%
6-Speed Manual/Improved Internals	3%	3%	4%	4%	5%
Improved Auto. Trans. Controls/Externals	8%	15%	16%	11%	0%
Continuously Variable Transmission	11%	11%	10%	10%	10%
6/7/8-Speed Auto. Trans with Improved Internals	11%	6%	4%	2%	0%
Dual Clutch or Automated Manual Transmission	27%	44%	55%	65%	77%
Electric Power Steering	42%	68%	84%	90%	90%
Improved Accessories	35%	61%	70%	79%	84%
12V Micro-Hybrid	0%	0%	0%	0%	0%
Belt mounted Integrated Starter Generator	18%	31%	44%	53%	58%
Crank mounted Integrated Starter Generator	4%	5%	5%	6%	6%
Power Split Hybrid	4%	6%	7%	8%	9%
2-Mode Hybrid	0%	0%	0%	0%	0%
Plug-in Hybrid	0%	0%	0%	0%	0%
Mass Reduction (1.5%)	30%	51%	67%	75%	90%
Mass Reduction (3.5% to 8.5%)	0%	0%	19%	31%	50%
Low Rolling Resistance Tires	42%	66%	76%	80%	92%
Low Drag Brakes	4%	10%	11%	12%	12%
Secondary Axle Disconnect - Unibody	0%	0%	0%	0%	0%
Secondary Axle Disconnect - Ladder Frame	3%	5%	6%	6%	6%
Aero Drag Reduction	38%	57%	67%	71%	82%

Table V-46
Penetration Rate of New Technologies to Light Trucks
By Alternative

Preferred Alternative

Technology	MY 2012	MY 2013	MY 2014	MY 2015	MY 2016
Low Friction Lubricants	96%	97%	96%	97%	97%
Engine Friction Reduction	72%	77%	86%	94%	94%
VVT - Coupled Cam Phasing (CCP) on SOHC	12%	12%	19%	21%	21%
Discrete Variable Valve Lift (DVVL) on SOHC	11%	11%	12%	21%	22%
Cylinder Deactivation on SOHC	10%	10%	11%	14%	17%
VVT - Intake Cam Phasing (ICP)	8%	5%	4%	4%	1%
VVT - Dual Cam Phasing (DCP)	42%	45%	48%	50%	52%
Discrete Variable Valve Lift (DVVL) on DOHC	20%	24%	28%	29%	33%
Continuously Variable Valve Lift (CVVL)	4%	4%	4%	4%	4%
Cylinder Deactivation on DOHC	1%	1%	2%	5%	4%
Cylinder Deactivation on OHV	11%	16%	17%	17%	21%

VVT - Coupled Cam Phasing (CCP) on OHV	4%	5%	6%	7%	21%
Discrete Variable Valve Lift (DVVL) on OHV	0%	14%	17%	19%	19%
Conversion to DOHC with DCP	0%	0%	0%	0%	0%
Stoichiometric Gasoline Direct Injection (GDI)	27%	43%	50%	52%	56%
Combustion Restart	0%	0%	2%	8%	14%
Turbocharging and Downsizing	11%	13%	14%	14%	15%
Exhaust Gas Recirculation (EGR) Boost	0%	3%	3%	4%	7%
Conversion to Diesel following TRBDS	1%	1%	1%	1%	1%
Conversion to Diesel following CBRST	1%	1%	1%	1%	1%
6-Speed Manual/Improved Internals	1%	1%	1%	1%	1%
Improved Auto. Trans. Controls/Externals	35%	29%	26%	10%	0%
Continuously Variable Transmission	4%	4%	4%	4%	4%
6/7/8-Speed Auto. Trans with Improved Internals	8%	3%	0%	0%	1%
Dual Clutch or Automated Manual Transmission	30%	51%	67%	83%	92%
Electric Power Steering	52%	77%	86%	91%	96%
Improved Accessories	28%	35%	42%	47%	53%
12V Micro-Hybrid	0%	0%	0%	0%	0%
Belt mounted Integrated Starter Generator	12%	15%	23%	25%	27%
Crank mounted Integrated Starter Generator	0%	0%	0%	0%	0%
Power Split Hybrid	2%	2%	2%	2%	2%
2-Mode Hybrid	0%	0%	0%	0%	0%
Plug-in Hybrid	0%	0%	0%	0%	0%
Mass Reduction (1.5%)	32%	35%	39%	49%	71%
Mass Reduction (3.5% to 8.5%)	0%	0%	10%	23%	31%
Low Rolling Resistance Tires	84%	91%	95%	95%	95%
Low Drag Brakes	28%	32%	40%	48%	68%
Secondary Axle Disconnect - Unibody	0%	0%	0%	0%	0%
Secondary Axle Disconnect - Ladder Frame	22%	23%	27%	32%	33%
Aero Drag Reduction	86%	90%	95%	97%	100%

3% Annual Increase

Technology	MY 2012	MY 2013	MY 2014	MY 2015	MY 2016
Low Friction Lubricants	77%	78%	81%	97%	97%
Engine Friction Reduction	71%	74%	82%	93%	93%
VVT - Coupled Cam Phasing (CCP) on SOHC	12%	12%	19%	19%	19%
Discrete Variable Valve Lift (DVVL) on SOHC	10%	10%	11%	17%	17%
Cylinder Deactivation on SOHC	9%	9%	16%	17%	17%
VVT - Intake Cam Phasing (ICP)	11%	9%	8%	8%	4%
VVT - Dual Cam Phasing (DCP)	41%	42%	45%	46%	50%

Discrete Variable Valve Lift (DVVL) on DOHC	12%	14%	16%	16%	16%
Continuously Variable Valve Lift (CVVL)	4%	4%	4%	4%	4%
Cylinder Deactivation on DOHC	2%	3%	4%	4%	4%
Cylinder Deactivation on OHV	10%	10%	10%	10%	18%
VVT - Coupled Cam Phasing (CCP) on OHV	4%	4%	4%	4%	4%
Discrete Variable Valve Lift (DVVL) on OHV	0%	9%	12%	13%	13%
Conversion to DOHC with DCP	0%	0%	0%	0%	0%
Stoichiometric Gasoline Direct Injection (GDI)	17%	17%	21%	21%	24%
Combustion Restart	0%	0%	1%	4%	4%
Turbocharging and Downsizing	7%	7%	7%	7%	8%
Exhaust Gas Recirculation (EGR) Boost	0%	1%	1%	1%	3%
Conversion to Diesel following TRBDS	1%	1%	1%	1%	1%
Conversion to Diesel following CBRST	0%	0%	0%	0%	0%
6-Speed Manual/Improved Internals	1%	1%	1%	1%	1%
Improved Auto. Trans. Controls/Externals	32%	22%	24%	13%	12%
Continuously Variable Transmission	4%	4%	4%	4%	4%
6/7/8-Speed Auto. Trans with Improved Internals	12%	9%	12%	13%	18%
Dual Clutch or Automated Manual Transmission	20%	39%	46%	59%	60%
Electric Power Steering	45%	55%	66%	72%	91%
Improved Accessories	22%	24%	26%	31%	42%
12V Micro-Hybrid	0%	0%	0%	0%	0%
Belt mounted Integrated Starter Generator	11%	14%	19%	19%	21%
Crank mounted Integrated Starter Generator	0%	0%	0%	0%	0%
Power Split Hybrid	2%	2%	2%	2%	2%
2-Mode Hybrid	0%	0%	0%	0%	0%
Plug-in Hybrid	0%	0%	0%	0%	0%
Mass Reduction (1.5%)	18%	19%	23%	33%	39%
Mass Reduction (3.5% to 8.5%)	0%	0%	4%	12%	14%
Low Rolling Resistance Tires	69%	76%	87%	96%	97%
Low Drag Brakes	16%	17%	19%	25%	34%
Secondary Axle Disconnect - Unibody	0%	0%	0%	0%	0%
Secondary Axle Disconnect - Ladder Frame	12%	14%	19%	21%	21%
Aero Drag Reduction	76%	80%	89%	97%	100%

4% Annual Increase

Technology	MY 2012	MY 2013	MY 2014	MY 2015	MY 2016
Low Friction Lubricants	77%	91%	96%	97%	97%
Engine Friction Reduction	71%	74%	82%	94%	94%
VVT - Coupled Cam Phasing (CCP) on SOHC	12%	12%	18%	20%	20%

Discrete Variable Valve Lift (DVVL) on SOHC	11%	11%	11%	17%	17%
Cylinder Deactivation on SOHC	9%	10%	16%	19%	19%
VVT - Intake Cam Phasing (ICP)	11%	8%	7%	7%	4%
VVT - Dual Cam Phasing (DCP)	41%	42%	45%	46%	50%
Discrete Variable Valve Lift (DVVL) on DOHC	20%	24%	29%	29%	34%
Continuously Variable Valve Lift (CVVL)	4%	4%	4%	4%	4%
Cylinder Deactivation on DOHC	1%	3%	3%	6%	5%
Cylinder Deactivation on OHV	10%	11%	12%	11%	20%
VVT - Coupled Cam Phasing (CCP) on OHV	4%	4%	5%	5%	19%
Discrete Variable Valve Lift (DVVL) on OHV	0%	14%	17%	19%	19%
Conversion to DOHC with DCP	0%	0%	0%	0%	0%
Stoichiometric Gasoline Direct Injection (GDI)	28%	41%	46%	47%	52%
Combustion Restart	0%	0%	1%	7%	12%
Turbocharging and Downsizing	13%	15%	16%	16%	18%
Exhaust Gas Recirculation (EGR) Boost	0%	3%	3%	4%	7%
Conversion to Diesel following TRBDS	1%	1%	2%	2%	2%
Conversion to Diesel following CBRST	0%	0%	0%	0%	0%
6-Speed Manual/Improved Internals	1%	1%	1%	1%	1%
Improved Auto. Trans. Controls/Externals	32%	25%	24%	10%	0%
Continuously Variable Transmission	4%	4%	4%	4%	4%
6/7/8-Speed Auto. Trans with Improved Internals	8%	3%	0%	0%	1%
Dual Clutch or Automated Manual Transmission	29%	50%	67%	83%	92%
Electric Power Steering	45%	69%	78%	85%	91%
Improved Accessories	22%	30%	40%	42%	47%
12V Micro-Hybrid	0%	0%	0%	0%	0%
Belt mounted Integrated Starter Generator	14%	19%	24%	26%	27%
Crank mounted Integrated Starter Generator	0%	0%	0%	0%	0%
Power Split Hybrid	2%	2%	2%	2%	2%
2-Mode Hybrid	0%	0%	0%	0%	0%
Plug-in Hybrid	0%	0%	0%	0%	0%
Mass Reduction (1.5%)	18%	20%	29%	39%	44%
Mass Reduction (3.5% to 8.5%)	0%	0%	10%	22%	27%
Low Rolling Resistance Tires	69%	76%	87%	96%	97%
Low Drag Brakes	16%	20%	25%	34%	46%
Secondary Axle Disconnect - Unibody	0%	0%	0%	0%	0%
Secondary Axle Disconnect - Ladder Frame	12%	14%	20%	24%	25%
Aero Drag Reduction	76%	81%	90%	97%	100%

5% Annual Increase

Technology	MY 2012	MY 2013	MY 2014	MY 2015	MY 2016
Low Friction Lubricants	74%	93%	91%	91%	90%
Engine Friction Reduction	69%	71%	80%	89%	88%
VVT - Coupled Cam Phasing (CCP) on SOHC	12%	12%	18%	19%	19%
Discrete Variable Valve Lift (DVVL) on SOHC	10%	11%	10%	20%	20%
Cylinder Deactivation on SOHC	9%	10%	13%	14%	10%
VVT - Intake Cam Phasing (ICP)	11%	7%	1%	1%	0%
VVT - Dual Cam Phasing (DCP)	38%	39%	47%	49%	49%
Discrete Variable Valve Lift (DVVL) on DOHC	17%	20%	26%	27%	28%
Continuously Variable Valve Lift (CVVL)	4%	4%	4%	4%	4%
Cylinder Deactivation on DOHC	1%	3%	3%	3%	2%
Cylinder Deactivation on OHV	10%	11%	12%	9%	13%
VVT - Coupled Cam Phasing (CCP) on OHV	4%	5%	6%	4%	18%
Discrete Variable Valve Lift (DVVL) on OHV	0%	14%	17%	20%	20%
Conversion to DOHC with DCP	0%	0%	0%	0%	0%
Stoichiometric Gasoline Direct Injection (GDI)	26%	43%	54%	63%	66%
Combustion Restart	0%	0%	1%	6%	30%
Turbocharging and Downsizing	17%	24%	33%	35%	40%
Exhaust Gas Recirculation (EGR) Boost	0%	8%	17%	19%	26%
Conversion to Diesel following TRBDS	3%	5%	7%	8%	8%
Conversion to Diesel following CBRST	1%	1%	1%	1%	1%
6-Speed Manual/Improved Internals	1%	1%	1%	1%	1%
Improved Auto. Trans. Controls/Externals	32%	25%	30%	17%	7%
Continuously Variable Transmission	3%	3%	3%	3%	3%
6/7/8-Speed Auto. Trans with Improved Internals	11%	6%	4%	5%	9%
Dual Clutch or Automated Manual Transmission	27%	46%	57%	70%	76%
Electric Power Steering	45%	70%	85%	88%	90%
Improved Accessories	22%	31%	43%	44%	47%
12V Micro-Hybrid	0%	0%	0%	0%	0%
Belt mounted Integrated Starter Generator	19%	22%	33%	36%	43%
Crank mounted Integrated Starter Generator	1%	1%	1%	1%	1%
Power Split Hybrid	2%	4%	4%	4%	4%
2-Mode Hybrid	0%	0%	0%	0%	0%
Plug-in Hybrid	0%	0%	0%	0%	0%
Mass Reduction (1.5%)	18%	26%	41%	65%	74%
Mass Reduction (3.5% to 8.5%)	0%	0%	18%	35%	47%
Low Rolling Resistance Tires	69%	76%	88%	98%	98%
Low Drag Brakes	17%	26%	35%	57%	76%

Secondary Axle Disconnect - Unibody	0%	0%	0%	0%	0%
Secondary Axle Disconnect - Ladder Frame	13%	17%	23%	44%	45%
Aero Drag Reduction	77%	81%	90%	97%	100%

6% Annual Increase

Technology	MY 2012	MY 2013	MY 2014	MY 2015	MY 2016
Low Friction Lubricants	74%	92%	89%	82%	81%
Engine Friction Reduction	69%	71%	78%	80%	79%
VVT - Coupled Cam Phasing (CCP) on SOHC	12%	12%	16%	12%	11%
Discrete Variable Valve Lift (DVVL) on SOHC	10%	10%	9%	12%	12%
Cylinder Deactivation on SOHC	9%	10%	13%	8%	4%
VVT - Intake Cam Phasing (ICP)	11%	6%	1%	0%	0%
VVT - Dual Cam Phasing (DCP)	38%	40%	48%	49%	49%
Discrete Variable Valve Lift (DVVL) on DOHC	17%	21%	28%	31%	33%
Continuously Variable Valve Lift (CVVL)	4%	4%	4%	4%	4%
Cylinder Deactivation on DOHC	1%	3%	4%	4%	3%
Cylinder Deactivation on OHV	10%	5%	3%	2%	2%
VVT - Coupled Cam Phasing (CCP) on OHV	4%	6%	7%	6%	20%
Discrete Variable Valve Lift (DVVL) on OHV	0%	14%	17%	19%	20%
Conversion to DOHC with DCP	0%	0%	0%	0%	0%
Stoichiometric Gasoline Direct Injection (GDI)	26%	44%	55%	61%	66%
Combustion Restart	0%	0%	4%	10%	33%
Turbocharging and Downsizing	21%	39%	50%	53%	55%
Exhaust Gas Recirculation (EGR) Boost	0%	18%	30%	34%	45%
Conversion to Diesel following TRBDS	3%	5%	8%	15%	17%
Conversion to Diesel following CBRST	2%	2%	2%	2%	2%
6-Speed Manual/Improved Internals	1%	1%	1%	1%	2%
Improved Auto. Trans. Controls/Externals	32%	25%	25%	10%	0%
Continuously Variable Transmission	3%	3%	1%	1%	1%
6/7/8-Speed Auto. Trans with Improved Internals	8%	3%	0%	0%	0%
Dual Clutch or Automated Manual Transmission	29%	49%	65%	81%	91%
Electric Power Steering	46%	71%	86%	89%	91%
Improved Accessories	22%	31%	45%	47%	47%
12V Micro-Hybrid	0%	0%	0%	0%	0%
Belt mounted Integrated Starter Generator	18%	21%	32%	35%	41%
Crank mounted Integrated Starter Generator	2%	2%	3%	3%	3%
Power Split Hybrid	3%	4%	6%	6%	6%
2-Mode Hybrid	0%	0%	0%	0%	0%
Plug-in Hybrid	0%	0%	0%	0%	0%

Mass Reduction (1.5%)	18%	30%	47%	70%	92%
Mass Reduction (3.5% to 8.5%)	0%	0%	19%	36%	52%
Low Rolling Resistance Tires	71%	79%	88%	96%	96%
Low Drag Brakes	17%	28%	41%	62%	83%
Secondary Axle Disconnect - Unibody	0%	0%	0%	0%	0%
Secondary Axle Disconnect - Ladder Frame	14%	18%	24%	44%	52%
Aero Drag Reduction	85%	89%	95%	97%	100%

7% Annual Increase

Technology	MY 2012	MY 2013	MY 2014	MY 2015	MY 2016
Low Friction Lubricants	80%	91%	89%	80%	79%
Engine Friction Reduction	69%	70%	79%	80%	78%
VVT - Coupled Cam Phasing (CCP) on SOHC	12%	12%	17%	13%	12%
Discrete Variable Valve Lift (DVVL) on SOHC	10%	10%	9%	12%	12%
Cylinder Deactivation on SOHC	9%	10%	14%	4%	1%
VVT - Intake Cam Phasing (ICP)	9%	5%	0%	0%	0%
VVT - Dual Cam Phasing (DCP)	39%	40%	47%	47%	47%
Discrete Variable Valve Lift (DVVL) on DOHC	18%	22%	32%	34%	39%
Continuously Variable Valve Lift (CVVL)	4%	4%	4%	4%	4%
Cylinder Deactivation on DOHC	1%	3%	4%	4%	2%
Cylinder Deactivation on OHV	10%	5%	3%	1%	0%
VVT - Coupled Cam Phasing (CCP) on OHV	4%	18%	20%	20%	20%
Discrete Variable Valve Lift (DVVL) on OHV	0%	14%	16%	19%	20%
Conversion to DOHC with DCP	0%	0%	0%	0%	0%
Stoichiometric Gasoline Direct Injection (GDI)	27%	44%	59%	64%	72%
Combustion Restart	0%	0%	4%	15%	31%
Turbocharging and Downsizing	20%	38%	52%	58%	67%
Exhaust Gas Recirculation (EGR) Boost	0%	18%	34%	42%	58%
Conversion to Diesel following TRBDS	4%	6%	9%	16%	17%
Conversion to Diesel following CBRST	1%	2%	2%	3%	4%
6-Speed Manual/Improved Internals	1%	1%	1%	1%	2%
Improved Auto. Trans. Controls/Externals	35%	29%	26%	10%	0%
Continuously Variable Transmission	3%	3%	1%	1%	1%
6/7/8-Speed Auto. Trans with Improved Internals	9%	3%	0%	0%	0%
Dual Clutch or Automated Manual Transmission	29%	48%	62%	78%	88%
Electric Power Steering	49%	73%	88%	89%	91%
Improved Accessories	22%	31%	46%	47%	48%
12V Micro-Hybrid	0%	0%	0%	0%	0%
Belt mounted Integrated Starter Generator	17%	19%	27%	30%	39%

Crank mounted Integrated Starter Generator	4%	4%	6%	7%	8%
Power Split Hybrid	3%	5%	9%	9%	10%
2-Mode Hybrid	0%	0%	0%	0%	0%
Plug-in Hybrid	0%	0%	0%	0%	0%
Mass Reduction (1.5%)	25%	39%	63%	76%	92%
Mass Reduction (3.5% to 8.5%)	0%	0%	20%	37%	54%
Low Rolling Resistance Tires	83%	90%	95%	95%	95%
Low Drag Brakes	26%	52%	69%	78%	81%
Secondary Axle Disconnect - Unibody	0%	0%	0%	0%	0%
Secondary Axle Disconnect - Ladder Frame	19%	23%	38%	51%	59%
Aero Drag Reduction	86%	90%	95%	97%	100%

Max Net Benefit

Technology	MY 2012	MY 2013	MY 2014	MY 2015	MY 2016
Low Friction Lubricants	96%	92%	88%	86%	85%
Engine Friction Reduction	83%	84%	87%	85%	84%
VVT - Coupled Cam Phasing (CCP) on SOHC	16%	17%	18%	18%	18%
Discrete Variable Valve Lift (DVVL) on SOHC	10%	11%	9%	18%	18%
Cylinder Deactivation on SOHC	11%	12%	14%	8%	8%
VVT - Intake Cam Phasing (ICP)	8%	4%	1%	1%	1%
VVT - Dual Cam Phasing (DCP)	45%	44%	47%	46%	45%
Discrete Variable Valve Lift (DVVL) on DOHC	20%	22%	27%	28%	33%
Continuously Variable Valve Lift (CVVL)	4%	4%	5%	5%	5%
Cylinder Deactivation on DOHC	2%	8%	9%	7%	6%
Cylinder Deactivation on OHV	11%	6%	5%	2%	2%
VVT - Coupled Cam Phasing (CCP) on OHV	6%	20%	22%	21%	20%
Discrete Variable Valve Lift (DVVL) on OHV	0%	14%	17%	20%	20%
Conversion to DOHC with DCP	0%	0%	0%	0%	0%
Stoichiometric Gasoline Direct Injection (GDI)	29%	45%	54%	65%	66%
Combustion Restart	0%	0%	4%	19%	29%
Turbocharging and Downsizing	24%	41%	49%	57%	58%
Exhaust Gas Recirculation (EGR) Boost	0%	18%	27%	35%	42%
Conversion to Diesel following TRBDS	3%	7%	10%	11%	11%
Conversion to Diesel following CBRST	1%	2%	2%	3%	4%
6-Speed Manual/Improved Internals	1%	1%	1%	1%	1%
Improved Auto. Trans. Controls/Externals	35%	29%	26%	12%	6%
Continuously Variable Transmission	3%	3%	1%	1%	1%
6/7/8-Speed Auto. Trans with Improved Internals	8%	3%	0%	0%	0%
Dual Clutch or Automated Manual Transmission	28%	47%	63%	77%	83%

Electric Power Steering	60%	85%	96%	97%	98%
Improved Accessories	38%	48%	59%	59%	59%
12V Micro-Hybrid	0%	0%	0%	0%	0%
Belt mounted Integrated Starter Generator	14%	17%	28%	30%	32%
Crank mounted Integrated Starter Generator	3%	3%	4%	5%	5%
Power Split Hybrid	4%	5%	7%	7%	7%
2-Mode Hybrid	0%	1%	1%	1%	1%
Plug-in Hybrid	0%	0%	0%	0%	0%
Mass Reduction (1.5%)	40%	67%	82%	88%	90%
Mass Reduction (3.5% to 8.5%)	0%	0%	19%	36%	48%
Low Rolling Resistance Tires	85%	92%	95%	95%	95%
Low Drag Brakes	35%	63%	75%	78%	80%
Secondary Axle Disconnect - Unibody	0%	0%	0%	0%	0%
Secondary Axle Disconnect - Ladder Frame	30%	41%	46%	56%	58%
Aero Drag Reduction	86%	91%	95%	97%	100%

Total Cost = Total Benefit

Technology	MY 2012	MY 2013	MY 2014	MY 2015	MY 2016
Low Friction Lubricants	96%	91%	88%	79%	78%
Engine Friction Reduction	83%	83%	87%	78%	77%
VVT - Coupled Cam Phasing (CCP) on SOHC	16%	17%	18%	12%	12%
Discrete Variable Valve Lift (DVVL) on SOHC	10%	11%	9%	12%	12%
Cylinder Deactivation on SOHC	11%	12%	14%	8%	4%
VVT - Intake Cam Phasing (ICP)	8%	4%	1%	0%	0%
VVT - Dual Cam Phasing (DCP)	45%	44%	47%	46%	45%
Discrete Variable Valve Lift (DVVL) on DOHC	20%	22%	29%	30%	31%
Continuously Variable Valve Lift (CVVL)	4%	4%	5%	5%	5%
Cylinder Deactivation on DOHC	2%	8%	9%	7%	5%
Cylinder Deactivation on OHV	11%	6%	5%	2%	2%
VVT - Coupled Cam Phasing (CCP) on OHV	6%	20%	22%	20%	20%
Discrete Variable Valve Lift (DVVL) on OHV	0%	14%	16%	19%	20%
Conversion to DOHC with DCP	0%	0%	0%	0%	0%
Stoichiometric Gasoline Direct Injection (GDI)	29%	45%	56%	60%	64%
Combustion Restart	0%	0%	7%	15%	21%
Turbocharging and Downsizing	24%	41%	51%	54%	59%
Exhaust Gas Recirculation (EGR) Boost	0%	17%	29%	31%	43%
Conversion to Diesel following TRBDS	3%	7%	10%	17%	18%
Conversion to Diesel following CBRST	1%	2%	2%	3%	4%
6-Speed Manual/Improved Internals	1%	1%	1%	1%	2%
Improved Auto. Trans. Controls/Externals	35%	29%	26%	11%	1%
Continuously Variable Transmission	3%	3%	1%	1%	1%

6/7/8-Speed Auto. Trans with Improved Internals	8%	3%	0%	0%	0%
Dual Clutch or Automated Manual Transmission	28%	46%	61%	77%	86%
Electric Power Steering	60%	85%	96%	97%	98%
Improved Accessories	38%	48%	60%	59%	59%
12V Micro-Hybrid	0%	0%	0%	0%	0%
Belt mounted Integrated Starter Generator	16%	19%	28%	30%	33%
Crank mounted Integrated Starter Generator	3%	3%	5%	6%	6%
Power Split Hybrid	4%	6%	9%	9%	9%
2-Mode Hybrid	0%	1%	1%	1%	1%
Plug-in Hybrid	0%	0%	0%	0%	0%
Mass Reduction (1.5%)	42%	68%	84%	90%	93%
Mass Reduction (3.5% to 8.5%)	0%	0%	20%	37%	54%
Low Rolling Resistance Tires	85%	92%	95%	95%	95%
Low Drag Brakes	37%	64%	76%	79%	81%
Secondary Axle Disconnect - Unibody	0%	0%	0%	0%	0%
Secondary Axle Disconnect - Ladder Frame	39%	50%	53%	58%	58%
Aero Drag Reduction	86%	91%	95%	97%	100%

VI. MANUFACTURER CAFE CAPABILITIES

Table VI-1 shows the agencies forecast of where the manufacturers passenger car mpg would be, based on the MY 2008 vehicles extended into the future. These mpg estimates change for some of the model years, but usually to a minimal extent, based on changes in sales forecasts between passenger cars and light trucks.

Table VI-2 shows the **ADJUSTED BASELINE** for passenger cars. Note that when we do cost and benefit analyses, we use the **ADJUSTED BASELINE** throughout the analysis. The adjusted baseline is essentially taking the manufacturer's MY 2008 fleet and making it meet the MY 2011 fuel economy standard by adding technology. The adjusted baseline assumes for the analysis that each manufacturer, below the MY 2011 standard applicable to that manufacturer, (except Daimler, Porsche and Volkswagen) would apply technology to achieve the MY 2011 standard. Our rationale for this adjustment of the baseline is that the costs and benefits of achieving MY 2011 mpg levels have already been analyzed and estimated in the previous analysis. The costs of these technologies are estimated, but they are not considered part of this rule. We then estimate the costs and benefits of going from the adjusted baseline to the level of the alternatives.¹⁶²

The required standard levels are shown in Table VI-3 for passenger cars for the preferred alternative. Table VI-4 provides the estimated achieved mpg levels for passenger cars for each of the alternatives. Tables VI-5 through Table VI-8 provide the same tables for light trucks as Tables VI-1 through VI-4 show for passenger cars.

Note that not all manufacturers are assumed to attempt to "meet" the alternatives. We assume that Daimler, Porsche and Volkswagen would not meet these levels because, for them, the cost of meeting these levels is more than the cost of paying penalties. These manufacturers have shown, in the past, the willingness to pay penalties rather than spend more money to improve the fuel economy of their products.

The agency has performed an analysis of how manufacturers could respond to changes in the alternative CAFE levels. The "Technology Application Analysis" (or the "Volpe Analysis") uses a technology application algorithm to systematically apply consistent cost and performance assumptions to the entire industry, as well as consistent assumptions regarding economic decision-making by manufacturers. The resulting computer model (the CAFE Compliance and Effects Model), developed by technical staff of the DOT Volpe National Transportation Systems Center in consultation with NHTSA staff, is used to help estimate the overall economic impact of the alternative CAFE standards. The Volpe analysis shows the economic impact of the standards in terms of increases in new vehicle prices on a manufacturer-wide, industry-wide, and average per-vehicle basis. Based on these estimates and corresponding estimates of net economic and other benefits, the agency is able to consider alternatives that are economically practicable and technologically feasible.

¹⁶² If the manufacturer's MY 2008 fleet extended mpg level is above the level of the alternative, their mpg is assumed to remain at that level. Some manufacturer's levels go slightly above the required mpg mark for them since some technologies are applied to all models of a particular manufacturer so that the exact level for each manufacturer may be slightly higher than the level of the standard and costs and benefits are estimated to that level.

We note that the Volpe model has been updated and refined with respect to its representation of some fuel-saving technologies, but the model remains fundamentally unchanged. The model has been peer reviewed. The model documentation, including a description of the input assumptions and process, as well as peer review reports, was made available in the rulemaking docket for the August 2005 NPRM.¹⁶³

Our analyses of the potential effects of alternative CAFE standards were founded on two major elements: (1) projections of the technical characteristics and sales volumes of future product offerings and (2) estimates of the applicability and incremental cost and fuel savings associated with different hardware changes—technologies—that might be utilized in response to alternative CAFE standards.

¹⁶³ See Docket Nos. NHTSA-2005-22223-3, 4, 5.

Table VI-1
 MY 2008 Fleet Extended
 Estimated mpg
 Passenger Cars

Manufacturer	MY 2012	MY 2013	MY 2014	MY 2015	MY 2016
BMW	27.2	27.2	27.2	27.2	27.2
Chrysler	28.5	28.4	28.4	28.5	28.5
Daimler	27.2	26.6	26.2	26.4	26.4
Ford	28.2	28.0	28.0	28.0	28.1
General Motors	28.7	28.7	28.7	28.7	28.7
Honda	33.9	34.0	34.0	34.1	34.1
Hyundai	31.3	31.4	31.5	31.6	31.6
Kia	31.9	31.9	32.0	32.0	32.1
Mazda	30.9	30.8	30.9	30.9	31.0
Mitsubishi	30.0	29.9	30.0	30.0	30.1
Nissan	31.7	31.6	31.6	31.6	31.7
Porsche	26.2	26.2	26.2	26.2	26.2
Subaru	29.2	29.2	29.2	29.2	29.2
Suzuki	30.4	30.5	30.4	30.4	30.5
Tata	24.6	24.6	24.6	24.6	24.6
Toyota	35.5	35.4	35.4	35.4	35.4
Volkswagen	28.7	28.6	28.4	28.3	28.3
Total/Average	30.8	30.8	30.9	30.9	30.9

Table VI-2
Adjusted Baseline
Estimated mpg
Passenger Cars

Manufacturer	MY 2012	MY 2013	MY 2014	MY 2015	MY 2016
BMW	30.2	30.2	30.2	30.2	30.2
Chrysler	29.8	29.7	29.7	29.5	29.5
Daimler	29.1	29.0	29.2	29.4	29.4
Ford	29.9	29.9	29.9	29.9	29.9
General Motors	30.3	30.4	30.4	30.4	30.4
Honda	33.9	34.0	34.0	34.1	34.1
Hyundai	31.3	31.4	31.5	31.6	31.6
Kia	31.9	31.9	32.0	32.0	32.1
Mazda	30.9	30.8	30.9	30.9	31.0
Mitsubishi	31.1	31.0	31.0	31.1	31.1
Nissan	31.7	31.6	31.6	31.6	31.7
Porsche	29.3	30.5	30.5	30.7	30.7
Subaru	31.0	31.0	31.0	31.0	31.0
Suzuki	31.1	31.2	31.1	31.2	31.2
Tata	26.2	28.5	28.5	28.5	28.5
Toyota	35.5	35.4	35.4	35.4	35.4
Volkswagen	30.8	31.0	30.8	30.7	30.7
Total/Average	31.8	31.8	31.9	31.9	32.0

Table VI-3

Estimated Required Fuel Economy Levels for Preferred Alternative

Estimated mpg

Passenger Cars

Manufacturer	MY 2012	MY 2013	MY 2014	MY 2015	MY 2016
BMW	33.2	34.0	34.8	36.0	37.5
Chrysler	33.0	33.7	34.5	35.3	36.8
Daimler	32.6	33.1	33.8	35.0	36.4
Ford	33.0	33.7	34.5	35.8	37.3
General Motors	33.0	33.8	34.6	35.8	37.3
Honda	33.9	34.7	35.5	36.8	38.4
Hyundai	33.8	34.6	35.5	36.8	38.3
Kia	33.6	34.4	35.2	36.5	38.0
Mazda	34.1	34.8	35.7	37.0	38.6
Mitsubishi	34.4	35.3	36.1	37.4	39.1
Nissan	33.5	34.2	35.0	36.2	37.8
Porsche	36.2	37.2	38.1	39.6	41.4
Subaru	34.8	35.7	36.5	37.9	39.6
Suzuki	35.9	36.8	37.7	39.2	41.0
Tata	30.9	31.6	32.4	33.5	34.9
Toyota	34.1	34.9	35.7	37.0	38.6
Volkswagen	34.6	35.4	36.2	37.5	39.1
Total/Average	33.6	34.4	35.2	36.4	38.0

Table VI-4

Estimated Achievable Fuel Economy Levels, by Alternative

Estimated mpg

Passenger Cars

Preferred Alternative

Manufacturer	MY 2012	MY 2013	MY 2014	MY 2015	MY 2016
BMW	31.7	31.7	31.9	32.8	34.0
Chrysler	30.8	33.8	34.9	36.7	36.9
Daimler	29.1	29.0	31.3	32.8	34.4
Ford	32.8	34.3	34.8	35.9	37.3
General Motors	30.3	33.7	34.8	36.2	37.3
Honda	33.9	34.7	36.1	36.8	38.4
Hyundai	34.2	34.6	35.7	37.4	38.3
Kia	33.8	34.4	35.3	36.5	38.0
Mazda	32.5	34.8	36.7	37.1	38.6
Mitsubishi	33.4	33.5	36.3	39.0	39.1
Nissan	33.5	34.2	36.1	37.0	37.8
Porsche	29.4	30.7	30.7	30.7	30.7
Subaru	32.4	33.0	36.5	39.8	39.8
Suzuki	31.1	36.8	38.8	39.9	41.4
Tata	26.4	28.7	29.4	29.9	32.3
Toyota	35.5	35.4	36.0	38.0	38.6
Volkswagen	31.4	33.2	33.3	33.5	35.2
Total/Average	32.9	34.2	35.2	36.5	37.6

Estimated Achievable Fuel Economy Levels, by Alternative

Estimated mpg

Passenger Cars

3% Annual Increase

Manufacturer	MY 2012	MY 2013	MY 2014	MY 2015	MY 2016
BMW	31.1	31.1	31.8	32.8	34.0
Chrysler	30.8	32.6	33.5	34.4	34.6
Daimler	29.1	29.0	31.3	32.8	33.9
Ford	31.0	33.0	33.2	34.1	35.0
General Motors	30.3	32.4	33.3	34.3	35.1
Honda	33.9	34.0	34.6	35.1	36.0
Hyundai	32.7	33.3	34.2	35.7	36.2
Kia	31.9	33.0	33.9	35.1	35.7
Mazda	31.9	33.4	34.9	35.2	36.2
Mitsubishi	33.2	33.3	35.1	36.6	36.6
Nissan	31.8	33.0	33.8	35.4	35.6
Porsche	29.4	30.7	30.7	30.7	30.7
Subaru	32.4	33.0	35.5	37.2	37.2
Suzuki	31.1	35.3	37.8	38.1	38.5
Tata	26.4	28.7	29.4	29.9	32.3
Toyota	35.5	35.4	35.4	35.4	36.2
Volkswagen	31.4	33.2	33.3	33.5	35.2
Total/ Average	32.2	33.3	34.0	34.7	35.5

Estimated Achievable Fuel Economy Levels, by Alternative

Estimated mpg

Passenger Cars

4% Annual Increase

Manufacturer	MY 2012	MY 2013	MY 2014	MY 2015	MY 2016
BMW	31.7	31.7	31.9	32.8	34.0
Chrysler	30.8	33.4	34.6	35.9	36.2
Daimler	29.1	29.0	31.3	32.8	34.4
Ford	31.6	33.9	34.2	35.4	36.7
General Motors	30.3	33.0	34.2	35.6	36.7
Honda	33.9	34.0	35.7	36.5	37.8
Hyundai	33.3	33.8	35.1	37.0	37.8
Kia	32.2	33.9	35.1	36.1	37.5
Mazda	32.5	34.2	36.4	36.8	38.0
Mitsubishi	33.4	33.5	35.8	38.4	38.5
Nissan	32.2	33.4	35.8	36.6	37.2
Porsche	29.4	30.7	30.7	30.7	30.7
Subaru	32.4	33.0	36.2	39.3	39.3
Suzuki	31.1	36.1	38.4	39.4	40.6
Tata	26.4	28.7	29.4	29.9	32.3
Toyota	35.5	35.4	35.7	37.4	38.1
Volkswagen	31.4	33.2	33.3	33.5	35.2
Total/ Average	32.4	33.7	34.8	36.0	37.1

Estimated Achievable Fuel Economy Levels, by Alternative

Estimated mpg

Passenger Cars

5% Annual Increase

Manufacturer	MY 2012	MY 2013	MY 2014	MY 2015	MY 2016
BMW	31.7	31.7	31.9	32.8	34.0
Chrysler	30.8	34.2	35.7	37.8	38.0
Daimler	29.1	29.0	31.3	32.8	34.4
Ford	32.1	34.9	35.4	36.9	38.5
General Motors	30.3	33.7	35.3	36.9	38.5
Honda	33.9	35.3	37.3	37.9	39.7
Hyundai	34.1	34.5	36.6	38.6	39.7
Kia	32.8	34.7	36.0	37.7	39.3
Mazda	32.5	34.9	37.4	38.0	40.0
Mitsubishi	33.4	33.5	36.8	41.3	41.3
Nissan	32.5	34.0	36.8	38.2	39.0
Porsche	29.4	30.7	30.7	30.7	30.7
Subaru	32.4	33.0	37.3	41.0	41.0
Suzuki	31.1	36.8	40.8	42.2	42.9
Tata	26.4	28.7	29.4	29.9	32.3
Toyota	35.5	35.8	37.1	38.1	40.0
Volkswagen	31.4	33.2	33.3	33.5	35.2
Total/Average	32.6	34.4	35.9	37.2	38.7

Estimated Achievable Fuel Economy Levels, by Alternative

Estimated mpg

Passenger Cars

6% Annual Increase

Manufacturer	MY 2012	MY 2013	MY 2014	MY 2015	MY 2016
BMW	31.7	31.7	31.9	32.8	34.0
Chrysler	30.8	34.8	36.9	39.5	39.5
Daimler	29.1	29.0	31.3	32.8	34.4
Ford	32.4	35.8	36.2	37.7	39.3
General Motors	30.3	33.7	36.1	38.4	40.2
Honda	33.9	36.0	38.8	39.5	41.6
Hyundai	34.4	34.8	38.2	39.6	41.7
Kia	33.0	35.4	37.1	39.2	41.2
Mazda	32.5	35.5	38.3	39.0	41.9
Mitsubishi	33.4	33.5	39.5	41.9	41.9
Nissan	33.2	34.7	38.5	39.9	40.9
Porsche	29.4	30.7	30.7	30.7	30.7
Subaru	32.4	33.0	38.7	41.1	41.1
Suzuki	31.1	37.7	41.4	42.3	43.0
Tata	26.4	28.7	29.4	29.9	32.3
Toyota	35.5	36.6	38.2	39.9	41.9
Volkswagen	31.4	33.2	33.3	33.5	35.2
Total/Average	32.7	34.9	36.9	38.4	40.1

Estimated Achievable Fuel Economy Levels, by Alternative

Estimated mpg

Passenger Cars

7% Annual Increase

Manufacturer	MY 2012	MY 2013	MY 2014	MY 2015	MY 2016
BMW	31.7	31.7	31.9	32.8	34.0
Chrysler	30.8	35.3	38.1	39.6	39.6
Daimler	29.1	29.0	31.3	32.8	34.4
Ford	32.7	36.0	36.2	37.7	39.3
General Motors	30.3	33.7	36.1	38.6	40.4
Honda	34.0	36.6	40.3	41.0	43.7
Hyundai	34.3	34.8	39.4	41.8	43.8
Kia	33.4	35.9	38.2	41.1	43.2
Mazda	32.5	36.0	38.3	39.0	43.4
Mitsubishi	33.4	33.5	39.2	42.0	42.1
Nissan	33.5	35.3	39.5	39.8	40.7
Porsche	29.4	30.7	30.7	30.7	30.7
Subaru	32.4	33.0	39.0	41.5	41.5
Suzuki	31.1	37.9	41.1	41.8	42.9
Tata	26.4	28.7	29.4	29.9	32.3
Toyota	36.0	37.6	39.0	41.4	44.0
Volkswagen	31.4	33.2	33.3	33.5	35.2
Total/Average	32.9	35.3	37.5	39.0	41.0

Estimated Achievable Fuel Economy Levels, by Alternative

Estimated mpg

Passenger Cars

Max Net Benefits

Manufacturer	MY 2012	MY 2013	MY 2014	MY 2015	MY 2016
BMW	31.7	31.7	31.9	32.8	34.0
Chrysler	30.8	35.4	37.4	39.4	39.4
Daimler	29.1	29.0	31.3	32.8	34.4
Ford	32.8	36.1	36.4	38.0	39.5
General Motors	30.3	33.7	36.1	38.6	40.1
Honda	34.0	36.7	39.5	40.0	41.5
Hyundai	34.4	34.8	38.7	39.9	41.3
Kia	33.4	36.3	38.1	39.7	41.0
Mazda	32.5	36.1	38.4	39.1	41.6
Mitsubishi	33.4	33.5	39.2	41.8	41.8
Nissan	33.5	35.3	39.1	39.8	40.6
Porsche	29.4	30.7	30.7	30.7	30.7
Subaru	32.4	33.0	39.0	41.4	41.3
Suzuki	31.1	37.9	41.1	41.8	42.9
Tata	26.4	28.7	29.4	29.9	32.3
Toyota	36.3	37.9	38.8	40.5	41.7
Volkswagen	31.4	33.2	33.3	33.5	35.2
Total/Average	33.0	35.4	37.3	38.7	40.0

Estimated Achievable Fuel Economy Levels, by Alternative

Estimated mpg

Passenger Cars

Total Cost=Total Benefit

Manufacturer	MY 2012	MY 2013	MY 2014	MY 2015	MY 2016
BMW	31.7	31.7	31.9	32.8	34.0
Chrysler	30.8	36.3	38.5	39.4	39.4
Daimler	29.1	29.0	31.3	32.8	34.4
Ford	32.8	36.2	36.5	38.0	39.6
General Motors	30.3	33.7	36.1	38.6	40.4
Honda	34.5	37.6	40.8	41.3	43.9
Hyundai	34.6	35.0	39.9	41.3	43.1
Kia	33.8	36.7	39.3	41.2	42.7
Mazda	32.5	36.1	38.4	39.1	43.5
Mitsubishi	33.4	33.5	39.2	42.0	42.0
Nissan	33.5	35.2	39.4	39.8	40.6
Porsche	29.4	30.7	30.7	30.7	30.7
Subaru	32.4	33.0	39.0	41.5	41.5
Suzuki	31.1	37.9	41.1	41.8	42.9
Tata	26.4	28.7	29.4	29.9	32.3
Toyota	37.1	38.7	39.7	41.6	43.5
Volkswagen	31.4	33.2	33.3	33.5	35.2
Total/ Average	33.2	35.6	37.8	39.2	40.9

Table VI-5

MY 2008 Fleet Extended

Estimated mpg

Light Trucks

Manufacturer	MY 2012	MY 2013	MY 2014	MY 2015	MY 2016
BMW	23.0	22.9	22.9	22.9	22.9
Chrysler	22.1	22.1	22.0	21.8	21.8
Daimler	21.2	21.2	21.1	21.1	21.1
Ford	20.8	20.8	20.7	20.7	20.7
General Motors	21.0	21.1	21.0	21.0	21.0
Honda	25.1	24.9	24.8	24.8	24.8
Hyundai	24.3	24.2	24.2	24.2	24.2
Kia	23.7	23.7	23.7	23.7	23.7
Mazda	27.2	26.9	26.6	26.3	26.3
Mitsubishi	23.6	23.4	23.4	23.4	23.4
Nissan	21.8	22.0	21.8	21.7	21.7
Porsche	20.0	20.0	20.0	20.0	20.0
Subaru	26.2	26.3	26.6	26.6	26.7
Suzuki	23.3	23.3	23.3	23.3	23.3
Tata	19.4	19.3	19.3	19.3	19.3
Toyota	24.6	24.6	24.7	24.6	24.5
Volkswagen	20.2	20.2	20.2	20.2	20.2
Total/ Average	22.4	22.4	22.3	22.3	22.3

Table VI-6
Adjusted Baseline
Estimated mpg
Light Trucks

Manufacturer	MY 2012	MY 2013	MY 2014	MY 2015	MY 2016
BMW	26.1	25.9	25.8	25.8	25.8
Chrysler	24.3	24.4	24.3	24.1	24.1
Daimler	24.9	25.1	25.0	25.0	25.0
Ford	23.5	23.6	23.4	23.3	23.3
General Motors	22.7	23.0	22.9	22.9	22.9
Honda	25.7	25.5	25.5	25.7	25.6
Hyundai	26.0	25.9	25.9	26.0	26.0
Kia	25.1	25.1	25.1	25.1	25.1
Mazda	27.2	26.9	26.6	26.3	26.3
Mitsubishi	26.4	26.4	26.4	26.4	26.4
Nissan	24.2	24.3	24.0	24.0	24.0
Porsche	24.4	24.4	24.4	25.7	25.7
Subaru	27.0	27.0	27.2	27.3	27.3
Suzuki	24.7	26.3	26.3	26.3	26.3
Tata	24.4	24.2	24.1	24.6	26.2
Toyota	25.0	25.0	25.1	25.0	25.0
Volkswagen	21.1	23.2	24.6	24.6	24.9
Total/ Average	24.2	24.3	24.2	24.1	24.2

Table VI-7

Estimated Required Fuel Economy Levels for Preferred Alternative

Estimated mpg

Light Trucks

Manufacturer	MY 2012	MY 2013	MY 2014	MY 2015	MY 2016
BMW	26.3	27.0	27.7	28.8	30.1
Chrysler	25.2	25.8	26.4	27.3	28.5
Daimler	25.4	26.1	26.9	27.9	29.1
Ford	24.3	24.9	25.3	26.2	27.3
General Motors	23.6	24.2	24.8	25.6	26.6
Honda	26.4	27.1	27.9	29.0	30.4
Hyundai	26.6	27.3	28.1	29.3	30.6
Kia	25.8	26.4	27.2	28.3	29.6
Mazda	27.4	28.1	28.8	29.9	31.4
Mitsubishi	27.4	28.1	28.9	30.1	31.6
Nissan	25.0	25.6	26.1	27.0	28.2
Porsche	26.0	26.7	27.4	28.5	29.8
Subaru	27.5	28.3	29.2	30.4	31.8
Suzuki	27.2	27.9	28.7	29.9	31.3
Tata	26.9	27.6	28.4	29.6	31.0
Toyota	25.7	26.3	27.1	28.1	29.3
Volkswagen	25.6	26.2	26.9	27.9	29.2
Total/ Average	25.0	25.6	26.2	27.1	28.3

Table VI-8

Estimated Achievable Fuel Economy Levels, by Alternative

Estimated mpg

Light Trucks

Preferred Alternative

Manufacturer	MY 2012	MY 2013	MY 2014	MY 2015	MY 2016
BMW	27.4	27.2	27.3	28.7	29.3
Chrysler	24.3	26.0	27.1	27.3	28.5
Daimler	25.5	25.7	25.8	26.1	26.1
Ford	24.6	25.2	25.3	27.1	27.3
General Motors	22.7	24.4	25.5	25.7	26.6
Honda	27.4	27.3	28.2	29.1	30.4
Hyundai	27.4	27.4	28.9	30.7	30.7
Kia	25.8	26.4	27.2	28.3	29.7
Mazda	27.5	28.9	29.2	30.9	31.4
Mitsubishi	26.4	26.4	29.4	30.3	31.7
Nissan	25.2	25.7	26.5	27.0	28.2
Porsche	24.4	24.4	24.4	28.0	28.0
Subaru	28.6	28.8	30.2	31.6	31.8
Suzuki	24.7	28.7	31.0	31.0	31.3
Tata	24.4	24.2	24.1	24.6	27.2
Toyota	25.7	26.3	27.8	28.8	29.3
Volkswagen	21.1	23.2	24.6	24.6	24.9
Total/Average	24.9	25.7	26.5	27.4	28.1

Estimated Achievable Fuel Economy Levels, by Alternative

Estimated mpg

Light Trucks

3% Annual Increase

Manufacturer	MY 2012	MY 2013	MY 2014	MY 2015	MY 2016
BMW	26.1	26.7	26.7	27.6	28.2
Chrysler	24.3	25.0	25.9	26.0	26.7
Daimler	24.9	25.0	25.1	26.1	26.1
Ford	23.8	24.3	24.4	25.7	25.7
General Motors	22.7	23.7	24.3	24.4	25.1
Honda	26.1	25.9	26.9	27.9	28.4
Hyundai	26.1	26.1	27.4	28.6	28.6
Kia	25.1	25.3	26.1	26.9	27.8
Mazda	27.2	27.6	28.2	28.6	29.3
Mitsubishi	26.4	26.4	28.5	28.7	29.5
Nissan	24.2	24.7	25.6	26.0	26.5
Porsche	24.4	24.4	24.4	28.0	28.0
Subaru	27.0	27.0	29.1	29.6	29.7
Suzuki	24.7	29.0	29.0	29.0	29.2
Tata	24.4	24.2	24.1	24.6	27.2
Toyota	25.0	25.2	26.2	26.8	27.5
Volkswagen	21.1	23.2	24.6	24.6	24.9
Total/ Average	24.3	24.8	25.4	26.0	26.5

Estimated Achievable Fuel Economy Levels, by Alternative

Estimated mpg

Light Trucks

4% Annual Increase

Manufacturer	MY 2012	MY 2013	MY 2014	MY 2015	MY 2016
BMW	26.9	26.7	26.8	28.5	29.1
Chrysler	24.3	25.4	26.8	27.0	28.1
Daimler	24.9	25.0	25.1	26.1	26.1
Ford	24.0	24.8	25.1	26.8	26.9
General Motors	22.7	24.1	25.2	25.4	26.3
Honda	26.7	26.5	27.9	28.9	29.9
Hyundai	26.8	26.8	28.6	30.1	30.1
Kia	25.1	25.8	27.0	28.0	29.3
Mazda	27.2	28.5	29.4	29.7	31.0
Mitsubishi	26.4	26.4	29.0	29.9	31.3
Nissan	24.8	25.4	26.3	26.9	27.9
Porsche	24.4	24.4	24.4	28.0	28.0
Subaru	28.0	28.1	30.0	31.2	31.3
Suzuki	24.7	29.2	30.1	30.1	30.8
Tata	24.4	24.2	24.1	24.6	27.2
Toyota	25.1	25.7	27.5	28.3	28.9
Volkswagen	21.1	23.2	24.6	24.6	24.9
Total/ Average	24.5	25.2	26.3	27.1	27.7

Estimated Achievable Fuel Economy Levels, by Alternative

Estimated mpg

Light Trucks

5% Annual Increase

Manufacturer	MY 2012	MY 2013	MY 2014	MY 2015	MY 2016
BMW	26.9	26.7	26.8	28.6	29.3
Chrysler	24.3	25.9	27.7	28.1	29.4
Daimler	25.0	25.0	25.2	26.1	26.1
Ford	24.3	25.1	25.5	28.1	28.3
General Motors	22.7	24.5	25.9	26.3	27.5
Honda	27.1	26.9	29.0	30.4	31.8
Hyundai	27.2	27.2	29.4	32.1	32.1
Kia	25.1	26.3	27.7	29.2	31.1
Mazda	27.3	29.4	30.2	31.0	32.5
Mitsubishi	26.4	26.4	29.6	30.5	33.3
Nissan	25.1	26.1	27.4	27.8	29.1
Porsche	24.4	24.4	24.4	28.0	28.0
Subaru	28.3	28.4	31.5	31.9	32.0
Suzuki	24.7	29.3	31.8	31.8	32.6
Tata	24.4	24.2	24.1	24.6	27.2
Toyota	25.2	26.3	28.4	29.5	30.3
Volkswagen	21.1	23.2	24.6	24.6	24.9
Total/ Average	24.6	25.7	27.0	28.2	29.0

Estimated Achievable Fuel Economy Levels, by Alternative

Estimated mpg

Light Trucks

6% Annual Increase

Manufacturer	MY 2012	MY 2013	MY 2014	MY 2015	MY 2016
BMW	26.9	26.7	26.8	28.6	29.3
Chrysler	24.3	26.2	28.7	29.2	30.9
Daimler	25.2	25.4	25.4	26.1	26.1
Ford	24.5	25.1	25.4	29.3	29.8
General Motors	22.7	25.1	26.8	27.5	28.7
Honda	27.5	27.3	30.5	31.4	33.1
Hyundai	27.8	27.9	30.9	32.5	32.5
Kia	25.3	26.8	28.4	30.1	32.5
Mazda	27.6	30.3	31.2	33.3	34.4
Mitsubishi	26.4	26.4	29.6	30.5	34.8
Nissan	25.4	26.5	28.2	28.7	29.9
Porsche	24.4	24.4	24.4	28.0	28.0
Subaru	28.8	28.9	32.1	32.3	32.4
Suzuki	24.7	30.8	32.3	32.3	33.7
Tata	24.4	24.2	24.1	24.6	27.2
Toyota	25.5	26.7	29.4	30.7	31.9
Volkswagen	21.1	23.2	24.6	24.6	24.9
Total/ Average	24.8	26.0	27.6	29.2	30.3

Estimated Achievable Fuel Economy Levels, by Alternative

Estimated mpg

Light Trucks

7% Annual Increase

Manufacturer	MY 2012	MY 2013	MY 2014	MY 2015	MY 2016
BMW	27.2	27.0	27.1	28.6	29.3
Chrysler	24.3	26.7	29.1	29.3	32.1
Daimler	25.4	25.6	25.7	26.1	26.1
Ford	24.9	25.6	25.8	30.2	30.8
General Motors	22.7	25.5	27.6	28.4	29.3
Honda	27.8	27.6	31.2	31.9	33.5
Hyundai	28.2	28.3	31.5	32.2	32.2
Kia	25.5	26.9	28.4	30.1	33.8
Mazda	28.2	31.2	32.2	34.7	36.1
Mitsubishi	26.4	26.4	29.6	30.5	35.6
Nissan	25.8	26.6	28.2	28.7	29.9
Porsche	24.4	24.4	24.4	28.0	28.0
Subaru	29.1	29.3	33.0	33.2	33.3
Suzuki	24.7	31.7	33.6	34.6	36.2
Tata	24.4	24.2	24.1	24.6	27.2
Toyota	25.7	27.2	30.4	31.9	33.6
Volkswagen	21.1	23.2	24.6	24.6	24.9
Total/ Average	25.0	26.4	28.2	29.9	31.0

Estimated Achievable Fuel Economy Levels, by Alternative

Estimated mpg

Light Trucks

Max Net Benefits

Manufacturer	MY 2012	MY 2013	MY 2014	MY 2015	MY 2016
BMW	28.4	28.6	28.7	29.0	29.7
Chrysler	24.3	26.8	28.8	29.2	30.8
Daimler	25.6	25.8	25.9	26.2	26.2
Ford	25.4	25.9	26.0	29.2	29.4
General Motors	22.7	26.2	27.7	28.2	28.7
Honda	29.0	28.8	32.0	32.4	33.2
Hyundai	29.3	29.4	32.2	33.6	33.6
Kia	25.9	26.9	28.4	30.1	32.6
Mazda	29.5	32.3	33.2	33.6	34.3
Mitsubishi	26.4	26.4	29.6	30.5	34.8
Nissan	26.4	27.1	28.8	28.8	30.1
Porsche	24.4	24.4	24.4	28.0	28.0
Subaru	30.9	31.1	33.1	33.2	33.4
Suzuki	24.7	32.7	33.6	33.6	34.2
Tata	24.4	24.2	24.1	24.6	27.2
Toyota	26.2	28.3	30.6	31.8	32.2
Volkswagen	21.1	23.2	24.6	24.6	24.9
Total/ Average	25.4	27.1	28.5	29.7	30.3

Estimated Achievable Fuel Economy Levels, by Alternative

Estimated mpg

Light Trucks

Total Cost=Total Benefit

Manufacturer	MY 2012	MY 2013	MY 2014	MY 2015	MY 2016
BMW	28.9	28.7	28.8	29.0	29.7
Chrysler	24.3	26.8	28.8	29.2	31.7
Daimler	25.6	25.8	25.9	26.2	26.2
Ford	25.4	25.9	26.0	29.7	30.2
General Motors	22.7	26.4	28.2	28.8	29.2
Honda	29.2	29.0	32.3	32.5	34.1
Hyundai	29.7	29.8	33.4	33.7	33.7
Kia	25.9	26.9	28.4	30.1	33.8
Mazda	29.5	33.1	34.2	34.6	35.3
Mitsubishi	26.4	26.4	29.6	30.5	35.6
Nissan	26.4	27.0	28.8	28.8	30.0
Porsche	24.4	24.4	24.4	28.0	28.0
Subaru	31.1	31.3	33.7	33.8	33.9
Suzuki	24.7	32.7	34.6	34.6	35.3
Tata	24.4	24.2	24.1	24.6	27.2
Toyota	26.2	28.3	31.5	32.3	32.9
Volkswagen	21.1	23.2	24.6	24.6	24.9
Total/ Average	25.5	27.2	28.8	30.1	30.8

VII. COST IMPACTS

The technology application algorithm implemented with the Volpe model was used as the basis for estimating costs for the fleet. The agency did estimate the costs or fines to bring passenger car manufacturers up to the MY 2011 standards from their MY 2008 levels, as shown in Table VII-1a and VII-1b for passenger cars and light trucks. These costs have been estimated, but they are not considered to be part of the costs of meeting the proposed requirements. These costs, and commensurate benefits, are considered part of the costs and benefits of complying with previously issued rules.

Tables VII-2a to 2o show the estimated cost per vehicle and incremental total costs in millions for the various alternatives for passenger cars. Tables VII-3a to 3o show the estimated cost per vehicle and incremental total costs in millions for the various alternatives for light trucks. The costs for several manufacturers are the fines that these manufacturers would have to pay on an average vehicle basis. We assume that the costs of fines will be passed on to consumers. The incremental total cost tables show the estimated total manufacturer costs in millions of dollars. Fines are not included in these tables, since these are transfer payments and not technology costs.

Table VII-1a
 Estimated Incremental Costs or Fines over Manufacturer's Plans
 To get to Adjusted Baseline
 Average Cost per Vehicle (2007\$)
 Passenger Cars

Manufacturer	MY 2012	MY 2013	MY 2014	MY 2015	MY 2016
BMW	\$574	\$560	\$547	\$533	\$520
Chrysler	\$151	\$155	\$150	\$119	\$114
Daimler	\$325	\$420	\$496	\$484	\$476
Ford	\$176	\$187	\$183	\$175	\$169
General Motors	\$403	\$402	\$404	\$400	\$396
Honda	\$0	\$0	\$0	\$0	\$0
Hyundai	\$0	\$0	\$0	\$0	\$0
Kia	\$0	\$0	\$0	\$0	\$0
Mazda	\$0	\$0	\$0	\$0	\$0
Mitsubishi	\$125	\$119	\$118	\$117	\$115
Nissan	\$0	\$0	\$0	\$0	\$0
Porsche	\$933	\$1,230	\$1,203	\$1,165	\$1,138
Subaru	\$219	\$213	\$202	\$197	\$190
Suzuki	\$51	\$44	\$44	\$44	\$43
Tata	\$476	\$955	\$931	\$906	\$882
Toyota	\$0	\$0	\$0	\$0	\$0
Volkswagen	\$297	\$312	\$306	\$305	\$299
Total/Average	\$140	\$147	\$146	\$143	\$141

Table VII-1b
 Estimated Incremental Costs or Fines over Manufacturer's Plans
 To get to Adjusted Baseline
 Average Cost per Vehicle (2007\$)
 Light Trucks

Manufacturer	MY 2012	MY 2013	MY 2014	MY 2015	MY 2016
BMW	\$781	\$711	\$685	\$666	\$646
Chrysler	\$606	\$602	\$611	\$593	\$582
Daimler	\$997	\$981	\$970	\$946	\$926
Ford	\$567	\$514	\$483	\$471	\$461
General Motors	\$648	\$708	\$708	\$699	\$687
Honda	\$60	\$60	\$59	\$71	\$72
Hyundai	\$157	\$156	\$153	\$151	\$146
Kia	\$113	\$109	\$106	\$103	\$100
Mazda	\$0	\$0	\$0	\$0	\$0
Mitsubishi	\$610	\$643	\$637	\$618	\$601
Nissan	\$520	\$481	\$456	\$453	\$438
Porsche	\$1,257	\$1,208	\$1,184	\$1,612	\$1,588
Subaru	\$66	\$61	\$53	\$50	\$47
Suzuki	\$650	\$694	\$677	\$659	\$643
Tata	\$1,567	\$1,533	\$1,505	\$1,543	\$2,002
Toyota	\$25	\$24	\$23	\$22	\$22
Volkswagen	\$430	\$848	\$1,293	\$1,282	\$1,291
Total/Average	\$411	\$421	\$424	\$413	\$409

Table VII-2a
 Estimated Incremental Costs or Fines over Adjusted Baseline
 Average Cost per Vehicle (2007\$)
 Passenger Cars

**Preferred Alternative
 Average Cost per Vehicle**

Manufacturer	MY 2012	MY 2013	MY 2014	MY 2015	MY 2016
BMW	\$524	\$552	\$634	\$828	\$1,124
Chrysler	\$775	\$1,304	\$1,473	\$1,583	\$1,582
Daimler	\$182	\$215	\$781	\$1,039	\$1,401
Ford	\$1,746	\$1,719	\$1,735	\$1,880	\$2,078
General Motors	\$143	\$990	\$1,189	\$1,387	\$1,553
Honda	\$31	\$122	\$205	\$287	\$494
Hyundai	\$418	\$452	\$643	\$726	\$868
Kia	\$319	\$359	\$387	\$473	\$647
Mazda	\$658	\$735	\$965	\$991	\$1,263
Mitsubishi	\$1,156	\$1,076	\$1,715	\$2,076	\$2,035
Nissan	\$653	\$712	\$1,155	\$1,153	\$1,275
Porsche	\$270	\$256	\$306	\$399	\$498
Subaru	\$408	\$465	\$1,493	\$1,877	\$1,838
Suzuki	\$259	\$1,001	\$1,445	\$1,494	\$1,675
Tata	\$246	\$244	\$395	\$577	\$1,284
Toyota	\$133	\$127	\$155	\$257	\$267
Volkswagen	\$286	\$561	\$650	\$767	\$1,125
Total/Average	\$498	\$674	\$820	\$930	\$1,085

Table VII-2b
 Estimated Incremental Costs or Fines over Adjusted Baseline
 Total Incremental Costs in Millions (2007\$)
 Passenger Cars

**Preferred Alternative
 Total Incremental Costs**

Manufacturer	MY 2012	MY 2013	MY 2014	MY 2015	MY 2016
BMW	\$149	\$178	\$223	\$308	\$428
Chrysler	\$139	\$228	\$249	\$216	\$219
Daimler	\$31	\$41	\$160	\$238	\$330
Ford	\$2,354	\$2,448	\$2,510	\$2,826	\$3,140
General Motors	\$212	\$1,604	\$2,031	\$2,482	\$2,827
Honda	\$35	\$165	\$306	\$448	\$788
Hyundai	\$243	\$253	\$362	\$429	\$518
Kia	\$97	\$111	\$128	\$164	\$227
Mazda	\$206	\$234	\$327	\$337	\$436
Mitsubishi	\$75	\$66	\$97	\$109	\$109
Nissan	\$626	\$734	\$1,239	\$1,273	\$1,433
Porsche	\$9	\$9	\$12	\$14	\$18
Subaru	\$61	\$63	\$202	\$245	\$241
Suzuki	\$22	\$86	\$118	\$114	\$130
Tata	\$6	\$8	\$14	\$23	\$53
Toyota	\$226	\$237	\$307	\$544	\$576
Volkswagen	\$121	\$257	\$304	\$357	\$536
Total/ Average	\$4,611	\$6,724	\$8,588	\$10,129	\$12,009

Table VII-2c
 Estimated Incremental Costs or Fines over Adjusted Baseline
 Average Cost per Vehicle (2007\$)
 Passenger Cars

**3% Annual Increase
 Average Cost per Vehicle**

Manufacturer	MY 2012	MY 2013	MY 2014	MY 2015	MY 2016
BMW	\$524	\$552	\$634	\$828	\$1,124
Chrysler	\$775	\$1,304	\$1,473	\$1,583	\$1,582
Daimler	\$182	\$215	\$781	\$1,039	\$1,401
Ford	\$1,746	\$1,719	\$1,735	\$1,880	\$2,078
General Motors	\$143	\$990	\$1,189	\$1,387	\$1,553
Honda	\$31	\$122	\$205	\$287	\$494
Hyundai	\$418	\$452	\$643	\$726	\$868
Kia	\$319	\$359	\$387	\$473	\$647
Mazda	\$658	\$735	\$965	\$991	\$1,263
Mitsubishi	\$1,156	\$1,076	\$1,715	\$2,076	\$2,035
Nissan	\$653	\$712	\$1,155	\$1,153	\$1,275
Porsche	\$270	\$256	\$306	\$399	\$498
Subaru	\$408	\$465	\$1,493	\$1,877	\$1,838
Suzuki	\$259	\$1,001	\$1,445	\$1,494	\$1,675
Tata	\$246	\$244	\$395	\$577	\$1,284
Toyota	\$133	\$127	\$155	\$257	\$267
Volkswagen	\$286	\$561	\$650	\$767	\$1,125
Total/Average	\$498	\$674	\$820	\$930	\$1,085

Table VII-2d
 Estimated Incremental Costs or Fines over Adjusted Baseline
 Total Incremental Costs in Millions (2007\$)
 Passenger Cars

**3% Annual Increase
 Total Incremental Costs**

Manufacturer	MY 2012	MY 2013	MY 2014	MY 2015	MY 2016
BMW	\$117	\$154	\$186	\$275	\$381
Chrysler	\$119	\$167	\$182	\$149	\$151
Daimler	\$12	\$27	\$145	\$218	\$269
Ford	\$472	\$851	\$896	\$1,183	\$1,423
General Motors	\$49	\$665	\$906	\$1,271	\$1,591
Honda	\$32	\$103	\$131	\$194	\$240
Hyundai	\$200	\$217	\$320	\$344	\$375
Kia	\$8	\$35	\$61	\$109	\$142
Mazda	\$54	\$98	\$166	\$176	\$219
Mitsubishi	\$67	\$68	\$77	\$79	\$80
Nissan	\$23	\$239	\$608	\$699	\$733
Porsche	\$4	\$7	\$8	\$10	\$13
Subaru	\$43	\$51	\$124	\$143	\$141
Suzuki	\$11	\$69	\$83	\$78	\$82
Tata	\$3	\$6	\$11	\$20	\$49
Toyota	\$0	\$0	\$0	\$0	\$56
Volkswagen	\$70	\$218	\$266	\$311	\$473
Total/ Average	\$1,286	\$2,974	\$4,171	\$5,261	\$6,418

Table VII-2e
 Estimated Incremental Costs or Fines over Adjusted Baseline
 Average Cost per Vehicle (2007\$)
 Passenger Cars

**4% Annual Increase
 Average Cost per Vehicle**

Manufacturer	MY 2012	MY 2013	MY 2014	MY 2015	MY 2016
BMW	\$447	\$508	\$612	\$806	\$1,096
Chrysler	\$698	\$1,221	\$1,356	\$1,432	\$1,448
Daimler	\$105	\$176	\$764	\$1,022	\$1,374
Ford	\$432	\$867	\$895	\$1,143	\$1,349
General Motors	\$66	\$543	\$763	\$983	\$1,167
Honda	\$29	\$86	\$217	\$281	\$374
Hyundai	\$329	\$364	\$590	\$671	\$786
Kia	\$40	\$197	\$278	\$399	\$545
Mazda	\$575	\$702	\$1,044	\$1,091	\$1,202
Mitsubishi	\$1,072	\$1,167	\$1,617	\$1,933	\$1,897
Nissan	\$227	\$390	\$860	\$915	\$997
Porsche	\$176	\$201	\$284	\$372	\$460
Subaru	\$326	\$416	\$1,293	\$1,698	\$1,671
Suzuki	\$171	\$769	\$1,252	\$1,304	\$1,462
Tata	\$174	\$206	\$373	\$561	\$1,256
Toyota	\$112	\$107	\$111	\$209	\$220
Volkswagen	\$198	\$511	\$628	\$745	\$1,092
Total/Average	\$216	\$418	\$585	\$717	\$849

Table VII-2f
 Estimated Incremental Costs or Fines over Adjusted Baseline
 Total Incremental Costs in Millions (2007\$)
 Passenger Cars

**4% Annual Increase
 Total Incremental Costs**

Manufacturer	MY 2012	MY 2013	MY 2014	MY 2015	MY 2016
BMW	\$127	\$164	\$215	\$300	\$417
Chrysler	\$125	\$214	\$229	\$196	\$201
Daimler	\$18	\$33	\$156	\$235	\$323
Ford	\$583	\$1,234	\$1,294	\$1,718	\$2,038
General Motors	\$98	\$880	\$1,304	\$1,759	\$2,124
Honda	\$33	\$117	\$324	\$439	\$596
Hyundai	\$191	\$203	\$332	\$396	\$469
Kia	\$12	\$61	\$92	\$139	\$191
Mazda	\$180	\$224	\$353	\$371	\$415
Mitsubishi	\$70	\$71	\$91	\$101	\$101
Nissan	\$218	\$402	\$923	\$1,011	\$1,120
Porsche	\$6	\$7	\$11	\$13	\$17
Subaru	\$49	\$57	\$175	\$222	\$219
Suzuki	\$15	\$66	\$102	\$99	\$113
Tata	\$4	\$7	\$13	\$23	\$52
Toyota	\$190	\$200	\$220	\$441	\$474
Volkswagen	\$84	\$234	\$294	\$347	\$520
Total/Average	\$2,001	\$4,175	\$6,130	\$7,808	\$9,393

Table VII-2g
 Estimated Incremental Costs or Fines over Adjusted Baseline
 Average Cost per Vehicle (2007\$)
 Passenger Cars

**5% Annual Increase
 Average Cost per Vehicle**

Manufacturer	MY 2012	MY 2013	MY 2014	MY 2015	MY 2016
BMW	\$474	\$541	\$667	\$883	\$1,190
Chrysler	\$726	\$1,464	\$1,832	\$1,928	\$1,913
Daimler	\$132	\$209	\$814	\$1,094	\$1,467
Ford	\$979	\$1,556	\$1,572	\$1,918	\$2,181
General Motors	\$94	\$934	\$1,242	\$1,541	\$1,808
Honda	\$55	\$263	\$408	\$451	\$671
Hyundai	\$518	\$531	\$943	\$1,007	\$1,152
Kia	\$180	\$344	\$440	\$612	\$796
Mazda	\$603	\$919	\$1,294	\$1,569	\$1,863
Mitsubishi	\$1,106	\$1,141	\$2,594	\$2,962	\$2,913
Nissan	\$298	\$587	\$1,344	\$1,402	\$1,517
Porsche	\$209	\$240	\$350	\$465	\$581
Subaru	\$353	\$454	\$1,828	\$2,258	\$2,201
Suzuki	\$204	\$1,453	\$2,444	\$2,580	\$2,624
Tata	\$202	\$239	\$428	\$632	\$1,350
Toyota	\$133	\$127	\$194	\$285	\$446
Volkswagen	\$231	\$550	\$688	\$828	\$1,202
Total/Average	\$337	\$664	\$916	\$1,079	\$1,291

Table VII-2h
 Estimated Incremental Costs or Fines over Adjusted Baseline
 Total Incremental Costs in Millions (2007\$)
 Passenger Cars

**5% Annual Increase
 Total Incremental Costs**

Manufacturer	MY 2012	MY 2013	MY 2014	MY 2015	MY 2016
BMW	\$135	\$175	\$235	\$328	\$453
Chrysler	\$130	\$256	\$310	\$263	\$265
Daimler	\$23	\$40	\$166	\$251	\$345
Ford	\$1,320	\$2,216	\$2,273	\$2,884	\$3,296
General Motors	\$139	\$1,514	\$2,122	\$2,758	\$3,292
Honda	\$63	\$356	\$610	\$705	\$1,069
Hyundai	\$300	\$297	\$531	\$595	\$688
Kia	\$55	\$106	\$146	\$213	\$279
Mazda	\$189	\$293	\$438	\$534	\$644
Mitsubishi	\$72	\$70	\$146	\$155	\$156
Nissan	\$285	\$605	\$1,443	\$1,548	\$1,704
Porsche	\$7	\$9	\$13	\$17	\$22
Subaru	\$53	\$62	\$247	\$295	\$288
Suzuki	\$18	\$125	\$199	\$196	\$203
Tata	\$5	\$8	\$15	\$26	\$56
Toyota	\$226	\$237	\$386	\$604	\$960
Volkswagen	\$98	\$252	\$322	\$385	\$573
Total/ Average	\$3,115	\$6,620	\$9,601	\$11,756	\$14,292

Table VII-2i
 Estimated Incremental Costs or Fines over Adjusted Baseline
 Average Cost per Vehicle (2007\$)
 Passenger Cars

**6% Annual Increase
 Average Cost per Vehicle**

Manufacturer	MY 2012	MY 2013	MY 2014	MY 2015	MY 2016
BMW	\$491	\$579	\$722	\$960	\$1,294
Chrysler	\$742	\$1,975	\$2,571	\$2,688	\$2,635
Daimler	\$149	\$242	\$863	\$1,165	\$1,561
Ford	\$1,558	\$2,322	\$2,294	\$2,597	\$2,863
General Motors	\$110	\$1,078	\$1,624	\$2,158	\$2,486
Honda	\$58	\$464	\$658	\$718	\$1,048
Hyundai	\$737	\$803	\$1,270	\$1,319	\$1,658
Kia	\$202	\$431	\$558	\$839	\$1,168
Mazda	\$619	\$1,282	\$1,632	\$1,884	\$2,260
Mitsubishi	\$1,123	\$1,180	\$3,374	\$3,673	\$3,657
Nissan	\$531	\$1,029	\$2,272	\$2,286	\$2,479
Porsche	\$231	\$284	\$416	\$559	\$707
Subaru	\$375	\$493	\$1,993	\$2,516	\$2,568
Suzuki	\$220	\$1,532	\$2,389	\$2,504	\$2,636
Tata	\$213	\$272	\$477	\$704	\$1,449
Toyota	\$317	\$291	\$380	\$591	\$689
Volkswagen	\$248	\$588	\$749	\$910	\$1,312
Total/ Average	\$500	\$944	\$1,300	\$1,519	\$1,775

Table VII-2j
 Estimated Incremental Costs or Fines over Adjusted Baseline
 Total Incremental Costs in Millions (2007\$)
 Passenger Cars

**6% Annual Increase
 Total Incremental Costs**

Manufacturer	MY 2012	MY 2013	MY 2014	MY 2015	MY 2016
BMW	\$139	\$187	\$254	\$357	\$493
Chrysler	\$133	\$346	\$435	\$367	\$365
Daimler	\$26	\$46	\$176	\$267	\$367
Ford	\$2,101	\$3,308	\$3,318	\$3,904	\$4,328
General Motors	\$163	\$1,747	\$2,774	\$3,862	\$4,526
Honda	\$67	\$627	\$983	\$1,122	\$1,669
Hyundai	\$428	\$449	\$715	\$779	\$990
Kia	\$62	\$134	\$185	\$292	\$410
Mazda	\$194	\$408	\$553	\$641	\$781
Mitsubishi	\$73	\$72	\$191	\$192	\$196
Nissan	\$509	\$1,061	\$2,439	\$2,524	\$2,786
Porsche	\$7	\$10	\$16	\$20	\$26
Subaru	\$56	\$67	\$269	\$329	\$336
Suzuki	\$19	\$132	\$195	\$190	\$204
Tata	\$5	\$9	\$17	\$29	\$60
Toyota	\$537	\$541	\$753	\$1,249	\$1,483
Volkswagen	\$105	\$270	\$350	\$424	\$625
Total/ Average	\$4,623	\$9,415	\$13,623	\$16,548	\$19,646

Table VII-2k
 Estimated Incremental Costs or Fines over Adjusted Baseline
 Average Cost per Vehicle (2007\$)
 Passenger Cars

**7% Annual Increase
 Average Cost per Vehicle**

Manufacturer	MY 2012	MY 2013	MY 2014	MY 2015	MY 2016
BMW	\$507	\$612	\$777	\$1,043	\$1,399
Chrysler	\$759	\$1,906	\$2,531	\$2,717	\$2,764
Daimler	\$165	\$275	\$918	\$1,242	\$1,660
Ford	\$1,583	\$2,102	\$2,173	\$2,493	\$2,968
General Motors	\$127	\$1,051	\$1,679	\$2,303	\$2,655
Honda	\$126	\$736	\$998	\$1,039	\$1,504
Hyundai	\$737	\$813	\$1,871	\$1,946	\$2,284
Kia	\$261	\$632	\$898	\$1,278	\$1,579
Mazda	\$636	\$1,187	\$1,604	\$1,935	\$2,624
Mitsubishi	\$1,139	\$1,142	\$3,218	\$3,580	\$3,672
Nissan	\$683	\$1,090	\$2,120	\$2,158	\$2,437
Porsche	\$253	\$328	\$482	\$658	\$839
Subaru	\$392	\$531	\$2,031	\$2,739	\$2,854
Suzuki	\$242	\$1,508	\$2,015	\$2,245	\$2,639
Tata	\$229	\$305	\$532	\$781	\$1,548
Toyota	\$470	\$449	\$571	\$945	\$1,167
Volkswagen	\$264	\$627	\$809	\$998	\$1,427
Total/ Average	\$563	\$987	\$1,406	\$1,690	\$2,046

Table VII-21
 Estimated Incremental Costs or Fines over Adjusted Baseline
 Total Incremental Costs in Millions (2007\$)
 Passenger Cars

**7% Annual Increase
 Total Incremental Costs**

Manufacturer	MY 2012	MY 2013	MY 2014	MY 2015	MY 2016
BMW	\$144	\$198	\$274	\$388	\$533
Chrysler	\$136	\$334	\$428	\$371	\$383
Daimler	\$28	\$52	\$188	\$285	\$390
Ford	\$2,134	\$2,994	\$3,143	\$3,748	\$4,486
General Motors	\$188	\$1,702	\$2,868	\$4,121	\$4,833
Honda	\$145	\$995	\$1,490	\$1,624	\$2,395
Hyundai	\$428	\$455	\$1,053	\$1,149	\$1,363
Kia	\$79	\$196	\$297	\$444	\$554
Mazda	\$199	\$378	\$543	\$658	\$906
Mitsubishi	\$74	\$70	\$182	\$187	\$196
Nissan	\$655	\$1,124	\$2,275	\$2,383	\$2,738
Porsche	\$8	\$12	\$19	\$24	\$31
Subaru	\$58	\$72	\$274	\$358	\$374
Suzuki	\$21	\$130	\$164	\$171	\$204
Tata	\$5	\$10	\$19	\$32	\$64
Toyota	\$798	\$836	\$1,134	\$1,999	\$2,514
Volkswagen	\$112	\$287	\$379	\$464	\$680
Total/ Average	\$5,211	\$9,846	\$14,729	\$18,405	\$22,646

Table VII-2m
 Estimated Incremental Costs or Fines over Adjusted Baseline
 Average Cost per Vehicle (2007\$)
 Passenger Cars

Max Net Benefits
Average Cost per Vehicle

Manufacturer	MY 2012	MY 2013	MY 2014	MY 2015	MY 2016
BMW	\$513	\$640	\$788	\$993	\$1,283
Chrysler	\$759	\$1,868	\$2,495	\$2,595	\$2,540
Daimler	\$165	\$303	\$929	\$1,193	\$1,550
Ford	\$1,730	\$2,145	\$2,255	\$2,568	\$3,034
General Motors	\$132	\$1,078	\$1,690	\$2,253	\$2,476
Honda	\$58	\$559	\$763	\$795	\$1,013
Hyundai	\$739	\$843	\$1,361	\$1,411	\$1,613
Kia	\$261	\$545	\$783	\$987	\$1,166
Mazda	\$641	\$1,237	\$1,632	\$1,901	\$2,213
Mitsubishi	\$1,145	\$1,170	\$3,218	\$3,545	\$3,522
Nissan	\$683	\$1,118	\$2,120	\$2,133	\$2,318
Porsche	\$253	\$361	\$493	\$597	\$691
Subaru	\$397	\$564	\$2,042	\$2,560	\$2,590
Suzuki	\$242	\$1,541	\$2,015	\$2,184	\$2,491
Tata	\$235	\$327	\$538	\$731	\$1,438
Toyota	\$415	\$393	\$507	\$724	\$743
Volkswagen	\$270	\$654	\$815	\$943	\$1,295
Total/ Average	\$568	\$970	\$1,343	\$1,563	\$1,778

Table VII-2n
 Estimated Incremental Costs or Fines over Adjusted Baseline
 Total Incremental Costs in Millions (2007\$)
 Passenger Cars

Max Net Benefits
Total Incremental Costs

Manufacturer	MY 2012	MY 2013	MY 2014	MY 2015	MY 2016
BMW	\$145	\$207	\$277	\$369	\$489
Chrysler	\$136	\$327	\$422	\$354	\$352
Daimler	\$28	\$58	\$190	\$274	\$365
Ford	\$2,332	\$3,055	\$3,261	\$3,860	\$4,585
General Motors	\$196	\$1,747	\$2,887	\$4,033	\$4,507
Honda	\$67	\$756	\$1,139	\$1,242	\$1,614
Hyundai	\$429	\$471	\$766	\$833	\$963
Kia	\$79	\$169	\$259	\$343	\$409
Mazda	\$201	\$394	\$552	\$646	\$765
Mitsubishi	\$74	\$72	\$182	\$186	\$188
Nissan	\$655	\$1,153	\$2,275	\$2,356	\$2,605
Porsche	\$8	\$13	\$19	\$22	\$26
Subaru	\$59	\$77	\$276	\$334	\$339
Suzuki	\$21	\$133	\$164	\$166	\$193
Tata	\$5	\$11	\$19	\$30	\$60
Toyota	\$704	\$733	\$1,006	\$1,530	\$1,601
Volkswagen	\$114	\$300	\$381	\$439	\$617
Total/ Average	\$5,254	\$9,674	\$14,075	\$17,018	\$19,677

Table VII-2o
 Estimated Incremental Costs or Fines over Adjusted Baseline
 Average Cost per Vehicle (2007\$)
 Passenger Cars

Total Cost = Total Benefit
Average Cost per Vehicle

Manufacturer	MY 2012	MY 2013	MY 2014	MY 2015	MY 2016
BMW	\$535	\$678	\$837	\$1,059	\$1,371
Chrysler	\$786	\$1,930	\$2,544	\$2,624	\$2,656
Daimler	\$193	\$336	\$973	\$1,259	\$1,638
Ford	\$1,757	\$2,136	\$2,290	\$2,645	\$3,126
General Motors	\$154	\$1,117	\$1,734	\$2,325	\$2,633
Honda	\$76	\$805	\$1,065	\$1,116	\$1,559
Hyundai	\$794	\$925	\$1,731	\$1,791	\$2,030
Kia	\$319	\$609	\$997	\$1,256	\$1,446
Mazda	\$669	\$1,276	\$1,687	\$1,978	\$2,620
Mitsubishi	\$1,167	\$1,208	\$3,277	\$3,605	\$3,663
Nissan	\$664	\$1,074	\$2,072	\$2,149	\$2,405
Porsche	\$286	\$405	\$553	\$685	\$806
Subaru	\$425	\$603	\$2,097	\$2,761	\$2,827
Suzuki	\$275	\$1,585	\$2,076	\$2,267	\$2,606
Tata	\$257	\$365	\$587	\$803	\$1,526
Toyota	\$670	\$625	\$763	\$1,000	\$1,074
Volkswagen	\$297	\$693	\$870	\$1,020	\$1,400
Total/ Average	\$633	\$1,060	\$1,478	\$1,729	\$2,028

Table VII-2p
 Estimated Incremental Costs or Fines over Adjusted Baseline
 Total Incremental Costs in Millions (2007\$)
 Passenger Cars

Total Cost = Total Benefit
Total Incremental Costs

Manufacturer	MY 2012	MY 2013	MY 2014	MY 2015	MY 2016
BMW	\$152	\$219	\$295	\$394	\$522
Chrysler	\$140	\$338	\$430	\$358	\$368
Daimler	\$33	\$64	\$199	\$289	\$385
Ford	\$2,369	\$3,042	\$3,312	\$3,976	\$4,724
General Motors	\$229	\$1,809	\$2,962	\$4,161	\$4,793
Honda	\$88	\$1,089	\$1,590	\$1,744	\$2,484
Hyundai	\$461	\$517	\$974	\$1,058	\$1,212
Kia	\$97	\$188	\$330	\$437	\$508
Mazda	\$210	\$407	\$571	\$673	\$905
Mitsubishi	\$76	\$74	\$185	\$189	\$196
Nissan	\$636	\$1,108	\$2,224	\$2,373	\$2,703
Porsche	\$9	\$14	\$21	\$25	\$30
Subaru	\$63	\$82	\$283	\$361	\$370
Suzuki	\$24	\$137	\$169	\$172	\$202
Tata	\$6	\$12	\$21	\$33	\$63
Toyota	\$1,138	\$1,163	\$1,515	\$2,114	\$2,314
Volkswagen	\$126	\$318	\$407	\$475	\$667
Total/ Average	\$5,856	\$10,581	\$15,489	\$18,829	\$22,446

Table VII-3a
 Estimated Incremental Costs or Fines over Adjusted Baseline
 Average Cost per Vehicle (2007\$)
 Light Trucks

**Preferred Alternative
 Average Cost per Vehicle**

Manufacturer	MY 2012	MY 2013	MY 2014	MY 2015	MY 2016
BMW	\$325	\$327	\$380	\$708	\$884
Chrysler	\$152	\$399	\$749	\$892	\$1,188
Daimler	\$322	\$289	\$316	\$420	\$478
Ford	\$471	\$629	\$693	\$1,323	\$1,365
General Motors	\$33	\$533	\$752	\$792	\$962
Honda	\$390	\$380	\$616	\$749	\$1,006
Hyundai	\$774	\$744	\$1,301	\$1,322	\$1,292
Kia	\$228	\$373	\$547	\$843	\$1,218
Mazda	\$340	\$608	\$610	\$679	\$776
Mitsubishi	\$55	\$94	\$1,546	\$1,732	\$2,123
Nissan	\$541	\$608	\$903	\$1,022	\$1,312
Porsche	\$28	\$46	\$84	\$913	\$954
Subaru	\$1,203	\$1,140	\$1,213	\$1,197	\$1,184
Suzuki	\$50	\$1,451	\$1,404	\$1,358	\$1,373
Tata	\$44	\$83	\$127	\$193	\$635
Toyota	\$172	\$309	\$665	\$764	\$877
Volkswagen	\$28	\$61	\$99	\$160	\$231
Total/Average	\$291	\$485	\$701	\$911	\$1,058

Table VII-3b
 Estimated Incremental Costs or Fines over Adjusted Baseline
 Total Incremental Costs in Millions (2007\$)
 Light Trucks

**Preferred Alternative
 Total Incremental Costs**

Manufacturer	MY 2012	MY 2013	MY 2014	MY 2015	MY 2016
BMW	\$46	\$46	\$55	\$98	\$120
Chrysler	\$43	\$98	\$167	\$100	\$130
Daimler	\$35	\$33	\$40	\$48	\$53
Ford	\$483	\$696	\$834	\$1,628	\$1,641
General Motors	\$40	\$704	\$1,010	\$1,074	\$1,272
Honda	\$261	\$275	\$423	\$518	\$679
Hyundai	\$109	\$101	\$175	\$176	\$168
Kia	\$18	\$28	\$39	\$59	\$83
Mazda	\$24	\$43	\$41	\$40	\$45
Mitsubishi	\$1	\$1	\$14	\$13	\$15
Nissan	\$259	\$291	\$429	\$464	\$583
Porsche	\$1	\$1	\$2	\$15	\$16
Subaru	\$107	\$88	\$93	\$88	\$88
Suzuki	\$2	\$43	\$43	\$37	\$36
Tata	\$2	\$4	\$7	\$9	\$30
Toyota	\$175	\$314	\$695	\$826	\$928
Volkswagen	\$3	\$6	\$10	\$16	\$23
Total/ Average	\$1,608	\$2,774	\$4,075	\$5,211	\$5,911

Table VII-3c

Estimated Incremental Costs or Fines over Adjusted Baseline
Average Cost per Vehicle (2007\$)
Light Trucks

**3% Annual Increase
Average Cost per Vehicle**

Manufacturer	MY 2012	MY 2013	MY 2014	MY 2015	MY 2016
BMW	\$325	\$327	\$380	\$708	\$884
Chrysler	\$152	\$399	\$749	\$892	\$1,188
Daimler	\$322	\$289	\$316	\$420	\$478
Ford	\$471	\$629	\$693	\$1,323	\$1,365
General Motors	\$33	\$533	\$752	\$792	\$962
Honda	\$390	\$380	\$616	\$749	\$1,006
Hyundai	\$774	\$744	\$1,301	\$1,322	\$1,292
Kia	\$228	\$373	\$547	\$843	\$1,218
Mazda	\$340	\$608	\$610	\$679	\$776
Mitsubishi	\$55	\$94	\$1,546	\$1,732	\$2,123
Nissan	\$541	\$608	\$903	\$1,022	\$1,312
Porsche	\$28	\$46	\$84	\$913	\$954
Subaru	\$1,203	\$1,140	\$1,213	\$1,197	\$1,184
Suzuki	\$50	\$1,451	\$1,404	\$1,358	\$1,373
Tata	\$44	\$83	\$127	\$193	\$635
Toyota	\$172	\$309	\$665	\$764	\$877
Volkswagen	\$28	\$61	\$99	\$160	\$231
Total/ Average	\$291	\$485	\$701	\$911	\$1,058

Table VII-3d
 Estimated Incremental Costs or Fines over Adjusted Baseline
 Total Incremental Costs in Millions (2007\$)
 Light Trucks

**3% Annual Increase
 Total Incremental Costs**

Manufacturer	MY 2012	MY 2013	MY 2014	MY 2015	MY 2016
BMW	\$42	\$43	\$41	\$53	\$71
Chrysler	\$30	\$59	\$102	\$60	\$71
Daimler	\$17	\$15	\$16	\$38	\$41
Ford	\$156	\$241	\$358	\$941	\$917
General Motors	\$0	\$353	\$445	\$491	\$593
Honda	\$126	\$135	\$253	\$301	\$385
Hyundai	\$46	\$42	\$91	\$100	\$95
Kia	\$0	\$3	\$18	\$33	\$52
Mazda	\$14	\$17	\$18	\$18	\$18
Mitsubishi	\$0	\$0	\$5	\$4	\$6
Nissan	\$139	\$163	\$282	\$304	\$338
Porsche	\$0	\$0	\$0	\$14	\$14
Subaru	\$37	\$30	\$34	\$32	\$32
Suzuki	\$0	\$25	\$25	\$21	\$21
Tata	\$0	\$1	\$4	\$5	\$25
Toyota	\$25	\$32	\$215	\$334	\$521
Volkswagen	-\$2	\$0	\$5	\$9	\$13
Total/Average	\$629	\$1,159	\$1,911	\$2,760	\$3,213

Table VII-3e
 Estimated Incremental Costs or Fines over Adjusted Baseline
 Average Cost per Vehicle (2007\$)
 Light Trucks

**4% Annual Increase
 Average Cost per Vehicle**

Manufacturer	MY 2012	MY 2013	MY 2014	MY 2015	MY 2016
BMW	\$297	\$301	\$354	\$640	\$806
Chrysler	\$108	\$297	\$643	\$798	\$1,030
Daimler	\$152	\$153	\$173	\$399	\$446
Ford	\$477	\$660	\$818	\$1,376	\$1,368
General Motors	\$0	\$468	\$682	\$724	\$832
Honda	\$325	\$320	\$575	\$656	\$901
Hyundai	\$534	\$528	\$1,138	\$1,167	\$1,144
Kia	\$0	\$177	\$542	\$739	\$1,115
Mazda	\$295	\$488	\$496	\$529	\$728
Mitsubishi	\$6	\$55	\$864	\$1,046	\$1,438
Nissan	\$437	\$534	\$841	\$965	\$1,216
Porsche	-\$17	\$28	\$68	\$896	\$927
Subaru	\$1,398	\$1,370	\$1,427	\$1,416	\$1,405
Suzuki	\$0	\$1,229	\$1,179	\$1,137	\$1,283
Tata	\$0	\$44	\$110	\$176	\$607
Toyota	\$82	\$220	\$502	\$644	\$756
Volkswagen	-\$17	\$28	\$88	\$149	\$204
Total/ Average	\$236	\$430	\$659	\$859	\$975

Table VII-3f
 Estimated Incremental Costs or Fines over Adjusted Baseline
 Total Incremental Costs in Millions (2007\$)
 Light Trucks

**4% Annual Increase
 Total Incremental Costs**

Manufacturer	MY 2012	MY 2013	MY 2014	MY 2015	MY 2016
BMW	\$42	\$43	\$51	\$89	\$109
Chrysler	\$30	\$73	\$143	\$90	\$113
Daimler	\$17	\$18	\$22	\$45	\$49
Ford	\$489	\$730	\$984	\$1,694	\$1,645
General Motors	\$0	\$619	\$916	\$982	\$1,100
Honda	\$218	\$232	\$395	\$454	\$608
Hyundai	\$75	\$72	\$153	\$155	\$148
Kia	\$0	\$13	\$39	\$52	\$76
Mazda	\$21	\$35	\$33	\$31	\$42
Mitsubishi	\$0	\$1	\$8	\$8	\$10
Nissan	\$209	\$256	\$399	\$439	\$540
Porsche	\$0	\$1	\$1	\$15	\$16
Subaru	\$124	\$106	\$110	\$104	\$104
Suzuki	\$0	\$37	\$36	\$31	\$34
Tata	\$0	\$2	\$6	\$9	\$29
Toyota	\$83	\$224	\$525	\$697	\$800
Volkswagen	-\$2	\$3	\$9	\$15	\$20
Total/Average	\$1,307	\$2,462	\$3,830	\$4,909	\$5,445

Table VII-3g
 Estimated Incremental Costs or Fines over Adjusted Baseline
 Average Cost per Vehicle (2007\$)
 Light Trucks

**5% Annual Increase
 Average Cost per Vehicle**

Manufacturer	MY 2012	MY 2013	MY 2014	MY 2015	MY 2016
BMW	\$297	\$306	\$403	\$753	\$935
Chrysler	\$113	\$475	\$1,058	\$1,271	\$1,538
Daimler	\$172	\$198	\$227	\$459	\$528
Ford	\$732	\$1,201	\$1,685	\$2,345	\$2,380
General Motors	\$0	\$786	\$1,121	\$1,275	\$1,457
Honda	\$646	\$614	\$1,139	\$1,265	\$1,624
Hyundai	\$990	\$1,009	\$2,106	\$2,206	\$2,148
Kia	\$0	\$309	\$713	\$1,181	\$1,692
Mazda	\$434	\$608	\$612	\$722	\$953
Mitsubishi	\$11	\$88	\$2,102	\$2,081	\$2,817
Nissan	\$793	\$891	\$1,419	\$1,535	\$1,907
Porsche	-\$17	\$55	\$117	\$962	\$1,009
Subaru	\$1,398	\$1,370	\$1,501	\$1,441	\$1,486
Suzuki	\$6	\$2,169	\$2,093	\$2,028	\$2,155
Tata	\$0	\$77	\$160	\$242	\$695
Toyota	\$113	\$427	\$906	\$1,065	\$1,291
Volkswagen	-\$11	\$55	\$127	\$209	\$286
Total/ Average	\$373	\$742	\$1,179	\$1,449	\$1,641

Table VII-3h
 Estimated Incremental Costs or Fines over Adjusted Baseline
 Total Incremental Costs in Millions (2007\$)
 Light Trucks

**5% Annual Increase
 Total Incremental Costs**

Manufacturer	MY 2012	MY 2013	MY 2014	MY 2015	MY 2016
BMW	\$42	\$43	\$58	\$105	\$127
Chrysler	\$32	\$116	\$235	\$143	\$169
Daimler	\$19	\$23	\$28	\$52	\$58
Ford	\$751	\$1,330	\$2,025	\$2,886	\$2,862
General Motors	\$0	\$1,038	\$1,505	\$1,728	\$1,926
Honda	\$433	\$445	\$782	\$875	\$1,097
Hyundai	\$140	\$137	\$283	\$293	\$279
Kia	\$0	\$23	\$51	\$83	\$116
Mazda	\$31	\$43	\$41	\$43	\$55
Mitsubishi	\$0	\$1	\$19	\$15	\$20
Nissan	\$379	\$427	\$674	\$698	\$848
Porsche	\$0	\$1	\$2	\$16	\$17
Subaru	\$124	\$106	\$115	\$106	\$110
Suzuki	\$0	\$65	\$64	\$55	\$57
Tata	\$0	\$4	\$9	\$12	\$33
Toyota	\$115	\$435	\$948	\$1,152	\$1,366
Volkswagen	-\$1	\$6	\$13	\$21	\$29
Total/Average	\$2,065	\$4,243	\$6,854	\$8,283	\$9,168

Table VII-3i
 Estimated Incremental Costs or Fines over Adjusted Baseline
 Average Cost per Vehicle (2007\$)
 Light Trucks

**6% Annual Increase
 Average Cost per Vehicle**

Manufacturer	MY 2012	MY 2013	MY 2014	MY 2015	MY 2016
BMW	\$297	\$325	\$447	\$819	\$1,023
Chrysler	\$124	\$835	\$1,753	\$2,118	\$2,367
Daimler	\$240	\$248	\$332	\$520	\$611
Ford	\$732	\$1,267	\$1,507	\$2,940	\$2,930
General Motors	\$11	\$1,397	\$1,753	\$1,959	\$2,156
Honda	\$991	\$917	\$1,806	\$1,924	\$2,360
Hyundai	\$1,632	\$1,656	\$3,342	\$3,441	\$3,179
Kia	\$89	\$668	\$1,346	\$1,915	\$2,478
Mazda	\$552	\$1,043	\$1,054	\$1,264	\$1,468
Mitsubishi	\$28	\$116	\$1,913	\$2,158	\$3,165
Nissan	\$925	\$1,069	\$2,633	\$2,761	\$2,902
Porsche	\$0	\$62	\$161	\$1,023	\$1,097
Subaru	\$1,398	\$1,342	\$1,545	\$1,554	\$1,608
Suzuki	\$17	\$2,395	\$2,264	\$2,203	\$2,782
Tata	\$17	\$105	\$209	\$314	\$789
Toyota	\$136	\$467	\$1,161	\$1,371	\$1,659
Volkswagen	\$0	\$83	\$176	\$270	\$369
Total/ Average	\$455	\$1,000	\$1,587	\$2,041	\$2,229

Table VII-3j
 Estimated Incremental Costs or Fines over Adjusted Baseline
 Total Incremental Costs in Millions (2007\$)
 Light Trucks

**6% Annual Increase
 Total Incremental Costs**

Manufacturer	MY 2012	MY 2013	MY 2014	MY 2015	MY 2016
BMW	\$42	\$46	\$64	\$114	\$139
Chrysler	\$35	\$204	\$390	\$238	\$260
Daimler	\$26	\$29	\$42	\$59	\$68
Ford	\$751	\$1,404	\$1,811	\$3,619	\$3,523
General Motors	\$13	\$1,845	\$2,355	\$2,656	\$2,851
Honda	\$664	\$664	\$1,241	\$1,331	\$1,594
Hyundai	\$230	\$225	\$449	\$458	\$412
Kia	\$7	\$50	\$97	\$134	\$169
Mazda	\$40	\$74	\$71	\$75	\$85
Mitsubishi	\$0	\$1	\$17	\$16	\$23
Nissan	\$442	\$511	\$1,249	\$1,255	\$1,290
Porsche	\$0	\$1	\$3	\$17	\$19
Subaru	\$124	\$104	\$119	\$114	\$119
Suzuki	\$1	\$71	\$69	\$60	\$74
Tata	\$1	\$5	\$11	\$15	\$37
Toyota	\$138	\$476	\$1,214	\$1,482	\$1,754
Volkswagen	\$0	\$8	\$18	\$28	\$37
Total/ Average	\$2,515	\$5,719	\$9,221	\$11,670	\$12,454

Table VII-3k
 Estimated Incremental Costs or Fines over Adjusted Baseline
 Average Cost per Vehicle (2007\$)
 Light Trucks

**7% Annual Increase
 Average Cost per Vehicle**

Manufacturer	MY 2012	MY 2013	MY 2014	MY 2015	MY 2016
BMW	\$301	\$345	\$484	\$890	\$1,116
Chrysler	\$141	\$1,541	\$2,352	\$2,407	\$3,287
Daimler	\$307	\$329	\$421	\$586	\$699
Ford	\$1,095	\$1,619	\$1,705	\$3,305	\$3,427
General Motors	\$22	\$1,801	\$2,357	\$2,591	\$2,865
Honda	\$1,007	\$945	\$2,099	\$2,239	\$2,799
Hyundai	\$1,710	\$1,727	\$2,622	\$2,681	\$2,748
Kia	\$123	\$1,058	\$1,320	\$1,908	\$2,667
Mazda	\$1,452	\$2,102	\$2,085	\$2,188	\$2,528
Mitsubishi	\$39	\$149	\$1,854	\$2,038	\$3,467
Nissan	\$923	\$1,067	\$2,484	\$2,559	\$2,963
Porsche	\$11	\$95	\$211	\$1,094	\$1,185
Subaru	\$1,361	\$1,302	\$1,634	\$1,665	\$1,781
Suzuki	\$33	\$3,866	\$3,270	\$3,199	\$3,792
Tata	\$33	\$138	\$264	\$391	\$888
Toyota	\$193	\$554	\$1,484	\$1,761	\$2,166
Volkswagen	\$11	\$110	\$220	\$336	\$457
Total/ Average	\$553	\$1,240	\$1,877	\$2,374	\$2,693

Table VII-31
 Estimated Incremental Costs or Fines over Adjusted Baseline
 Total Incremental Costs in Millions (2007\$)
 Light Trucks

**7% Annual Increase
 Total Incremental Costs**

Manufacturer	MY 2012	MY 2013	MY 2014	MY 2015	MY 2016
BMW	\$43	\$49	\$70	\$124	\$151
Chrysler	\$40	\$377	\$523	\$270	\$361
Daimler	\$34	\$38	\$53	\$66	\$77
Ford	\$1,123	\$1,793	\$2,050	\$4,068	\$4,121
General Motors	\$27	\$2,378	\$3,165	\$3,513	\$3,788
Honda	\$674	\$685	\$1,442	\$1,549	\$1,890
Hyundai	\$241	\$234	\$352	\$357	\$357
Kia	\$10	\$79	\$95	\$133	\$182
Mazda	\$104	\$150	\$139	\$130	\$147
Mitsubishi	\$0	\$2	\$17	\$15	\$25
Nissan	\$441	\$510	\$1,179	\$1,163	\$1,317
Porsche	\$0	\$2	\$4	\$18	\$20
Subaru	\$121	\$101	\$126	\$122	\$132
Suzuki	\$1	\$115	\$100	\$87	\$101
Tata	\$1	\$6	\$14	\$19	\$42
Toyota	\$197	\$564	\$1,552	\$1,904	\$2,291
Volkswagen	\$1	\$11	\$23	\$34	\$46
Total/ Average	\$3,058	\$7,095	\$10,905	\$13,574	\$15,047

Table VII-3m
 Estimated Incremental Costs or Fines over Adjusted Baseline
 Average Cost per Vehicle (2007\$)
 Light Trucks

Max Net Benefits
Average Cost per Vehicle

Manufacturer	MY 2012	MY 2013	MY 2014	MY 2015	MY 2016
BMW	\$681	\$751	\$850	\$967	\$1,100
Chrysler	\$223	\$1,382	\$1,974	\$2,471	\$2,719
Daimler	\$424	\$442	\$494	\$611	\$641
Ford	\$1,420	\$1,565	\$1,560	\$2,617	\$2,582
General Motors	\$99	\$1,514	\$1,882	\$2,081	\$2,138
Honda	\$1,262	\$1,191	\$2,274	\$2,337	\$2,480
Hyundai	\$1,922	\$1,822	\$2,877	\$2,930	\$2,864
Kia	\$470	\$1,028	\$1,347	\$1,897	\$2,472
Mazda	\$708	\$1,202	\$1,206	\$1,330	\$1,401
Mitsubishi	\$143	\$231	\$1,810	\$2,038	\$3,165
Nissan	\$1,236	\$1,366	\$2,655	\$2,713	\$3,032
Porsche	\$105	\$167	\$244	\$1,089	\$1,097
Subaru	\$1,609	\$1,514	\$1,682	\$1,710	\$1,717
Suzuki	\$132	\$2,406	\$2,336	\$2,265	\$2,311
Tata	\$132	\$215	\$297	\$385	\$789
Toyota	\$604	\$1,629	\$2,097	\$2,299	\$2,445
Volkswagen	\$105	\$182	\$253	\$330	\$369
Total/ Average	\$789	\$1,405	\$1,871	\$2,227	\$2,324

Table VII-3n
 Estimated Incremental Costs or Fines over Adjusted Baseline
 Total Incremental Costs in Millions (2007\$)
 Light Trucks

Max Net Benefits
Total Incremental Costs

Manufacturer	MY 2012	MY 2013	MY 2014	MY 2015	MY 2016
BMW	\$97	\$107	\$122	\$134	\$149
Chrysler	\$63	\$338	\$439	\$278	\$298
Daimler	\$46	\$51	\$62	\$69	\$71
Ford	\$1,456	\$1,733	\$1,875	\$3,221	\$3,105
General Motors	\$120	\$1,999	\$2,528	\$2,822	\$2,828
Honda	\$845	\$863	\$1,563	\$1,616	\$1,675
Hyundai	\$271	\$247	\$386	\$390	\$372
Kia	\$37	\$77	\$97	\$133	\$169
Mazda	\$51	\$85	\$81	\$79	\$81
Mitsubishi	\$1	\$3	\$17	\$15	\$23
Nissan	\$591	\$654	\$1,260	\$1,233	\$1,347
Porsche	\$2	\$3	\$5	\$18	\$19
Subaru	\$143	\$117	\$129	\$126	\$127
Suzuki	\$4	\$72	\$71	\$62	\$61
Tata	\$6	\$10	\$16	\$19	\$37
Toyota	\$616	\$1,660	\$2,193	\$2,486	\$2,587
Volkswagen	\$11	\$18	\$26	\$34	\$37
Total/ Average	\$4,361	\$8,038	\$10,870	\$12,734	\$12,986

Table VII-3o
 Estimated Incremental Costs or Fines over Adjusted Baseline
 Average Cost per Vehicle (2007\$)
 Light Trucks

Total Cost = Total Benefit
Average Cost per Vehicle

Manufacturer	MY 2012	MY 2013	MY 2014	MY 2015	MY 2016
BMW	\$728	\$810	\$912	\$1,035	\$1,167
Chrysler	\$245	\$1,398	\$2,053	\$2,520	\$3,037
Daimler	\$441	\$458	\$516	\$660	\$690
Ford	\$1,436	\$1,581	\$1,630	\$2,904	\$2,930
General Motors	\$116	\$1,787	\$2,432	\$2,650	\$2,723
Honda	\$1,316	\$1,256	\$2,332	\$2,402	\$2,766
Hyundai	\$2,015	\$1,908	\$3,018	\$2,962	\$2,934
Kia	\$492	\$1,050	\$1,369	\$1,946	\$2,661
Mazda	\$1,188	\$1,884	\$1,869	\$1,940	\$2,000
Mitsubishi	\$165	\$253	\$1,920	\$2,093	\$3,423
Nissan	\$1,186	\$1,324	\$2,739	\$2,709	\$3,029
Porsche	\$127	\$183	\$266	\$1,138	\$1,147
Subaru	\$1,663	\$1,567	\$1,811	\$1,864	\$1,881
Suzuki	\$154	\$3,574	\$3,270	\$3,199	\$3,247
Tata	\$154	\$237	\$325	\$440	\$844
Toyota	\$626	\$1,645	\$2,232	\$2,465	\$2,623
Volkswagen	\$121	\$198	\$275	\$380	\$418
Total/ Average	\$815	\$1,500	\$2,074	\$2,482	\$2,633

Table VII-3p
 Estimated Incremental Costs or Fines over Adjusted Baseline
 Total Incremental Costs in Millions (2007\$)
 Light Trucks

Total Cost = Total Benefit
Total Incremental Costs

Manufacturer	MY 2012	MY 2013	MY 2014	MY 2015	MY 2016
BMW	\$104	\$115	\$131	\$144	\$158
Chrysler	\$69	\$342	\$457	\$283	\$333
Daimler	\$48	\$53	\$65	\$75	\$76
Ford	\$1,473	\$1,752	\$1,959	\$3,575	\$3,523
General Motors	\$140	\$2,359	\$3,266	\$3,592	\$3,601
Honda	\$881	\$910	\$1,602	\$1,662	\$1,868
Hyundai	\$284	\$259	\$405	\$394	\$381
Kia	\$39	\$78	\$99	\$136	\$182
Mazda	\$85	\$134	\$125	\$115	\$116
Mitsubishi	\$2	\$3	\$18	\$15	\$25
Nissan	\$567	\$633	\$1,300	\$1,231	\$1,346
Porsche	\$3	\$4	\$5	\$19	\$20
Subaru	\$148	\$122	\$139	\$137	\$139
Suzuki	\$5	\$106	\$100	\$87	\$86
Tata	\$6	\$11	\$17	\$21	\$40
Toyota	\$638	\$1,677	\$2,334	\$2,665	\$2,775
Volkswagen	\$13	\$20	\$29	\$39	\$42
Total/ Average	\$4,505	\$8,578	\$12,052	\$14,191	\$14,711

Technology Costs

Table V-5 provides the technology cost estimates used in this analysis. The technology cost estimates are intended to represent manufacturers' direct costs for high-volume production of vehicles with these technologies and sufficient experience with their application so that all cost reductions due to "learning curve" effects have been fully realized. Costs are then modified by applying indirect cost multipliers ranging from 1.05 to 1.46 to the estimates of vehicle manufacturers' direct costs for producing or acquiring each technology to improve fuel economy, depending on the complexity of the technology and the time frame over which costs are estimated.

Potential opportunity costs of improved fuel economy

An important concern is whether achieving the fuel economy improvements required by alternative CAFE standards would require manufacturers to compromise the performance, carrying capacity, safety, or comfort of their vehicles. If it did so, the resulting sacrifice in the value of these attributes to vehicle buyers would represent an additional cost of achieving the required improvements in fuel economy, and thus of manufacturers' compliance with stricter CAFE standards. While exact dollar values of these attributes to buyers are extremely difficult to infer from vehicle purchase prices, it is nevertheless clear that changes in these attributes can affect the utility that vehicles provide to their owners, and thus their value to potential buyers.

The agency has approached this potential problem by developing cost estimates for fuel economy-improving technologies that include any additional manufacturing costs that would be necessary to maintain the performance, comfort, capacity, or safety of any vehicle to which those technologies are applied. Theoretically, opportunity costs could also include any foregone opportunities to enhance these products for consumers. However, estimating values for foregone opportunities is an even tougher task. So, the agency followed the precedent established by the National Academy of Sciences (NAS) in its 2002 analysis of the costs and benefits of improving fuel economy by raising CAFE standards.¹⁶⁴ The NAS study estimated "constant performance and utility" costs for fuel economy technologies, and the agency has used these as the basis for developing the technology costs it employed in analyzing manufacturer's costs for complying with alternative standards.

NHTSA fully acknowledges the difficulty of estimating technology costs that include costs for the accompanying changes in vehicle design that are necessary to maintain performance, capacity, and utility. However, the agency believes its cost estimates for fuel economy technologies are generally sufficient to prevent significant reductions in consumer welfare.

Financial Impacts of Raising CAFE Standards

The national and global economies are in crisis. Even before recent developments, the automobile manufacturers were already facing substantial difficulties. Together, these problems have made NHTSA's economic practicability analysis particularly important and challenging in this rulemaking.

¹⁶⁴ National Academy of Sciences, *Costs and Effectiveness of Increasing Corporate Average Fuel Economy Standards*, 2002.

Automobile sales have dropped significantly. U.S. motor vehicle sales in 2008 were 18 percent below 2007 levels. January-June 2009 industry sales were 35 percent lower than in the first half of 2008.¹⁶⁵ The sales of every major manufacturer declined. Vehicle manufacturers have not been able to raise prices to offset declining unit sales.¹⁶⁶

The financial state of the major U.S. automotive manufacturers is particularly difficult. In recent months, both General Motors and Chrysler have reorganized in bankruptcy proceedings, and have been recapitalized, largely with public monies, leaving the United States Government as a substantial shareholder in both companies. The Treasury has made available some \$30.1 billion to GM and \$4.7 billion to Chrysler, buttressed by an additional \$9.5 billion from the Canadian Government and Ontario Provincial Government.¹⁶⁷

Clearly, GM and Chrysler were not economically viable prior to their bankruptcies. The future viability of the reorganized firms will be demonstrated over the next few quarters. General Motors' year-to-date 2009 U.S. vehicle sales were down 40 percent, while Chrysler's year-to-date sales are off 46 percent.¹⁶⁸ However, both GM and Chrysler were able to achieve these shrunken sales figures only by offering significant financial inducements to buyers. According to the research firm Edmunds, Chrysler paid out average incentives of more than \$4,500 for each light duty vehicle sold (18 percent of sticker price), while GM and Ford offered incentives of about \$3,500 per vehicle (16-17 percent of sticker price).¹⁶⁹

On the other hand, both firms have been able to drastically shrink their debt, sell or close unprofitable subsidiaries, while shedding capacity and costs. For both firms, there will be a new balance between capacity, costs, and sales which will gradually become more apparent with the passage of time.

Although Ford Motor Company did not declare bankruptcy, the firm has been able to negotiate substantial concessions from creditors, and also to raise new equity. Ford's 2008 sales declined 20 percent, and year-to-date sales are down 32 percent.¹⁷⁰ As in the case with GM and Chrysler, restructuring will shift the balance between costs and revenues, so it would be reasonable to expect the firm's losses to narrow considerably over the next few quarters.

¹⁶⁵ Ward's Automotive, "Ward's U.S. Light Vehicle Sales Summary," June 2009. Available at: <http://wardsauto.com/keydata/USSalesSummary0906.xls> / (Last accessed July 21, 2009).

¹⁶⁶ Commerce Department data indicates no apparent change in nominal prices of new vehicle sales over the past few years.

¹⁶⁷ US Department of the Treasury, FACT SHEET: Obama Administration Auto Restructuring initiative: General Motors Restructuring. Available at: <http://www.treas.gov/press/releases/tg179.htm> ((last accessed July 21, 2009).

¹⁶⁸ Ward's Automotive, "Ward's U.S. Light Vehicle Sales Summary," June 2009. Available at: <http://wardsauto.com/keydata/USSalesSummary0906.xls> / (Last accessed July 21, 2009).

¹⁶⁹ "June is Priciest Ever for Automaker Incentives, Edmunds.com Reports," Edmunds Auto Observer, June 21 2009. Available at: <http://www.autoobserver.com/2009/07/june-is-priciest-ever-for-automaker-incentives-edmundscom-reports.html> (last accessed July 21, 2009).

¹⁷⁰ Ford Motor Company, Fourth quarter 2008 financial results. Available at: <http://www.ford.com/about-ford/investor-relations/company-reports/financial-results> (last accessed February 6, 2009).

The automobile industry is already experiencing substantial economic hardship, even in the absence of new fuel economy standards. All three firms have announced a steady stream of plant closings, layoffs, and employment of new employees at reduced wages. NHTSA believes these hardships have much to do with the condition of the national economy and perhaps the price of gasoline, and little, if anything, to do with the stringency of CAFE standards for the current or recent model years. We believe that given the scale of the recent decline in industry sales, and the restrictiveness of private credit markets, that near-term developments will be compelled by the industry's immediate financial situation, rather than by the long-term financial consequences of this rulemaking.

Market forces are already requiring manufacturers to improve the fuel economy of their vehicles, as shown both by changes in product plans reported to NHTSA, and by automaker announcements in recent weeks. The improvements in fleet fuel economy required by this rule are consistent with the pressure induced by changing consumer preferences.

The various compliance flexibility mechanisms permitted by EISA, including flexible and alternative fuel vehicles, banking, averaging, and trading of fuel economy credits will also reduce compliance costs to some degree. By statute, NHTSA is not permitted to consider the benefits of flexibility mechanisms in setting fuel economy standards.

On May 19, President Obama announced a National Fuel Efficiency Policy.¹⁷¹ This policy reflected a consensus among stakeholders (including 14 automobile companies) on desirable and achievable fuel economy standards. We believe that this consensus reflects the view of the industry, that given current economic conditions, and in the light of Federal assistance proffered via various means, that the standards proposed here at economically practicable.

On the other hand, the agency is mindful that CAFE standards do affect the relative competitiveness of different vehicle manufacturers, and recognizes that standards more stringent than those promulgated here could have a more detrimental effect.

NHTSA central problem is to determine what new standards might be economically practicable within the MY 2012-2016 time frame, given the state of both the domestic and the international auto industries. The complexity of an economic practicability determination has been materially increased by the substantial financial assistance provided to the automobile industry by the U.S. Government. In addition to the large sums provided to Chrysler and GM, Congress has appropriated \$7.5 billion (to support a maximum of \$25 billion in loans under Section 136 of EISA to support the development of advanced technology vehicles and components in the United States.¹⁷² On June 23, the Department of Energy announced the first three loans under this

¹⁷¹ The White House, "President Obama Announces National Fuel Efficiency Policy," May 19, 2009. Available at: http://www.whitehouse.gov/the_press_office/President-Obama-Announces-National-Fuel-Efficiency-Policy/. (last accessed: July 21, 2009).

¹⁷²¹⁷² The authorizing language for this provision is in Section 136 of EISA. This language is amended and funds are appropriated in the Emergency Economic Stabilization Act of 2008 (H.R. 1424, Pub.L. 110-343). *See also* the DOE Advanced Technology Vehicle Manufacturing Loan Program website: <http://www.atvmloan.energy.gov/> (last accessed February 6, 2009).

program: \$5.9 billion for Ford for advanced vehicle manufacturing, \$1.3 billion for Nissan for vehicle and battery manufacturing, and \$0.5 billion for electric vehicle start-up Tesla Motors.¹⁷³

Given the foregoing, therefore, the agency has decided that in this exceptional situation, economic practicability must be determined based on whether the expenditures needed to achieve compliance with the final MY 2012-2016 standards are “within the financial capability of the industry, but not so stringent as to threaten substantial economic hardship for the industry,” no matter who contributes the funds. We have set the proposed MY 2012-2016 CAFE standards so that they are both technologically and economically feasible. In principle, most vehicles meeting the standard will provide social benefits to the public at large and private benefits to automobile owners greater than their extra cost.

One of the primary ways in which the agency seeks to ensure that its standards are within the financial capability of the industry is to attempt to ensure that manufacturers have sufficient lead time to modify their manufacturing plans to comply with the final standards in the model years covered by them. Employing appropriate assumptions about lead time in our analysis helps to avoid applying technologies before they are ready to be applied, or when their benefits are insufficient to justify their costs. It also helps avoid basing standards on the assumption that technologies could be applied more rapidly than practically achievable by manufacturers. NHTSA considers these matters in its analysis of issues including refresh and redesign schedules, phase-in caps, and learning rates.

NHTSA further considers the sales and employment impacts of the final standards on individual manufacturers as part of its efforts to determine whether the standards are economically practicable. The sales analysis looks at a purchasing decision from the eyes of a knowledgeable and rational consumer, comparing the estimated cost increase versus the payback in fuel savings over 5 years (the average new vehicle loan) for each manufacturer. This relationship depends on the cost-effectiveness of technologies available to each manufacturer based on a 3 percent discount rate for future fuel savings.

The agency does not have the capability to predict the capital investment needs of the automobile industry to install fuel economy technologies, nor the capability to determine the level of capital investments available to specific manufacturers in the future. The agency asks for comments to provide us with information about the ability of manufacturers to provide the capital investment needs for the various alternatives.

The Impact of Higher Prices on Sales and Employment

Higher fuel economy standards are expected to increase the price of passenger cars and light trucks. The potential impact of higher vehicle prices on sales was examined on an industry wide basis for passenger cars and light trucks separately. The analysis conducted for this rule does not have the precision to examine effects on individual manufacturers or different vehicle classes.

¹⁷³ US Department of Energy, “Obama Administration Awards First Three Auto Loans for Advanced Technologies to Ford Motor Company, Nissan Motors and Tesla Motors,” June 23, 2009. Available at: <http://www.atvmloan.energy.gov/>. Last accessed: July 21, 2009. ...

There is a broad consensus in the economic literature that the price elasticity for demand for automobiles is approximately -1.0 .^{174,175,176} Thus, every one percent increase in the price of the vehicle would reduce sales by one percent. Elasticity estimates assume no perceived change in the quality of the product. However, in this case, vehicle price increases result from adding technologies that improve fuel economy. If consumers do not value improved fuel economy at all, and consider nothing but the increase in price in their purchase decisions, then the estimated impact on sales from price elasticity could be applied directly. However, we believe that consumers do value improved fuel economy, because they reduce the operating cost of the vehicles. We also believe that consumers consider other factors that affect their costs and have included these in the analysis.

One issue that significantly affects this sales analysis is: How much of the retail price increase needed to cover the fuel economy technology investments will manufacturers be able to pass on to consumers? The estimates reported below assume that manufacturers will be able to pass all of their costs to improve fuel economy on to consumers. However, the ability of manufacturers to pass the compliance costs on to consumers will depend upon how consumers value the fuel economy improvements¹⁷⁷. Consumer valuation of fuel economy improvements often depends upon the price of gasoline, which has recently been very volatile. To the extent that we have accurately predicted the price of gasoline and consumers reactions, and manufacturers can pass on all of the costs to consumers, then the sales and employment impact analyses are reasonable. If manufacturers only increase retail prices to the extent that consumers value these fuel economy improvements, then there would be no impact on sales.

Sales losses are predicted to occur only if consumers fail to value fuel economy improvements at least as much as they pay in higher prices. If manufacturers are unable to raise prices beyond the level of consumer's valuation of fuel savings, then manufacturer's profit levels would fall but there would be no impact on sales. Likewise, if fuel prices rise beyond levels used in this analysis, consumer's valuation of improved fuel economy could increase to match or exceed their initial investment, resulting in no impact or even an increase in sales levels.

To estimate the average value consumers place on fuel savings at the time of purchase, we assume that the average purchaser considers the fuel savings they would receive over a 5 year timeframe. We chose 5 years because this is the average length of time of a financing agreement.¹⁷⁸ The present values of these savings were calculated using a 3 percent discount rate. We used a fuel price forecast (see Table VIII-3) that included taxes, because this is what

¹⁷⁴ Kleit, A.N. (1990). "The Effect of Annual Changes in Automobile Fuel Economy Standards," *Journal of Regulatory Economics*, vol. 2, pp 151-172.

¹⁷⁵ Bordley, R. (1994). "An Overlapping Choice Set Model of Automotive Price Elasticities," *Transportation Research B*, vol 28B, no 6, pp 401-408.

¹⁷⁶ McCarthy, P.S. (1996). "Market Price and Income Elasticities of New Vehicle Demands," *The Review of Economics and Statistics*, vol. LXXVII, no. 3, pp. 543-547.

¹⁷⁷ Gron, Ann and Swenson, Deborah, 2000, "Cost Pass-Through in the U.S. Automobile Market", *The Review of Economics and Statistics*, 82: 316-324.

¹⁷⁸ National average financing terms for automobile loans are available from the Board of Governors of the Federal Reserve System G.19 "Consumer Finance" release. See: <http://www.federalreserve.gov/releases/g19/>

consumers must pay. Fuel savings were calculated over the first 5 years and discounted back to a present value.

The agency believes that consumers may consider several other factors over the 5 year horizon when contemplating the purchase of a new vehicle. The agency added these factors into the calculation to represent how an increase in technology costs might affect consumers' buying considerations.

First, consumers might consider the sales taxes they have to pay at the time of purchasing the vehicle. We took sales taxes in 2007 by state and weighted them by population by state to determine a national weighted-average sales tax of 5.5 percent.

Second, we considered insurance costs over the 5 year period. More expensive vehicles will require more expensive collision and comprehensive (e.g., theft) car insurance. The increase in insurance costs is estimated from the average value of collision plus comprehensive insurance as a proportion of average new vehicle price. Collision plus comprehensive insurance is the portion of insurance costs that depend on vehicle value. The Insurance Information Institute¹⁷⁹ provides the average value of collision plus comprehensive insurance in 2006 as \$448. The average value of a new passenger car in 2006, according to the U.S. Department of Energy, was \$22,651.¹⁸⁰ Using sales volumes from Ward's Automotive Yearbook 2008 for MY 2007 sales and the MY 2008 base vehicle average prices, we determined an average passenger car and an average light truck price. The average base price for all passenger cars using this method was \$26,201 and for all light trucks was \$29,678 (\$2007 dollars). While this method does not give an exact price, the ratio of light truck prices to passenger car prices was applied and on-road registrations for passenger cars and light trucks for 2006 were applied to get an overall new light vehicle price¹⁸¹. The result is an average price for light vehicles of \$24,033¹⁸² for 2006. Average prices and estimated sales volumes are needed because price elasticity is an estimate of how a percent increase in price affects the percent decrease in sales.

Dividing the insurance cost by the average price of a new vehicle gives the proportion of comprehensive plus collision insurance as 1.86% of the price of a vehicle. If we assume that this premium is proportional to the new vehicle price, it represents about 1.86 percent of the new vehicle price and insurance is paid each year for the five year period we are considering for payback. Discounting that stream of insurance costs back to present value indicates that the present value of the component of insurance costs that vary with vehicle price is equal to 8.5 percent of the vehicle's price at a 3 percent discount rate.

¹⁷⁹ Insurance Information Institute, 2008, "Average Expenditures for Auto Insurance By State, 2005-2006," <http://www.iii.org/media/facts/statsbyissue/auto/>, accessed April 23, 2009.

¹⁸⁰ U.S. Department of Energy, 2008, "Average Price of a New Car, 1970-2006," http://www1.eere.energy.gov/vehiclesandfuels/facts/2008_fotw520.html, accessed April 23, 2009.

¹⁸¹ The base price does not include the more expensive lines of a model or purchased optional equipment; nor does it count discounts given. Thus, it is not an average light truck purchase transaction price, but a price that we can track.

¹⁸² $\$29,678/\$26,201 = 1.1327 * \$22,651 = \$25,657$ average price for light trucks. In 2006, passenger cars were 54% of the on road fleet and light trucks were 46% of the on road fleet, resulting in an average light vehicle price for 2006 of \$24,033.

Third, we considered that 70 percent of new vehicle purchasers take out loans to finance their purchase. The average new vehicle loan is for 5 years at a 6 percent rate¹⁸³. At these terms the average person taking a loan will pay 16 percent more for their vehicle over the 5 years than a consumer paying cash for the vehicle at the time of purchase¹⁸⁴. Discounting the additional 3.2 percent (16 percent / 5 years) per year over the 5 years using a 3 percent mid-year discount rate¹⁸⁵ results in a discounted present value of 14.87 percent higher for those taking a loan. Multiplying that by the 70 percent that take a loan, means that the average consumer would pay 10.2 percent more than the retail price for loans the consumer discounted at a 3 percent discount rate.

Fourth, we considered the residual value (or resale value) of the vehicle after 5 years and expressed this as a percentage of the new vehicle price. In other words, if the price of the vehicle increases due to fuel economy technologies, the resale value of the vehicle will go up proportionately. The average resale price of a vehicle after 5 years is about 35%¹⁸⁶ of the original purchase price. Discounting the residual value back 5 years using a 3 percent discount rate (35 percent * .8755) gives an effective residual value at new of 30.6 percent.

We add these four factors together. At a 3 percent discount rate, the consumer considers he could get 30.6 percent back upon resale in 5 years, but will pay 5.5 percent more for taxes, 8.5 percent more in insurance, and 10.2 percent more for loans, results in a 6.48 percent return on the increase in price for fuel economy technology (30.6 percent – 5.5 percent - 8.5 percent – 10.2 percent). Thus, the increase in price per vehicle is multiplied by 0.9352 (1 – 0.0648) before subtracting the fuel savings to determine the overall net consumer valuation of the increase of costs on his purchase decision.

A sample calculation for passenger cars under the Preferred alternative at a 3 percent discount rate in MY 2012 is an estimated retail price increase of \$498 which is multiplied by 0.9352 to get a residual price increase of \$466. The estimated fuel savings over the 5 years of \$284 at a 3 percent discount rate results in a net cost to consumers of \$182. Comparing that to the \$22,651 average price of a passenger car is a 0.8 percent price increase. Passenger car sales were estimated to be about 9,256,000 passenger cars for MY 2012. With a price elasticity of –1.0, a 0.8 percent increase in net cost to consumers could result in an estimated loss in sales of 74,443 passenger cars.

Table VII-6a, b, and c show the estimated impact on sales for passenger cars, light trucks, and combined, respectively. Combined passenger car and light truck sales increases reach their height at about the 4 percent per year alternative. As the alternatives get stricter after 5 percent per year, there are progressively larger losses in sales. Remember that the preferred alternative is

¹⁸³ New car loan rates in 2007 average about 7.8 percent at commercial banks and 4.5 percent at auto finance companies, so their average is close to 7 percent

¹⁸⁴ Based on www.bankrate.com auto loan calculator for a 5 year loan at 6 percent.

¹⁸⁵ For a 3 percent discount rate, the summation of 3.2 percent x 0.9853 in year one, 3.2 x 0.9566 in year two, 3.2 x 0.9288 in year three, 3.2 x 0.9017 in year 4, and 3.2 x 0.8755 in year five.

¹⁸⁶ ¹⁸⁶ Consumer Reports, August 2008, “What That Car Really Costs to Own,” <http://www.consumerreports.org/cro/cars/pricing/what-that-car-really-costs-to-own-4-08/overview/what-that-car-really-costs-to-own-ov.htm> , accessed April 23, 2009.

between the 4 percent and 5 percent annual increase alternatives in terms of mpg strictness and the maximum net benefit is between the 6 and 7 percent annual increase alternatives.

Note that there is no feedback loop between this sales analysis and the Volpe model. These sales estimates are not used to determine additional or less mileage traveled or fuel consumed. The Volpe model does not attempt to estimate the extent to which the sales volumes of different vehicle models might change in response to fuel economy increases, financial outlays for additional technology, and increases in civil penalties that could all result from increased CAFE standards.

There are studies that estimate that people may hold onto their vehicles longer as a result of an increase in price, everything else being held equal. This analysis estimates that consumers will purchase more vehicles because of their improved fuel economy. In general, changes in prices or other characteristics of the new vehicles market will also have consequences for the used vehicle market. Specifically, any action that raises prices for new vehicles will also tend to increase prices of used vehicles, and in turn cause owners of existing vehicles to keep them in service for slightly longer. In the case of the proposed rule, however, the agency estimates that the value of fuel savings over the lifetimes of the new vehicles will exceed the increase in their prices, prompting an increase in sales of new vehicles during most model years that the rule affects. As a consequence, prices for used vehicles are also likely to decline, leading to slight increases in the rate at which used vehicles are retired from service (“scrapped”) and replaced with new models. In turn, this will accentuate the effects of the proposed standards on fuel consumption and GHG emissions; at the same time, total criteria pollutant emissions from the entire vehicle fleet may also decrease, as newer, lower-polluting vehicles replace used vehicles.

Table VII-6a
Potential Impact on Sales
Passenger Cars

	MY 2012	MY 2013	MY 2014	MY 2015	MY 2016
Preferred	-74,443	-5,676	57,712	161,927	231,947
3%	-5,252	54,066	94,386	159,329	224,106
4%	-11,718	50,478	117,188	211,476	283,363
5%	-38,598	21,580	94,974	174,344	258,367
6%	-86,047	-38,494	33,912	104,557	180,969
7%	-92,687	-19,825	42,670	91,839	138,526
Max Net	-86,354	-2,282	50,530	111,953	170,943
TC = TB	-91,422	-11,138	39,302	86,253	140,837

Table VII-6b
Potential Impact on Sales
Light Trucks

	MY 2012	MY 2013	MY 2014	MY 2015	MY 2016
Preferred	16,385	58,394	120,758	180,702	222,573
3%	-11,721	16,813	76,678	126,235	160,669
4%	-12,465	23,582	101,551	161,511	204,491
5%	-23,194	3,080	65,276	143,737	190,941
6%	-20,427	-13,703	44,332	114,376	176,695
7%	-18,144	-24,607	38,771	106,095	143,315
Max Net	-23,364	8,829	66,568	120,438	157,645
TC = TB	-25,171	-3,062	52,431	100,321	142,025

Table VII-6c
Potential Impact on Sales
Passenger Cars and Light Trucks Combined

	MY 2012	MY 2013	MY 2014	MY 2015	MY 2016
Preferred	-58,058	52,719	178,470	342,628	454,520
3%	-16,973	70,879	171,064	285,564	384,776
4%	-24,183	74,060	218,739	372,986	487,854
5%	-61,792	24,660	160,250	318,081	449,309
6%	-106,474	-52,197	78,244	218,934	357,664
7%	-110,831	-44,432	81,441	197,934	281,841
Max Net	-109,718	6,546	117,098	232,391	328,587
TC = TB	-116,593	-14,200	91,733	186,574	282,862

Potential Impact on Employment

There are three potential areas of employment that fuel economy standards could impact. The first is the hiring of additional engineers by automobile companies and their suppliers to do research and development and testing on new technologies to determine their capabilities, durability, platform introduction, etc. The agency does not anticipate a huge number of incremental jobs in the engineering field. Often people would be diverted from one area to another and the incremental number of jobs might be a few thousand.

The second area is the impact that new technologies would have on the production line. Again, we don't anticipate a large number of incremental workers, as for the most part you are replacing one engine with another or one transmission with another. In some instances the technology is more complex, requiring more parts and there would be a small increase in the number of production employees, but we don't anticipate a large change.

The third area is the potential impact that sales gains or losses could have on production employment. This area is potentially much more sensitive to change than the first two areas discussed above. In order to get an estimate of potential job losses per sales loss, we examined recent U.S. employment (original equipment manufacturers and suppliers) and U.S. production. Total employment in 2000 reached a peak in the Motor Vehicle and Parts Manufacturing sector of the economy averaging 1,313,600 workers. Since then there has been a steady decline to 1,096,900 in 2006 and more rapid decreases in 2007, 2008, and 2009. Employment in 2008 was about two-thirds of the 2000 level and in the first six months of 2009 employment has been around 680,000, averaging about one-half of the peak in the year 2000. Table VII-7 shows how many vehicles are produced by the average worker in the industry. Averaging the information shown for 2000-2008, the average U.S. domestic employee produces 11.3 vehicles (the same number as in 2008). Thus, one could assume that projected sales loss divided by 11.3 would give an estimate of the potential employment loss.

Table VII-7

U.S. Light Duty Vehicle Production and Employment

	U.S. Light Vehicle Production	Motor Vehicle Vehicles and Parts Manufacturing U.S. Employment	Production per Employee
2000	12,773,714	1,313,600	9.7
2002	13,568,385	1,151,300	11.8
2004	13,527,309	1,112,700	12.2
2006	12,855,845	1,096,900	11.7
2008	9,870,473	876,300	11.3
Total/Average	62,595,726	5,550,800	

U.S. employment is from the Bureau of Labor Statistics.

http://data.bls.gov/PDQ/servlet/SurveyOutputServlet?series_id=CES3133600101&data_tool=XGtable

Combining MY 2012-2016, we estimate that the preferred alternative will result in a small net increase in sales (65,480), and thus employment (5,795). At this time, the agency considers these effects to occur in the short to medium term (meaning up to 5 years). Over the next few years, consumers can elect to defer vehicle purchases by continuing to operate existing vehicles. Eventually, however, the rising maintenance costs for aging vehicles will make replacements look more attractive.

However, vehicle owners may also react to persistently higher vehicle costs by permanently owning fewer vehicles, and keeping existing vehicles in service for somewhat longer. In this case, the possibility exists that there may be permanent sales losses, compared with a situation in which vehicle prices are lower.

Table VII-8
Impact on Auto Industry Employment by Alternative
Passenger Cars and Light Trucks Combined
(Jobs)

	MY 2012	MY 2013	MY 2014	MY 2015	MY 2016
Preferred	-5,138	4,665	15,794	30,321	40,223
3%	-1,502	6,272	15,138	25,271	34,051
4%	-2,140	6,554	19,357	33,008	43,173
5%	-5,468	2,182	14,181	28,149	39,762
6%	-9,422	-4,619	6,924	19,375	31,652
7%	-9,808	-3,932	7,207	17,516	24,942
Max Net	-9,710	579	10,363	20,566	29,079
TC = TB	-10,318	-1,257	8,118	16,511	25,032

Scrappage Rates

The effect of this rule on the use and scrappage of older vehicles will be related to its effects on new vehicle prices, the fuel efficiency of new vehicle models, and the total sales of new vehicles. If the value of fuel savings resulting from improved fuel efficiency to the typical potential buyer of a new vehicle outweighs the average increase in new models' prices, sales of new vehicles will rise, while scrappage rates of used vehicles will increase slightly. This will cause the "turnover" of the vehicle fleet – that is, the retirement of used vehicles and their replacement by new models – to accelerate slightly, thus accentuating the anticipated effect of the rule on fleet-wide fuel consumption and CO₂ emissions. However, if potential buyers value future fuel savings resulting from the increased fuel efficiency of new models at less than the increase in their average selling price, sales of new vehicles will decline, as will the rate at which used vehicles are retired from service. This effect will slow the replacement of used vehicles by new models, and thus partly offset the anticipated effects of the proposed rules on fuel use and emissions.

Because the agencies are uncertain about how the value of projected fuel savings from the proposed rules to potential buyers will compare to their estimates of increases in new vehicle prices, we have not attempted to estimate explicitly the effects of the rule on scrappage of older vehicles and the turnover of the vehicle fleet. We seek comment on the methods that might be used to estimate the effect of the proposed rule on the scrappage and use of older vehicles as part of the analysis to be conducted for the final rule.

VIII. BENEFITS FROM IMPROVED FUEL ECONOMY

Improving new vehicles' fuel efficiency provides direct benefits to their buyers and users by reducing fuel consumption and fuel costs throughout those vehicles' lifetimes, stimulating increased vehicle use through the fuel economy rebound effect, and increasing vehicles' driving range so that they require less frequent refueling. At the same time, the reduction in fuel use that results from requiring higher fuel economy also produces wider benefits to the U.S. economy by lowering the cost of economic externalities that result from U.S. petroleum consumption and imports, including reducing the price of petroleum, lowering the potential costs from disruption in the flow of oil imports, and possibly reducing federal outlays to secure imported oil supplies and cushion the U.S. economy against their potential interruption. Reducing fuel consumption also lowers the economic costs of environmental externalities resulting from fuel production and use, including reducing the impacts on human health from emissions of criteria air pollutants, and reducing future economic damages from potential changes in the global climate caused by greenhouse gas emissions.

These benefits are partly offset by the increase in fuel use that results from added vehicle use due to the fuel economy rebound effect, as well as by added costs from the increased congestion, crashes, and noise caused by increased vehicle use. They would also be offset by any loss in the utility that new vehicles provide to their buyers (and subsequent owners) as a consequence of reductions in their performance, carrying capacity, or comfort that manufacturers implement as part of their strategies to comply with higher fuel economy requirements. Nevertheless, the total economic benefits from requiring higher fuel economy are likely to be substantial, and the agency has attempted to quantify each of these components carefully.

NHTSA's analysis of alternative increases in the CAFE standards that would apply to MY 2012-2016 passenger cars and light trucks estimates the economic benefits from adopting more stringent CAFE standards separately for each model year over its lifespan in the U.S. vehicle fleet, extending from the initial year when a model year is offered for sale through the year when nearly all vehicles from that model year have been retired from service. Each category of benefits resulting from increased fuel economy is measured by comparing the future values of fuel consumption and its associated economic impacts under alternative increases in CAFE standards – and the corresponding improvements in fuel economy – to their value under the baseline alternative, which would extend current CAFE standards to apply to future model years, thus resulting in only minimal improvement in fuel economy.

Because these benefits occur throughout the lifetimes of vehicles whose fuel economy increases in response to higher CAFE standards, their projected values during each future year of their respective lifetimes must be discounted to their present values as of the time each model year is produced and sold in order to facilitate comparison to the costs incurred by vehicle manufacturers for improving fuel economy.¹⁸⁷ Thus the selection of an appropriate discount rate

¹⁸⁷ Discounting to the year when each model year was produced allows future economic benefits from improving each model year's fuel economy to be compared to added production costs for making those vehicles more fuel-efficient, which are assumed to be incurred at the time those vehicles are manufactured.

is also an important issue in the agency's analysis of benefits from requiring cars and light trucks to achieve higher fuel economy.

This chapter first discusses the forecasts, assumptions, and parameter values that NHTSA uses to analyze benefits from improved fuel economy. Because it plays a critical role in determining the magnitude of these benefits, this section also includes a detailed discussion of the fuel economy rebound effect and the agency's assumption about its magnitude. Next, the chapter discusses the methods the agency employs to estimate the direct benefits to vehicle buyers resulting from higher fuel economy, as well as the nature of potential welfare losses to buyers from changes in other vehicle characteristics that might accompany improvements in fuel economy. The chapter then details the procedures that are used to estimate broader benefits to the U.S. economy – and in the case of reductions in greenhouse gas emissions, the global economy – that result from lower fuel production and consumption. It also describes how the increases in external costs resulting from added vehicle use are calculated.

Finally, the chapter presents empirical estimates of the value of each of these benefits that the agency estimates would result from establishing alternative CAFE standards for MY 2012-2016 passenger cars and light trucks. These estimates are presented in physical units, as total undiscounted economic values of future benefits, and discounted to their present values using alternative discount rates.

A. The Effects of the Proposal on Consumer Welfare

There are two viewpoints for evaluating the costs and benefits of the proposed increase in CAFE standards: the private perspective of vehicle buyers themselves on the higher fuel economy levels the proposed rule would require, and the economy-wide or “social” perspective on the costs and benefits of requiring higher fuel economy. From the perspective of vehicle buyers, raising CAFE standards would impose significant costs in the form of higher prices for new vehicles, as manufacturers attempt to recover their added costs for producing vehicles with higher fuel efficiency. If vehicle manufacturers are unable to fully recover their higher costs for producing more fuel-efficient cars and light trucks through higher sales prices, they will bear part of these costs in the form of reduced “producer surplus” or short-term profits.

Other private costs from requiring higher fuel economy also result from changes in the welfare of potential vehicle buyers, as they respond to higher vehicle prices by purchasing different models or postponing their purchases of new vehicles. The effects of requiring higher fuel economy on consumer welfare also depend on whether manufacturers elect to make other changes in vehicle attributes as they comply with stricter CAFE standards, such as performance, passenger- and cargo-carrying capacity, comfort, or occupant safety. Although NHTSA believes it has employed estimates of costs for improving fuel economy that include adequate allowances for any accompanying modifications necessary to maintain new vehicles' current levels of other attributes, any changes in these attributes that manufacturers elect to make will represent additional private costs to vehicle buyers from requiring increased fuel economy.

At the same time, raising CAFE standards also provides important private benefits to vehicle buyers, mainly in the form of the values buyers assign to the future savings in fuel costs they

believe are likely to result from purchasing more fuel-efficient vehicles. Although these values are likely to vary significantly among buyers depending on their expectations about future fuel prices, how long they anticipate owning their vehicles, and how much they expect to drive, fuel savings are the primary source of private benefits from increased fuel economy. In addition, requiring new cars and light trucks to attain higher fuel economy will also provide benefits to their buyers through the increase in vehicle use associated with the fuel economy rebound effect, as well as from increases in vehicles' driving range, which allow drivers to refuel less frequently.

From the social perspective, the economic benefits and costs of establishing higher CAFE standards include not only these private benefits and costs, but also changes in the value of environmental and economic externalities that result from fuel consumption and vehicle use.¹⁸⁸ These include the reduction in potential climate-related economic damages resulting from lower CO₂ emissions, reduced damages to human health from lower emissions of criteria air pollutants, reductions in economic externalities associated with U.S. petroleum imports, and increases in traffic congestion, vehicle noise, and accidents caused by the increased driving that results through the fuel economy rebound effect.

NHTSA has estimated most elements of the private and social benefits and costs that will result from its proposal to establish higher CAFE standards for model years 2012 through 2016, and the agency reports detailed empirical estimates of these impacts in this document and its Preliminary Regulatory Impact Analysis for the proposed rule. However, the agency is unable to provide a definitive accounting of the private costs and benefits from establishing higher CAFE standards, because we are unable to estimate the losses in consumer welfare that are likely to result from the effects of higher prices for on the number of new vehicles sold or on the mix of specific vehicle models that buyers decide to purchase. Assuming that the agency has correctly estimated each of the other costs and benefits that will result from the proposed rule, its estimates of the net private and total (private plus social) benefits represent their maximum possible values, and considering the rule's impacts on consumer welfare would invariably *reduce* the agency's reported estimates of the proposed rule's net private and total benefits.

If the agency's estimates of technology costs are indeed adequate to maintain vehicles' current levels of these other attributes constant, the only changes in vehicles' characteristics resulting from higher CAFE standards will be improvements in the fuel economy and increases in sales prices for some (or perhaps even all) models. In this case, the welfare effects of requiring higher fuel economy depend on exactly how potential vehicle buyers value the future savings in fuel costs that they anticipate will result from purchasing vehicles with higher fuel economy.

If the market for new vehicles is perfectly competitive and consumers have reliable information to estimate the likely magnitude and value of future fuel savings from buying more efficient models, economic theory suggests that they will make correct trade-offs between higher initial

¹⁸⁸ Vehicle buyers are likely to value fuel savings using retail fuel prices, which include taxes levied by federal, state, and some local governments. Because the reduction in these tax payments resulting from lower fuel purchases is exactly offset by lower tax revenues to government agencies (and reduced spending on the transportation infrastructure and other investments financed by fuel taxes), it does not represent a net benefit from the perspective of the U.S. economy as a whole. Thus the social costs of requiring higher fuel efficiency also include an adjustment to reflect the reduction in fuel tax revenues that results from reduced fuel purchases by new-car buyers.

costs for purchasing more fuel-efficient vehicles and subsequent reductions in their operating costs. These include lower fuel expenditures, savings in the time they spend refueling, and the benefits from any additional driving they do in response to its lower per-mile cost. The assumption that consumers have adequate information, foresight, and capability to make such trade-offs has been challenged on both theoretical and empirical grounds. If this assumption is accurate, however, no net private benefits can result from requiring higher fuel economy, since doing so will alter both the purchase prices of new cars and their lifetime streams of operating costs in ways that will inevitably reduce consumers' well-being.

The essence of this view is that in the absence of the regulation, consumers fully understand their current and future costs for owning and using vehicles, and make tradeoffs between these that maximize their individual welfare. From this viewpoint, CAFE standards – or any other regulation that alters this trade-off – will reduce their private well being. The intuition behind this conclusion is probably best captured by recognizing that automobile manufacturers currently sell a wide range of vehicle models, including many that already comply with the CAFE standards proposed in this rule. Yet sufficiently few buyers elect to purchase these vehicles that the average fuel economy of new vehicles sold today remains well below the levels this rule would require.

On the other hand, a great deal of recent evidence suggests that many consumers do not accurately trade off current and future costs of owning and operating cars. For example, it appears that some buyers do not know how to estimate future savings in fuel costs from purchasing a higher-MPG vehicle, or that they incorrectly estimate the increased expense of purchasing a more fuel-efficient new car. In this situation, higher CAFE standards – which will increase purchase prices for new cars, but reduce their lifetime operating costs – can indeed improve consumers' financial well-being. If these circumstances are widespread, then it is likely that requiring manufacturers to achieve higher fuel economy can increase private well-being, and thus that potentially significant savings in private costs can result from the proposed rule.

Whether these circumstances are indeed typical is largely a question of the values that consumers place on additional fuel economy. NHTSA is not currently in a position to reach a conclusive judgment on this issue, and is thus unable to determine how requiring higher fuel economy levels is likely to affect consumer welfare, even if the only impacts of the proposed rule are to change the sales prices and fuel economy levels of new cars and light trucks, as the agency assumes.

Even if these are the only changes that result from the proposed rule, however, changes in the sales prices and fuel economy levels of some new vehicle models are likely to affect some potential buyers' decisions about whether to purchase a car and what type or model to purchase. Research has demonstrated that previous CAFE rules and market-based changes in operating costs (for example, resulting from changes in gasoline prices) lead consumers to alter the number and types of cars they purchase, and that these changes can lead to losses in consumer well-being. However, NHTSA is not currently able to provide empirical estimates of the magnitude of potential losses in vehicle buyers' welfare resulting from postponement of their decisions to purchase new vehicles or changes in the specific models they elect to buy.

For both of these reasons, the likely impacts of adopting higher CAFE standards on consumer welfare remain unknown. Because changes in consumer welfare are an important component of the total private costs and benefits resulting from higher standards, the magnitude and even the direction of the net private economic impact of adopting stricter CAFE standards also remains unknown.

How Do Consumers Value Fuel Economy?

For this proposed rule, NHTSA estimates several sources of private benefits to vehicle buyers, including savings in future fuel costs, the value of time saved due to less frequent refueling, and utility gained from additional travel that results from the rebound effect. In combination, the agency's estimates suggest that these private savings greatly outweigh its estimates of the costs to consumers for providing higher fuel economy, even without accounting for the additional social benefits from higher fuel economy. This is due primarily to the very large estimated value of future fuel savings from higher fuel economy, which in turn partly reflects the agency's use of modest discount rates (3% and 7%).

Even without considering the unmeasured welfare losses likely to result from changes in the number of new cars sold and the specific models purchased, however, this finding presents a conundrum. On the one hand, requiring higher fuel economy levels appears likely to produce large net benefits, primarily because the increased cost of producing more fuel-efficient cars and light trucks appears to be far outweighed by the value of the future fuel savings projected to result from higher fuel economy (assuming modest discount rates). At the same time, however, vehicle manufacturers currently produce many models that would allow them to meet the proposed higher CAFE standards, yet at least on average, buyers reveal a preference for lower fuel economy than the proposed rule would require.

In this situation, often referred to as the Energy Efficiency Paradox, consumers appear not to purchase products that are in their economic self-interest. There are theoretical reasons that could explain such behavior: consumers may be myopic, and thus undervalue the long term; they might lack information or be unable to use it properly even when it is presented to them; they may be particularly averse to potential short-term losses associated with purchasing energy-efficient products (the behavioral phenomenon of "loss aversion"); or even if consumers have relevant knowledge, the benefits of energy efficient vehicles might not seem sufficiently important to them at the time they decide to purchase a new car. A great deal of work in behavioral economics has suggested the possibility that factors of this sort help account for the Energy Efficiency Paradox.

Another possible explanation for the paradox between the apparently large private benefits to vehicle buyers from requiring higher fuel economy and the reluctance of many buyers to purchase new vehicles with higher fuel economy is that consumers may apply much higher discount rates than the agency has used when they evaluate future cost savings from purchasing more fuel-efficient vehicles or other capital goods offering gains in energy efficiency. For example, the Energy Information Agency (1996) has used discount rates as high as 111 percent for water heaters and 120 percent for electric clothes dryers.¹⁸⁹

¹⁸⁹ Energy Information Administration, U.S. Department of Energy (1996). Issues in Midterm Analysis and

Some evidence also suggests directly that vehicle buyers employ high discount rates: consumers surveyed by Kubik (2006) reported that fuel savings would have to be adequate to pay back the additional purchase price of a more fuel-efficient vehicle in less than 3 years to persuade a typical buyer to purchase it.¹⁹⁰ In short, there appears to be no consensus in the literature on what the private discount rate should be in the context of vehicle purchase decisions.

Another possible reconciliation of the Energy Efficiency Paradox, which poses a significant complication for evaluating the private benefits resulting from higher CAFE Standards, is that the values consumers place on the future savings from higher fuel economy may vary sufficiently widely that it is unclear whether on average this value exceeds the costs of providing higher fuel economy. A 1988 review of consumers' willingness to pay for improved fuel economy found estimates that varied by more than an order of magnitude: for a \$1 per year reduction in vehicle operating costs, consumers would be willing to spend between \$0.74 and \$25.97 in increased vehicle price.¹⁹¹ (For comparison, the present value of saving \$1 per year on fuel for 15 years at a 3% discount rate is \$11.94, while a 7% discount rate produces a present value of \$8.78.) Thus, this study finds that some consumers appear to be willing to pay far too much to obtain future fuel savings, while others may be willing to pay far too little.

Although NHTSA has not found an updated survey of these values, a few examples suggest that vehicle choice models also imply wide variation in estimates of how much people are willing to pay for fuel savings. For instance, Espey and Nair (2005) and McManus (2006) find that consumers are willing to pay nearly \$600 extra to purchase a vehicle that achieves one additional mile per gallon.¹⁹² In contrast, Gramlich (2008) finds that consumers' willingness to pay for an increase from 25 mpg to 30 mpg varies between \$4100 (for luxury cars when gasoline costs \$2/gallon) to \$20,560 (for SUVs when gasoline costs \$3.50/gallon).¹⁹³ Thus some buyers appear not to make accurate trade-offs between higher initial purchase prices and subsequent fuel savings. At the same time, however, these results may simply reflect the fact that the expected savings from purchasing higher fuel economy vary widely among individuals, because they travel different amounts or have different driving styles.

Finally, it is possible that the apparent Energy Efficiency Paradox is in fact not a paradox at all when one considers the uncertainty surrounding future fuel prices and a vehicle's expected lifetime and usage. As Metcalf and Rosenthal (1995) indicate, purchasing higher fuel economy requires buyers to weigh known, up-front costs that are essentially irreversible (that is, they have

Forecasting 1996, DOE/EIA-0607(96), Washington, D.C., <http://www.osti.gov/bridge/purl.cover.jsp?purl=/366567-BvCFp0/webviewable/>, accessed 7/7/09.

¹⁹⁰ Kubik, M. (2006). *Consumer Views on Transportation and Energy*. Second Edition. Technical Report: National Renewable Energy Laboratory.

¹⁹¹ Greene, David L., and Jin-Tan Liu (1988). "Automotive Fuel Economy Improvements and Consumers' Surplus." *Transportation Research Part A* 22A(3): 203-218. The study actually calculated the willingness to pay for reduced vehicle operating costs, of which vehicle fuel economy is a major component.

¹⁹² Espey, Molly, and Santosh Nair (2005). "Automobile Fuel Economy: What is it Worth?" *Contemporary Economic Policy* 23(3): 317-323; McManus, Walter M. (2006). "Can Proactive Fuel Economy Strategies Help Automakers Mitigate Fuel-Price Risks?" University of Michigan Transportation Research Institute.

¹⁹³ Gramlich, Jacob (2008). "Gas Prices and Endogenous Product Selection in the U.S. Automobile Industry," <http://www.econ.yale.edu/seminars/apmicro/am08/gramlich-081216.pdf>, accessed 5/11/09.

a relatively low salvage value if the return never materializes) against an unknown future stream of fuel savings.¹⁹⁴ They find some evidence that this accounts for a large portion of the seeming inconsistency between low cost opportunities to invest in energy efficiency and the current lack of investment in them. This would not imply failure on the part of consumers in making decisions, but rather that the rate of return buyers require on their vehicle purchases (or other energy efficiency investments) is much higher than that implied by a 3 percent discount rate that does not include a provision for uncertainty.

Greene et al. (2009) find additional support for this conclusion in the context of fuel economy decisions: They find that the expected net present value of increasing the fuel economy of a passenger car from 28 to 35 miles per gallon falls from \$405 when calculated using standard net present value calculations to nearly zero when uncertainty regarding future cost savings is taken into account.¹⁹⁵ In contrast to Metcalf and Rosenthal, Greene et al. find that uncertainty regarding the future price of gasoline is less important than uncertainty surrounding the expected lifetimes of new vehicles. Supporting this hypothesis is a finding by Dasgupta et al. (2007) that consumers are more likely to lease than buy a vehicle with higher maintenance costs, because leasing provides them with the option to return it before those costs become too high.¹⁹⁶

In contrast, other research suggests that the Energy Efficiency Paradox is real and significant, and owes to consumers' inability to value future fuel savings appropriately. For example, Sanstad and Howarth (1994) argue that consumers optimize behavior without full information by resorting to imprecise but convenient rules of thumb. Larrick and Soll (2008) find evidence that consumers do not understand how to translate changes in miles per gallon into fuel savings.¹⁹⁷ If the behavior identified in these studies is indeed widespread, then significant gains to consumers can result from requiring higher fuel economy.

How NHTSA Proposes to Treat the Issue of Welfare Losses

In the course of future rulemakings, the agency intends to explore methods that would allow it to present a more comprehensive accounting of private costs and benefits from requiring higher fuel economy, including more detailed estimates of changes in the welfare of new vehicle buyers that are likely to result from higher CAFE standards. One promising approach to estimating the full welfare loss associated with CAFE's impact on vehicle purchasing decisions is using consumer vehicle choice models to evaluate the simultaneous effects of increases in sales prices, improvements in fuel economy, and changes in other attributes of specific vehicle models, rather than in the average values of these variables. NHTSA invites comments on the state of the art of

¹⁹⁴ Metcalf, G., and D. Rosenthal (1995). "The 'New' View of Investment Decisions and Public Policy Analysis: An Application to Green Lights and Cold Refrigerators," *Journal of Policy Analysis and Management* 14: 517–531.

¹⁹⁵ Greene, D., J. German, and M. Delucchi (2009). "Fuel Economy: The Case for Market Failure" in *Reducing Climate Impacts in the Transportation Sector*, Sperling, D., and J. Cannon, eds. Springer Science.

¹⁹⁶ Dasgupta, S., S. Siddarth, and J. Silva-Risso (2007). "To Lease or to Buy? A Structural Model of a Consumer's Vehicle and Contract Choice Decisions." *Journal of Marketing Research* 44: 490 – 502.

¹⁹⁷ Sanstad, A., and R. Howarth (1994). "'Normal' Markets, Market Imperfections, and Energy Efficiency." *Energy Policy* 22(10): 811-818; Larrick, R. P., and J.B. Soll (2008). "The MPG illusion." *Science* 320: 1593-1594.

consumer vehicle choice modeling, as well as on the prospects for these models to yield reliable estimates of changes in consumer welfare from requiring higher fuel economy.

B Basic Inputs for Analysis of Economic Impacts

The magnitudes and economic values of these benefits and costs from increased fuel economy are influenced by a number of forecast variables, parameter values, and assumptions. These include the level of vehicle sales during each model year affected by higher CAFE standards, the relationship between increases in these vehicles' EPA-measured fuel efficiency and their actual on-road fuel efficiency, assumptions about the lifetimes and usage of future model-year vehicles, the magnitude of the fuel economy rebound effect, future fuel prices and taxes, the values of economic externalities resulting from petroleum consumption and imports, the economic values of environmental externalities resulting from fuel production, distribution, and use, the value of increased refueling range, and the discount rate applied to future benefits and costs. The following sections discuss the specific forecasts, parameter values, and assumptions NHTSA has employed to estimate benefits and costs from alternative CAFE standards that would require increases in the fuel economy of passenger cars and light trucks produced during model years 2012 through 2016.

Projected Sales of MY 2012-2016 Passenger Cars and Light Trucks

A critical variable affecting the total economic benefits from requiring improvements in passenger car and light truck fuel economy is the number of vehicles likely to be produced under stricter CAFE standards. Projections of total passenger car and light truck sales for future years (see Table VIII-1a and VIII-1b) were obtained from the Energy Information Administration's (EIA) *Annual Energy Outlook 2009 (AEO 2009)*, a standard government reference for projections of energy production and consumption in different sectors of the U.S. economy.¹⁹⁸ In using these forecasts, NHTSA made the simplifying assumption that projected sales of cars and light trucks during each calendar year from 2012 through 2016 represented the likely production volumes for the corresponding model year. The agency did not attempt to establish the exact correspondence between projected sales during individual calendar years and production volumes for specific model years.

NHTSA estimated production volumes of passenger cars and light trucks for individual manufacturers by first calculating their respective shares of total production for each model year. These shares were calculated by dividing each manufacturer's planned car or light truck production volumes by the sum of planned production volumes reported by all manufacturers.¹⁹⁹ Next, the resulting estimates of individual manufacturer's shares of total car and light truck production during a model year were applied to forecast total car and light truck sales for the

¹⁹⁸ U.S. Department of Energy, Energy Information Administration, *Annual Energy Outlook 2009*, Updated Reference Case (April 2009), Supplemental Table 57, http://www.eia.doe.gov/oiaf/aeo/supplement/stimulus/arra/excel/suptab_57.xls (last accessed July 24, 2009).

¹⁹⁹ These product plans are submitted to NHTSA in response to the agency's request for information from vehicle manufacturers, and include responses to very detailed questions about vehicle model characteristics that influence fuel economy. The baseline market forecast mix of products (make/model, engines, transmissions, etc.) that NHTSA has used in its analysis is based on the confidential product plan information manufacturers submit to the agency.

corresponding calendar year from *AEO 2009*. This produces estimates of passenger car and light truck production by each manufacturer during each model year from 2012 through 2016. NHTSA employs this process in order to develop production forecasts that are consistent with both the production plans that individual manufacturers reported to the agency, and the forecasts of total sales of new cars and light trucks reported by the Energy Information Administration in *AEO 2009*.²⁰⁰

Changes in Vehicle Classification

Passenger automobiles were defined in the Energy Policy and Conservation Act of 2007 (EPCA) as “any automobile (other than an automobile capable of off-highway operation) which the Secretary [*i.e.*, NHTSA] decides by rule is manufactured primarily for use in the transportation of not more than 10 individuals.” Thus there are two general groups of automobiles that qualify under EPCA as non-passenger automobiles or light trucks: (1) those defined by NHTSA in its regulations as other than passenger automobiles because they were not manufactured “primarily” for transporting up to ten individuals; and (2) those expressly excluded from the passenger category by statute due to their capability for off-highway operation, regardless of whether they were manufactured primarily for passenger transportation. NHTSA’s classification rule directly tracks those two groups of non-passenger automobiles in subsections (a) and (b), respectively, of 49 CFR Part 523.5.

In developing its proposed CAFE standards for model years 2012-2016, NHTSA has tightened the coverage of its regulatory definition of “light truck” to ensure that 2 wheel drive (2WD) versions of an SUV are not classified as light trucks under Part 523.5(b) simply because that same SUV model is also available in a 4WD version.²⁰¹ In addition, 2WD SUVs may not be properly classified as light trucks simply because a manufacturer asserts that their base form has no back seat and thus would “provide greater cargo-carrying than passenger-carrying volume” according to Part 523.5(a)(4). No change in the regulatory definition of a light truck is necessary to implement this clarification. It results in the re-classification of an average of 1,400,000 2WD SUVs from light trucks to passenger cars in each of the five model years that would be covered by the alternative standards considered in this rulemaking.

Adjusted Sales Forecasts

Tables VIII-1a and VIII-1b report forecast production volumes of passenger cars and light trucks for each manufacturer during model years 2012 through 2016. The figures reported in these tables reflect the AEO 2009 Reference Case forecasts of passenger car and light truck sales for 2012-2016, the planned production volumes for model years 2012-2106 reported to NHTSA by individual manufacturers, and the reclassification of certain light truck models as passenger cars.

²⁰⁰ For manufacturers that did not submit plans, planned production volumes for model years 2012-2016 were assumed to be the same as their model year 2008 production volumes as recorded in NHTSA’s CAFE compliance database.

²⁰¹ In order to be properly classifiable as a light truck under Part 523, a 2WD SUV must either be over 6,000 lbs GVWR and meet 4 out of 5 ground clearance characteristics to make it off-highway capable under Part 523.5(b), or meet one of the functional characteristics under Part 523.5(a) (*e.g.*, greater cargo carrying capacity than passenger carrying capacity). In other words, a 2WD vehicle of 6,000 lbs GVWR or less, even if it has a sufficient number of clearance characteristics, cannot be considered off-highway capable.

The tables also reflect the reasonable assumption that while sales of cars or light trucks produced during a *model* year will be distributed over more than one *calendar* year, production and sales for each model year will ultimately be equal.

Table VIII-1a
Sales Projections – Passenger Cars
(1,000s of vehicles)

Manufacturer	MY 2011	MY 2012	MY 2013	MY 2014	MY 2015	MY 2016
BMW	273	283	323	352	372	381
Chrysler	194	179	175	169	137	139
Daimler	177	172	190	204	230	235
Ford	1,230	1,348	1,424	1,446	1,503	1,511
General Motors	1,156	1,485	1,620	1,709	1,790	1,820
Honda	996	1,155	1,353	1,493	1,562	1,593
Hyundai	570	581	559	563	591	597
Kia	302	305	310	331	348	351
Mazda	318	313	319	338	340	345
Mitsubishi	68	65	61	56	52	53
Nissan	794	959	1,032	1,073	1,104	1,123
Porsche	31	32	36	38	36	37
Subaru	154	149	136	135	131	131
Suzuki	91	87	86	81	76	77
Tata	19	23	33	36	41	42
Toyota	1,474	1,698	1,862	1,985	2,114	2,154
Volkswagen	388	423	459	468	465	477
Total	8,235	9,256	9,977	10,479	10,891	11,068

Table VIII-1b
Sales Projections – Light Trucks
(1,000s of vehicles)

Manufacturer	MY 2011	MY 2012	MY 2013	MY 2014	MY 2015	MY 2016
BMW	140	143	142	144	139	136
Chrysler	403	282	244	223	112	110
Daimler	98	109	116	125	113	111
Ford	944	1,026	1,108	1,202	1,231	1,202
General Motors	1,314	1,210	1,320	1,343	1,356	1,323
Honda	571	670	725	687	692	675
Hyundai	127	141	136	134	133	130
Kia	98	79	75	72	70	68
Mazda	60	72	71	67	59	58
Mitsubishi	9	10	11	9	7	7
Nissan	421	478	479	475	454	444
Porsche	21	21	21	19	17	17
Subaru	118	89	78	77	73	74
Suzuki	25	30	30	31	27	27
Tata	31	42	46	53	49	47
Toyota	1,059	1,019	1,019	1,046	1,081	1,058
Volkswagen	108	109	101	104	103	100
Total	5,547	5,531	5,720	5,811	5,717	5,587

The Magnitude of the Rebound Effect

The fuel economy rebound effect refers to the fraction of fuel savings expected to result from an increase in vehicle fuel economy – particularly an increase required by the adoption of higher CAFE standards – that is offset by additional vehicle use. The increase in vehicle use occurs because higher fuel economy reduces the fuel cost of driving, typically the largest single component of the monetary cost of operating a vehicle, and vehicle owners respond to this reduction in operating costs by driving slightly more. By lowering the marginal cost of vehicle use, improved fuel economy leads to an increase in the number of miles vehicles are driven each year and over their lifetimes. Even with their higher fuel economy, this additional driving consumes some fuel, so the rebound effect reduces the net fuel savings that result when new CAFE standards require manufacturers to improve fuel economy.

The rebound effect – originally termed the “take back” effect – expresses the fraction of fuel savings expected to result from an increase in vehicle fuel economy that is offset by additional vehicle use. This measure also equals the percentage by which annual vehicle use increases when the fuel cost of driving each mile declines in response to higher fuel economy. Mathematically, the rebound effect is the elasticity of total or average vehicle use with respect to either fuel economy itself or fuel cost per mile driven, expressed as a positive percentage (rather than a decimal number, the usual convention for expressing elasticities). Because the fuel cost of driving each mile is equal to fuel price per gallon divided by fuel economy in miles per gallon, it is easy to understand why this measure declines and vehicle use increases in response to increased fuel economy.

The magnitude of the rebound effect is an important determinant of the actual fuel savings that are likely to result from adopting stricter CAFE standards, and thus an important parameter affecting NHTSA’s evaluation of alternative standards for future model years. Research on the magnitude of the rebound effect in light-duty vehicle use dates to the early 1980s, and almost unanimously concludes that a statistically significant rebound effect occurs when vehicle fuel efficiency improves.²⁰²

The most common approach to estimating its magnitude has been to analyze household survey data on vehicle use, fuel consumption, fuel prices, and other determinants of household travel demand to isolate the response of vehicle use to higher fuel economy. Several other studies have relied on econometric analysis of annual U.S. data on vehicle use, fuel economy, fuel prices, and other variables to identify the response of average vehicle use to changes in fleet-wide average fuel economy. Two recent studies analyzed yearly variation in vehicle ownership and use, fuel prices, and fuel economy among individual states over an extended time period in order to measure the response of vehicle use to changing fuel economy and other factors.²⁰³

²⁰² Some studies estimate that the long-run rebound effect is significantly larger than the immediate response to increased fuel efficiency. Although their estimates of the adjustment period required for the rebound effect to reach its long-run magnitude vary, this long-run effect is most appropriate for evaluating the fuel savings and emissions reductions resulting from stricter standards that would apply to future model years.

²⁰³ In effect, these studies treat U.S. states as a data “panel” by applying appropriate estimation procedures to data consisting of each year’s average values of these variables for the separate states.

An important distinction among studies of the rebound effect is whether they assume that the effect is constant, or is likely to vary over time in response to the absolute levels of fuel costs, personal income, or household vehicle ownership. Most studies using aggregate annual data for the U.S. assume a constant rebound effect, although some of these studies test whether the effect varies in response to changes in retail fuel prices or average fuel economy. Many studies using household survey data estimate significantly different rebound effects for households owning varying numbers of vehicles and thus imply that its average value will change over time as vehicle ownership patterns evolve.

However, these studies arrive at differing conclusions about whether the rebound effect is larger among households that own more vehicles, and thus provide conflicting estimates of changes in its magnitude as the distribution of households by vehicle ownership levels changes. One recent study using state-level data concludes that the rebound effect varies directly in response to changes in personal income and the degree of urbanization of U.S. cities, as well as in response to fuel costs.

In order to arrive at an estimate of the rebound effect for use in assessing the fuel savings, emissions reductions, and other impacts of alternative standards, NHTSA reviewed 22 studies of the rebound effect conducted from 1983 through 2005. The agency then conducted a detailed analysis of the 66 separate estimates of the long-run rebound effect reported in these studies, which is summarized in Table VIII-2 below.²⁰⁴ As the table indicates, these 66 estimates of the long-run rebound effect range from as low as 7 percent to as high as 75 percent, with a mean value of 23 percent. Estimates of the rebound effect reported in the 17 published studies show the same range, but a slightly higher mean value (24 percent). Although this result is not shown in the table, approximately two-thirds of all the estimates reviewed and of all published estimates fall in the range of 10-30 percent.

²⁰⁴ In some cases, NHTSA derived estimates of the overall rebound effect from more detailed results reported in the studies. For example, where studies estimated different rebound effects for households owning different numbers of vehicles but did not report an overall value, we computed a weighted average of the reported values using the reported distribution of households among vehicle ownership categories.

**Table VIII-2
Summary of Previous Rebound Effect Estimates**

Category of Estimates	Number of Studies	Number of Estimates	Range		Distribution		
			Low	High	Median	Mean	Std. Dev.
All Estimates	22	66	7%	75%	22%	23%	14%
Published Estimates	17	50	7%	75%	22%	24%	14%
U.S. Time-Series Data	7	34	7%	45%	14%	18%	9%
Household Survey Data	13	23	9%	75%	31%	31%	16%
Pooled U.S. State Data	2	9	8%	58%	22%	25%	14%
Constant Rebound Effect ⁽¹⁾	15	37	7%	75%	20%	23%	16%
Variable Rebound Effect ⁽¹⁾	10	29	10%	45%	23%	23%	10%

⁽¹⁾ Three studies estimated both constant and variable rebound effects.

As Table VIII-2 illustrates, the type of data used and authors' assumption about whether the rebound effect varies over time have important effects on its estimated magnitude. The 34 estimates derived from analysis of U.S. annual time-series data have a mean of 18 percent, while the mean of 23 estimates based on household survey data is 31 percent, and the mean of 9 estimates based on pooled state data (25 percent) is slightly above that of the entire sample. The average mean is 23 percent for both the 37 estimates that assume a constant rebound effect and the 29 estimates reported in studies that allow the rebound effect to vary in response to fuel prices, vehicle ownership, or household income.

Recent studies provide some evidence that the rebound effect has been declining over time, and it may decline further over the immediate future if income rises faster than gasoline prices. This result seems plausible, because the responsiveness of vehicle use to variation in fuel costs would be expected to decline as they account for a smaller proportion of the total monetary cost of driving, which has been the case until very recently. At the same time, rising personal incomes would be expected to reduce the sensitivity of vehicle use to fuel costs as the time component of driving costs – which is likely to be related to income levels – accounts for a larger fraction of the total cost of automobile travel. The widely-cited study by Small and Van Dender estimated that the long-run rebound effect averaged 22 percent over the period from 1966-2001, but declined to 11 percent over the last five years of that period (1997-2001).²⁰⁵ These authors subsequently reported that the long-run rebound effect appears to have dropped further to 6 percent over the period from 2000-2004.²⁰⁶

To provide additional insight into the rebound effect for the purposes of this rulemaking, NHTSA developed several new estimates of its magnitude. These estimates were developed by estimating and testing several econometric models of the relationship between vehicle miles-

²⁰⁵ Small, K. and K. Van Dender, 2007a. "Fuel Efficiency and Motor Vehicle Travel: The Declining Rebound Effect", *The Energy Journal*, vol. 28, no. 1, pp. 25-51.

²⁰⁶ Small, K. and K. Van Dender, 2007b. "Long Run Trends in Transport Demand, Fuel Price Elasticities and Implications of the Oil Outlook for Transport Policy," OECD/ITF Joint Transport Research Centre Discussion Papers 2007/16, OECD, International Transport Forum.

traveled and factors that influence it, including household income, fuel prices, vehicle fuel efficiency, road supply, the number of vehicles in use, vehicle prices, and other factors. As the studies by Small and Van Dender emphasize, it is important to account for the effect of fuel prices on vehicle buyers' demand for fuel efficiency when attempting to estimate the rebound effect. Failing to incorporate the response of fuel efficiency to fuel prices is likely to cause the rebound effect to be overestimated, because the changes in fuel economy resulting from variation in fuel prices partly offset the latter's effect on fuel cost per mile.

NHTSA's analysis used national aggregate data on light-duty vehicle travel covering the period from 1950 through 2006. Several different approaches were used to estimate the effect of fuel efficiency on car and light truck use, and various econometric procedures were employed to account for its relationship to fuel prices and control for the effect of this relationship on the estimated value of the rebound effect. The results from NHTSA's analysis are presented in Table VIII-3. For each model that was estimated, the table reports the average value of the rebound effect over the period from 1950-2006, as well as its value during the final year of that period. In addition, the table reports the average projected values of rebound effect between 2010 and 2030, which were developed using forecasts of personal income, fuel prices, and fuel efficiency from EIA's *Annual Energy Outlook 2009* Reference Case.

The results of NHTSA's analysis are broadly consistent with the findings from previous research summarized above. The historical average long-run rebound effect is estimated to range from 16-30%, and comparing these estimates to its calculated values for 2006 (which range from 8-14%) supports the finding from recent research that it is declining in magnitude. The forecast values of the rebound effect shown in the table, which range from 4-16%, also suggest that this decline is likely to continue through 2030.

EPA and NHTSA also seek comment on other alternatives for estimating the rebound effect. As one illustration, variation in the price per gallon of gasoline directly affects the per-mile cost of driving, and drivers may respond just as they would to a change in the cost of driving resulting from a change in fuel economy, by varying the number of miles they drive. Because vehicles' fuel economy is fixed in the short run, variation in the number of miles driven in response to changes in fuel prices will be reflected in changes in gasoline consumption. Under the assumption that drivers respond similarly to changes in the cost of driving whether they are caused by variation in fuel prices or fuel economy, the short-run price elasticity of demand for gasoline – which measures the sensitivity of gasoline consumption to changes in its price per gallon – may provide some indication about the magnitude of the rebound effect itself. The agencies also invite comment on the extent to which the short run elasticity of demand for gasoline with respect to its price can provide useful information about the size of the rebound effect. Specifically, the agencies seek comment on whether it would be appropriate to use the price elasticity of demand for gasoline, or other alternative approaches, to guide their choice of a value for the rebound effect.

Table VIII-3
Summary of NHTSA Estimates of the Long-Run Rebound Effect
Using U.S. Annual Data for 1950-2006

Model	VMT Measure	Variables Included in VMT Equation	Estimation Technique	Rebound Effects:		
				1950-2006	2006	2010-2030*
Small-Van Dender single VMT equation	annual VMT per adult	fuel cost per mile, per Capita income, vehicle stock, road miles per adult, fraction of population that is adult, fraction of population living in urban areas, fraction of population living in urban areas with heavy rail, dummy variables for fuel rationing, time trend	OLS	33.0%	15.8%	8.0%
Small-Van Dender three-equation system	annual VMT per adult	fuel cost per mile, per Capita income, vehicle stock, road miles per adult, fraction of population that is adult, fraction of population living in urban areas, fraction of population living in urban areas with heavy rail, dummy variables for fuel rationing, time trend	3SLS	21.6%	5.8%	3.4%
Single-equation VMT model	annual VMT per adult	personal income, road miles per Capita, time trend	OLS	18.4%	11.7%	9.2%
Single-equation VMT model	annual VMT per vehicle	fuel cost per mile, personal income, road miles per Capita, time trend	OLS	17.6%	15.2%	15.7%
Single-equation VMT model	annual VMT per adult	fuel cost per mile, personal income, road miles per Capita, dummy variables for fuel rationing, time trend	OLS	34.0%	20.8%	13.6%
Single-equation VMT model	annual VMT per vehicle	fuel cost per mile, personal income, vehicles per road mile, % of fleet manufactured under CAFE standards, new vehicle prices	IV (for fuel cost per mile)	16.3%	9.2%	7.0%
Three-equation system for VMT, fuel efficiency, and vehicle	annual VMT per vehicle	fuel cost per mile, personal income, vehicles per capita, vehicles per road mile, fraction of adult population licensed to drive, new vehicle prices, % of fleet	2SLS	29.5%	13.4%	15.9%

stock		manufactured under CAFE standards				
Three-equation system for VMT, fuel efficiency, and vehicle stock	annual VMT per vehicle	fuel cost per mile, personal income, vehicles per capita, vehicles per road mile, fraction of adult population licensed to drive, new vehicle prices, % of fleet manufactured under CAFE standards	3SLS	29.8%	13.7%	16.2%
Three-equation system for VMT, fuel efficiency, and vehicle stock	annual VMT per vehicle	fuel cost per mile, personal income, vehicles per capita, vehicles per road mile, fraction of adult population licensed to drive, new vehicle prices, % of fleet manufactured under CAFE standards	Vector auto-regression	19.9%	10.8%	
Three-equation system for VMT, fuel efficiency, and vehicle stock	annual VMT per vehicle	fuel cost per mile, personal income, vehicles per capita, vehicles per road mile, fraction of adult population licensed to drive, new vehicle prices, % of fleet manufactured under CAFE standards	Vector error-correction	20.7%	11.2%	

*Using AEO2009 Reference Case forecasts of fuel prices, fuel economy, and personal income.

In light of these results, NHTSA has elected to use a 10 percent rebound effect in its analysis of fuel savings and other benefits from higher CAFE standards for MY 2012-2016 vehicles. The agency's judgment is that the apparent decline over time in the magnitude of the rebound effect justifies using a value for future analysis that is lower than historical estimates, which average approximately 25 percent. Because the lifetimes of vehicles affected by the alternative CAFE standards considered in this rulemaking will extend from 2012 until approximately 2050, a value that is significantly lower than historical estimates appears to be appropriate. Recognizing the uncertainty surrounding its 10 percent estimate, the agency has analyzed the sensitivity of its benefits estimates to a range of values for the rebound effect from 5 percent to 15 percent.

One possible alternative to attempting to estimate the rebound effect *per se* would be to use the price elasticity of demand for gasoline, which measures the sensitivity of gasoline consumption to a change in its price, in order to establish a lower bound on its magnitude. The elasticity of gasoline demand with respect to its price per gallon is likely to provide a reasonable proxy for the rebound effect, since a decline in the price of gasoline has exactly the same effect on the per-mile cost of driving as an equivalent increase in fuel economy. In the very short run, the only way that people can respond to changes in the price of gasoline is to alter the number of

miles they drive.²⁰⁷ Over the relatively short time span of several months, most estimates indicate that the price elasticity of demand for gasoline is approximately -0.1, which corresponds to the short-run rebound effect of 10 percent used in this NPRM. Over the period of a year, however, the price elasticity of demand is likely to increase somewhat in magnitude, up to a range of -0.3 to -0.4.²⁰⁸ It seems reasonable to assume that the majority of the change in gasoline consumption over such a period results from changes in vehicle use, as distinguished from changes in the fuel economy of new vehicles, since only about 5-10 percent of the fleet would be replaced within one year. We seek comment on the advantages and disadvantages of using the price elasticity of demand for gasoline as a proxy for the magnitude of the rebound effect.

Additionally, NHTSA recognizes that as the world price of oil falls in response to lower U.S. demand for oil, there is the potential for an increase in oil use and, in turn, greenhouse gas emissions outside the U.S. This so called international oil “take back” effect is difficult to estimate. Given that oil consumption patterns vary across countries, there will be different demand responses to a change in the world price of crude oil. In addition, many countries around the world subsidize their oil consumption. It is not clear how oil consumption would change due to changes in the market price of oil given the current pattern of demand and subsidies. Further, many countries, especially in the developed countries/regions (*i.e.*, the European Union), already have or anticipate implementing policies to limit GHG emissions. Further out in the future, it is anticipated that developing countries would take actions to reduce their GHG emissions as well. Any increases in petroleum consumption and GHG emissions in other nations that occur in response to a decline in world petroleum prices would be attributed to those nations, and recorded in their respective GHG emissions inventories. Thus, including the same increase in emissions as part of the impact of adopting CAFE standards in the U.S. would risk double-counting of global emissions totals. NHTSA seeks comment on how to estimate the international “take back” effect and its impact on fuel consumption and GHG emissions. See the Energy Security section of the TSD, 4.2.8, for more discussion of the impact of the proposed vehicle rule on oil markets.

On-Road Fuel Economy Adjustment

Actual fuel economy levels achieved by vehicles in on-road driving fall significantly short of their levels measured under the laboratory-like test conditions used by EPA to establish its published fuel economy ratings for different models. In analyzing the fuel savings from alternative passenger car and light truck CAFE standards, the agency adjusts the actual fuel economy performance of each passenger car and light truck model downward from its rated value to reflect the expected size of this on-road fuel economy “gap.” In December 2006, EPA adopted changes to its regulations on fuel economy labeling, which were intended to bring vehicles’ rated fuel economy levels closer to their actual on-road fuel economy levels.²⁰⁹

²⁰⁷ Over the long run, consumers can alter their choice of vehicle (and thus the fuel economy they achieve), in addition to altering their number of miles driven.

²⁰⁸ The long-run price elasticity of demand for gasoline is in the 0.6 to 0.8 range.

²⁰⁹ EPA, Fuel Economy Labeling of Motor Vehicles: Revisions To Improve Calculation of Fuel Economy Estimates; Final Rule, 40 CFR Parts 86 and 600, Federal Register, December 27, 2006, pp. 77872-77969, <http://www.epa.gov/fedrgstr/EPA-AIR/2006/December/Day-27/a9749.pdf>.

Supplemental analysis reported by EPA as part of its Final Rule indicates that actual on-road fuel economy for light-duty vehicles averages 20 percent lower than published fuel economy levels.²¹⁰ For example, if the overall EPA fuel economy rating of a light truck is 20 mpg, the on-road fuel economy actually achieved by a typical driver of that vehicle is expected to be 16 mpg (20*.80). The agency has employed EPA's revised estimate of this on-road fuel economy gap in its analysis of the fuel savings resulting from alternative CAFE standards for MY 2011-2016 passenger cars and light trucks.

An analysis conducted by NHTSA confirmed that EPA's estimate of a 20 percent gap between test and on-road fuel economy is well-founded. The agency used data on the number of passenger cars and light trucks of each model year that were in service (registered for use) during each calendar year from 2000 through 2006, average fuel economy for passenger cars and light trucks produced during each model year, and estimates of average miles driven per year by cars and light trucks of different ages during each calendar year over that period. These data were combined to develop estimates of the usage-weighted average fuel economy that the U.S. passenger car and light truck fleets would have achieved during each year from 2000 through 2006 under test conditions.

Table VIII-4 compares the agency's estimates of fleet-wide average fuel economy under test conditions for 2000 through 2006 to the Federal Highway Administration's (FHWA) published estimates of the estimates of actual on-road fuel economy achieved by passenger cars and light trucks during each of those years. As it shows, FHWA's estimates of actual fuel economy for passenger cars ranged from 21 percent to 23 percent lower than NHTSA's estimates of its fleet-wide average value under test conditions over this period. Similarly, FHWA's estimates of actual fuel economy for light trucks ranged from 16 percent to 18 percent lower than NHTSA's estimates of average light truck fuel economy under test conditions. These results appear to confirm that the 20% on-road fuel economy discount or gap represents a reasonable estimate for use in evaluating the fuel savings likely to result from alternative CAFE standards for MY 2012-2016 vehicles.

Table VIII-4
Estimated Fleet-Wide Fuel Economy of Passenger Cars and Light Trucks Compared to Reported Fuel Economy

²¹⁰ EPA, *Final Technical Support Document: Fuel Economy Labeling of Motor Vehicle Revisions to Improve Calculation of Fuel Economy Estimates*, Office of Transportation and Air Quality EPA420-R-06-017 December 2006, Chapter II, <http://www.epa.gov/fueleconomy/420r06017.pdf>.

Calendar Year	Passenger Cars			Light-Dutry Trucks		
	NHTSA Estimated Test MPG	FHWA Reported Actual MPG	Percent Difference	NHTSA Estimated Test MPG	FHWA Reported Actual MPG	Percent Difference
2000	28.2	21.9	-22.2%	20.8	17.4	-16.3%
2001	28.2	22.1	-21.7%	20.8	17.6	-15.5%
2002	28.3	22.0	-22.3%	20.9	17.5	-16.2%
2003	28.4	22.2	-21.9%	21.0	17.2	-18.0%
2004	28.5	22.5	-21.1%	21.0	17.2	-18.3%
2005	28.6	22.1	-22.8%	21.1	17.7	-16.3%
2006	28.8	22.5	-21.8%	21.2	17.8	-16.2%
Average, 2000-2006	28.4	22.2	-22.0%	21.0	17.5	-16.7%

A. Benefits to Vehicle Buyers from Improving Fuel Economy

The main source of economic benefits from raising CAFE standards is the value of the resulting fuel savings over the lifetimes of vehicles that are required to achieve higher fuel economy. The annual fuel savings under each alternative CAFE standard are measured by the difference between total annual fuel consumption by passenger cars or light trucks with the fuel economy they are expected to achieve in on-road driving under that alternative standard, and their annual fuel consumption with the fuel economy levels – again adjusted for differences between test and actual on-road driving conditions – they would achieve under the baseline alternative. The sum of these annual fuel savings over each calendar year that cars or light trucks produced during a model year are expected to remain in service represents their cumulative lifetime fuel savings with that alternative CAFE standard in effect.

Vehicle Survival Rates

These annual fuel savings depend on the number of vehicles that remain in use during each year of a model year's lifetimes. The number of passenger cars or light trucks manufactured during a model year that remains in service during each subsequent calendar year is estimated by multiplying the original number expected to be produced during that model year by the proportion of vehicles expected to remain in service to the age they will have reached during that year. The proportions of passenger cars and light trucks expected to remain in service at each age up to their maximum lifetimes (26 and 36 years, respectively) are shown in Tables VIII-5a and VIII-5b.²¹¹ These "survival rates," which are estimated from experience with recent model-year vehicles, are slightly different than the survival rates used in past NHTSA analyses, since they reflect recent increases in durability and usage of more recent passenger car and light truck models.²¹²

²¹¹ The maximum age of cars and light trucks was defined as the age when the number remaining in service has declined to approximately two percent of those originally produced. Based on an examination of recent registration data for previous model years, typical maximum ages appear to be 26 years for passenger cars and 36 years for light trucks.

²¹² The survival rates were calculated from R.L. Polk, National Vehicle Population Profile (NVPP), 1977-2003; see NHTSA, "Vehicle Survival and Travel Mileage Schedules," Office of Regulatory Analysis and Evaluation, NCSA,

Vehicle Use

Annual fuel savings during each year of a model year's lifetime also depend on the number of miles that the remaining vehicles in use are driven. Updated estimates of average annual miles driven by age were developed by NHTSA from the Federal Highway Administration's 2001 National Household Transportation Survey, and these also differ from the estimates of annual mileage employed in past NHTSA analyses.²¹³ Table VIII-5a and VIII-5b also report NHTSA's updated estimates of average car and light truck use. The *total* number of miles driven by passenger cars or light trucks produced during a model year are driven during each year of its lifetime is estimated by multiplying these age-specific estimates of average car and light truck use by the number of vehicles projected to remain in service during that year.

As Tables VIII-5a and VIII-5b also show, the resulting survival-weighted mileage over the 26-year maximum lifetime of passenger cars is 161,847 miles, while that over the 36-year maximum lifetime of light trucks is 190,066 miles. Fuel savings and other benefits resulting from higher CAFE standards for passenger cars and light trucks are calculated over their respective lifetimes and total expected mileage. It should be noted, however, that survival-weighted mileage is extremely low (less than 1,000 miles per year) after age 20 for cars and after age 25 for light trucks, and thus has little impact on lifetime fuel savings or other benefits from higher fuel economy, particularly after discounting those benefits to their present values.

In interpreting the survival and annual mileage estimates reported in Tables VIII-5a and VIII-5b, it is important to understand that vehicles are considered to be of age 1 during the calendar year that coincides with their model year. Thus for example, model year 2012 vehicles will be considered to be of age 1 during calendar year 2012. This convention is used in order to account for the fact that vehicles produced during a model year typically are first offered for sale in June through September of the preceding calendar year (for example, sales of a model year typically begin in June through September of the previous calendar year, depending on manufacturer). Thus virtually all of the vehicles produced during a model year will be in use for some or all of the calendar year coinciding with their model year, and they are considered to be of age 1 during that year.²¹⁴

January 2006, pp. 9-11, Docket No. 22223-2218. Polk's NVPP is an annual census of passenger cars and light trucks registered for on-road operation in the United States as of Jul 1 each year. NVPP registration data from vehicle model years 1977 to 2003 were used to develop the survival rates reported in Tables VIII-5a and VIII-5b. Survival rates were averaged for the five most recent model years for vehicles up to 20 years old, and regression models were fitted to these data to develop smooth relationships between age and the proportion of cars or light trucks surviving to that age.

²¹³ See also NHTSA, "Vehicle Survival and Travel Mileage Schedules," Office of Regulatory Analysis and Evaluation, January 2006, pp. 15-17. The original source of information on annual use of passenger cars and light trucks by age used in this analysis is the 2001 National Household Travel Survey (NHTS), jointly sponsored by the Federal Highway Administration, Bureau of Transportation Statistics, and National Highway Traffic Safety Administration.

²¹⁴ As an illustration, virtually the entire production of model year 2012 cars and light trucks will have been sold by the end of calendar year 2012, so those vehicles are defined to be of age 1 during calendar year 2012. Model year 2012 vehicles are subsequently defined to be of age 2 during calendar year 2013, age 3 during calendar year 2014, and so on. One complication arises because registration data are typically collected for July 1 of each calendar year, so not all vehicles produced during a model year will appear in registration data until the calendar year when they have reached age 2 (and sometimes age 3) under this convention.

Table VIII-5a
Survival Rates and Unadjusted Annual Miles Traveled (VMT)
by Age for Passenger Cars

Vehicle Age	Estimated Survival Fraction	Estimated Annual VMT	Survival-Weighted Annual VMT
1	0.9950	14,231	14,160
2	0.9900	13,961	13,821
3	0.9831	13,669	13,438
4	0.9731	13,357	12,998
5	0.9593	13,028	12,497
6	0.9413	12,683	11,938
7	0.9188	12,325	11,324
8	0.8918	11,956	10,662
9	0.8604	11,578	9,961
10	0.8252	11,193	9,237
11	0.7866	10,804	8,499
12	0.7170	10,413	7,466
13	0.6125	10,022	6,138
14	0.5094	9,633	4,907
15	0.4142	9,249	3,831
16	0.3308	8,871	2,934
17	0.2604	8,502	2,214
18	0.2028	8,144	1,652
19	0.1565	7,799	1,220
20	0.1200	7,469	896
21	0.0916	7,157	656
22	0.0696	6,866	478
23	0.0527	6,596	348
24	0.0399	6,350	253
25	0.0301	6,131	185
26	0.0227	5,940	135
Estimated Passenger Car Lifetime VMT			161,847

Table VIII-5b
Survival Rates and Unadjusted Annual Vehicle-Miles Traveled (VMT)
by Age for Light Trucks

Vehicle Age	Estimated Survival Fraction	Estimated Annual VMT	Survival-Weighted Annual VMT
1	0.9950	16,085	16,004
2	0.9741	15,782	15,374
3	0.9603	15,442	14,829
4	0.9420	15,069	14,195
5	0.9190	14,667	13,479
6	0.8913	14,239	12,691
7	0.8590	13,790	11,845
8	0.8226	13,323	10,960
9	0.7827	12,844	10,053
10	0.7401	12,356	9,145
11	0.6956	11,863	8,252
12	0.6501	11,369	7,391
13	0.6042	10,879	6,573
14	0.5517	10,396	5,735
15	0.5009	9,924	4,971
16	0.4522	9,468	4,281
17	0.4062	9,032	3,669
18	0.3633	8,619	3,131
19	0.3236	8,234	2,665
20	0.2873	7,881	2,264
21	0.2542	7,565	1,923
22	0.2244	7,288	1,635
23	0.1975	7,055	1,393
24	0.1735	6,871	1,192
25	0.1522	6,739	1,026
26	0.1332	6,663	887
27	0.1165	6,648	774
28	0.1017	6,648	676
29	0.0887	6,648	590
30	0.0773	6,648	514
31	0.0673	6,648	447
32	0.0586	6,648	390
33	0.0509	6,648	338
34	0.0443	6,648	294
35	0.0385	6,648	256
36	0.0334	6,648	222
Estimated Lifetime Light Truck VMT			190,066

Adjusting Vehicle Use

The estimates of average annual miles driven by passenger cars and light trucks reported in Tables VIII-5a and VIII-5b reflect the historically low gasoline prices that prevailed at the time the 2001 National Household Travel Survey (NHTS) was conducted. To account for the effect on vehicle use of subsequent increases in fuel prices, the estimates of annual vehicle use derived from the NHTS were adjusted to reflect the forecasts of future gasoline prices reported in the *AEO 2009* Reference Case. This adjustment accounts for the difference between the average price per gallon of fuel forecast for each year over the expected lifetimes of model year 2012-2016 passenger cars and light trucks, and the average price that prevailed when the NHTS was conducted in 2001. The elasticity of annual vehicle use with respect to fuel cost per mile corresponding to the 10% fuel economy rebound effect used in this analysis (i.e., an elasticity of -0.10) was applied to the percent difference between each future year's fuel prices and those prevailing in 2001 to adjust the estimates of vehicle use derived from the NHTS to reflect the effect of higher future fuel prices.

The estimates of annual miles driven by passenger cars and light trucks at each age were also adjusted to reflect projected future growth in average vehicle use. Increases in the average number of miles cars and trucks are driven each year have been an important source of historical growth in *total* car and light truck use, and are expected to represent an important source of future growth in total light-duty vehicle travel as well. As an illustration of the importance of growth in average vehicle use, the total number of miles driven by passenger cars increased 35 percent from 1985 through 2005, equivalent to a compound annual growth rate of 1.5 percent.²¹⁵ During that time, however, the total number of passenger cars registered for in the U.S. grew by only about 0.3 percent annually.²¹⁶ Thus growth in the average number of miles automobiles are driven each year accounted for the remaining 1.2 percent (= 1.5 percent - 0.3 percent) annual growth in total automobile use.²¹⁷ Further, the AEO 2009 Reference Case forecasts of total car and light truck use and of the number of cars and light trucks in use suggest that their average annual use will continue to increase gradually from 2010 through 2030.

In order to develop reasonable estimates of future growth in average car and light truck use, NHTSA calculated the rate of growth in the mileage schedules shown in Tables VIII-5a and VIII-5b that would be necessary for total car and light truck travel to increase at the rate forecast in the *AEO 2009* Reference Case. This rate was calculated in a manner that is also consistent with future changes in the overall size and age distributions of the U.S. passenger car and light truck fleets that are implied by the agency's adjusted forecasts of total car and light truck sales reported previously in Tables VIII-1a and VIII-1b, together with the survival rates reported in Tables VIII-5a and VIII-5b. The growth rate in average annual car and light truck use produced by this calculation is approximately 1.1% per year.²¹⁸ This rate was applied to the mileage

²¹⁵ Calculated from data reported in FHWA, Highway Statistics, Summary to 1995, Table vm201at <http://www.fhwa.dot.gov/ohim/summary95/vm201a.xlw>, and annual editions 1996-2005, Table VM-1 at <http://www.fhwa.dot.gov/policy/ohpi/hss/hsspubs.htm> (last accessed April 20, 2008).

²¹⁶ A slight increase in the fraction of new passenger cars remaining in service beyond age 10 has accounted for a small share of growth in the U.S. automobile fleet. The fraction of new automobiles remaining in service to various ages was computed from R.L. Polk vehicle registration data for 1977 through 2005 by the agency's Center for Statistical Analysis.

²¹⁷ See *supra* note [2 above here]

²¹⁸ It was not possible to estimate separate growth rates in average annual use for cars and light trucks, because of the significant reclassification of light truck models as passenger cars discussed previously.

figures reported in Tables VIII-5a and VIII-5b to estimate annual mileage by age during each year of the expected lifetimes of MY 2012-2016 cars and light trucks.

Tables VIII-5c and VIII-5d report the results of applying the adjustments for both future fuel prices and annual growth in car and light truck use to the figures reported previously in Tables VIII-a and VIII-b. While the adjustment for future fuel prices reduces average mileage at each age from the values shown previously, the adjustment for expected future growth in average vehicle use increases it. As Tables VIII-5c and VIII-5d show, the net effect of these two adjustments is to increase expected lifetime mileage significantly; for passenger cars, this figure rises to 190,971 miles from the 161,847 miles reported previously in Table VIII-5a (or by 18%), while expected lifetime mileage for light trucks increases from the 190,066 miles reported previously in Table VIII-5b to 221,199 miles (16%). As previously, however, the estimates of survival-weighted mileage decline to less than 1,000 miles per year after age 20 for cars and after age 27 for light trucks. Thus they have relatively little impact on lifetime fuel savings or other benefits from higher fuel economy, particularly after discounting the benefits that occur in those distant future years to their present values.

Table VIII-5c
Survival Rates and Adjusted Annual Vehicle-Miles Traveled (VMT)
by Age for Passenger Cars

Vehicle Age	Estimated Survival Fraction	Estimated Annual VMT	Survival-Weighted Annual VMT
1	0.9950	16,932	16,847
2	0.9900	16,603	16,437
3	0.9831	16,257	15,983
4	0.9731	15,814	15,389
5	0.9593	15,414	14,787
6	0.9413	14,993	14,113
7	0.9188	14,545	13,364
8	0.8918	14,105	12,578
9	0.8604	13,624	11,722
10	0.8252	13,192	10,886
11	0.7866	12,668	9,964
12	0.7170	12,222	8,763
13	0.6125	11,705	7,170
14	0.5094	11,191	5,700
15	0.4142	10,727	4,443
16	0.3308	10,283	3,402
17	0.2604	9,878	2,572
18	0.2028	9,482	1,923
19	0.1565	9,090	1,423
20	0.1200	8,691	1,043
21	0.0916	8,366	766
22	0.0696	8,126	566
23	0.0527	8,003	422
24	0.0399	7,774	310
25	0.0301	7,587	228
26	0.0227	7,424	169
Adjusted Lifetime Passenger Car VMT			190,971

Table VIII-5d
Survival Rates and Adjusted Annual Vehicle-Miles Traveled (VMT)
by Age for Light Trucks

Vehicle Age	Estimated Survival Fraction	Estimated Annual VMT	Survival-Weighted Annual VMT
1	0.9950	18,847	18,752
2	0.9741	18,408	17,931
3	0.9603	18,050	17,333
4	0.9420	17,575	16,556
5	0.9190	17,142	15,753
6	0.8913	16,593	14,790
7	0.8590	16,095	13,826
8	0.8226	15,493	12,745
9	0.7827	14,891	11,655
10	0.7401	14,336	10,610
11	0.6956	13,689	9,522
12	0.6501	13,160	8,555
13	0.6042	12,554	7,585
14	0.5517	11,945	6,590
15	0.5009	11,342	5,681
16	0.4522	10,822	4,894
17	0.4062	10,383	4,218
18	0.3633	9,900	3,597
19	0.3236	9,433	3,053
20	0.2873	9,033	2,595
21	0.2542	8,692	2,210
22	0.2244	8,499	1,907
23	0.1975	8,246	1,629
24	0.1735	8,261	1,433
25	0.1522	8,066	1,228
26	0.1332	8,066	1,074
27	0.1165	8,101	944
28	0.1017	8,098	824
29	0.0887	8,096	718
30	0.0773	8,095	626
31	0.0673	8,093	545
32	0.0586	8,092	474
33	0.0509	8,086	412
34	0.0443	8,080	358
35	0.0385	8,064	310
36	0.0334	8,050	269
Adjusted Lifetime Light Truck VMT			221,199

Estimating Annual Fuel Consumption

NHTSA estimated annual fuel consumption during each year of the expected lifetimes of model year 2012-2016 cars and light trucks with alternative CAFE standards in effect by dividing the total number of miles that a model year's surviving vehicles are driven by the fuel economy that they are expected to achieve under each alternative standard.²¹⁹ Lifetime fuel consumption by each model year's cars and light trucks is the sum of the annual use by the vehicles produced during that model year that are projected to remain in service during each year of their expected lifetimes. In turn, the *savings* in lifetime fuel consumption by MY 2012-2016 cars and light trucks that would result from alternative increases in CAFE standards is the difference between their lifetime fuel use at the fuel economy level they are projected to attain under the Adjusted Baseline alternative, and their lifetime fuel use at the higher fuel economy level they are projected to achieve under each alternative standard.

NHTSA's analysis values the economic benefits to vehicle owners and to the U.S. economy that result from future fuel savings over the full expected lifetimes of MY 2012-2016 passenger cars and light trucks. This reflects the agency's assumption that while the purchasers of new vehicles might not realize the full lifetime benefits of improved fuel economy, subsequent owners of those vehicles will continue to experience the resulting fuel savings until they are retired from service. Of course, not all vehicles produced during a model year remain in service for the complete lifetimes (26 years for passenger cars or 36 years for light trucks) of each model year. Due to the pattern of vehicle retirements with increasing age, the expected or average lifetimes of typical representative cars and light trucks are approximately half of these figures.

Economic Benefits from Reduced Fuel Consumption

The economic value of fuel savings resulting from alternative CAFE standards is estimated by applying the Reference Case forecast of future fuel prices from the Energy Information Administration's *Annual Energy Outlook 2009* to each future year's estimated fuel savings. The *AEO 2009* Reference Case forecast of future fuel prices, which is reported in Table VIII-4, represents retail prices per gallon of fuel, including federal, state, and any applicable local taxes. While the retail price of fuel is the proper measure for valuing fuel savings from the perspective of *vehicle owners*, two adjustments to the retail prices are necessary in order to accurately reflect the economic value of fuel savings to *the U.S. economy*.

First, federal, state, and local taxes are excluded from the social value of fuel savings because these do not reflect costs of resources used in fuel production, and thus do not reflect resource savings that would result from reducing fuel consumption. Instead, fuel taxes simply represent resources that are transferred from purchasers of fuel to road and highway users, since fuel taxes primarily fund construction and maintenance of those facilities. Any reduction in State and Federal fuel tax payments by fuel purchasers will reduce government revenues by the same amount, thus ultimately reducing the value of government-financed services by approximately that same amount. The benefit derived from lower taxes to individuals is thus likely to be offset exactly by a reduction in the value of services funded using those tax revenues.

²¹⁹ The total number of miles that vehicles are driven each year is slightly different under each alternative as a result of the fuel economy "rebound effect," which is discussed in detail elsewhere in this chapter.

Second, the economic cost of externalities generated by U.S. consumption and imports of petroleum products will be reduced in proportion to fuel savings resulting from higher CAFE standards. The estimated economic value of these externalities, which is discussed in detail in the subsequent section of this Chapter, is converted into its per-gallon equivalent and added to the pre-tax price of gasoline in order to measure this additional benefit to society for each gallon of fuel saved. This also allows the magnitude of these externalities to be easily compared to the value of the resources saved by reducing fuel production and use, which represents the most important component of the social benefits from saving gasoline.

Table VIII-6 illustrates the adjustment of forecast retail fuel prices to remove the value of fuel taxes and add the value of economic externalities from petroleum imports and use. While the Reference Case fuel price forecasts reported in *AEO 2009* extend through 2030, the agency's analysis of the value of fuel savings over the lifetimes of MY 2012-2016 cars and light trucks requires forecasts extending through calendar year 2050. The agency assumes that retail fuel prices will continue to increase after 2030 at the average rates reported in the *AEO 2009* Reference Case forecast over the period from 2020 through 2030 (in constant-dollar terms).²²⁰ As Table VIII-6 shows, the projected retail price of gasoline expressed in 2007 dollars rises steadily over the forecast period, from \$2.50 in 2011 to \$4.25 in 2050.

The agency has updated its estimates of gasoline taxes, using updated state tax rates reported for January 1, 2006²²¹ Expressed in 2007 dollars, federal gasoline taxes are currently \$0.184, while state and local gasoline taxes together average \$0.236 per gallon, for a total tax burden of \$0.420 per gallon. Following the assumptions used by EIA in *AEO 2009*, state and local gasoline taxes are assumed to keep pace with inflation in nominal terms, and thus to remain constant when expressed in constant 2007 dollars. In contrast, EIA assumes that federal gasoline taxes will remain unchanged in *nominal* terms, and thus decline throughout the forecast period when expressed in constant 2007 dollars. These differing assumptions about the likely future behavior of federal and state/local fuel taxes are consistent with recent historical experience, which reflects the fact that federal motor fuel taxes as well as most state fuel taxes are specified on a cents-per-gallon basis (some State taxes are levied as a percentage of the wholesale price of fuel), and typically require legislation to change.

Projected future fuel prices are a critical input into the preliminary economic analysis of alternative standards, because they determine the value of fuel savings both to new vehicle buyers and to society. The agencies relied on the most recent fuel price projections from the U.S. Energy Information Administration's (EIA) Annual Energy Outlook (AEO) for this analysis. Specifically, the agencies used the AEO 2009 (April 2009 release) Reference Case forecasts of inflation-adjusted (constant-dollar) retail gasoline and diesel fuel prices, which

²²⁰ This projection uses the rate of increase in fuel prices for 2020-2030 rather than that over the complete forecast period (2009-2030) because there is extreme volatility in the forecasts for the years 2009 through approximately 2020. Using the average rate of change over the complete 2009-2030 forecast period would result in projections of declining fuel prices after 2030.

²²¹ FHWA, *Highway Statistics 2006*, Section I: Motor Fuel -- Rates and Revenues, Table MF-121T, available at <http://www.fhwa.dot.gov/policy/ohim/hs06/pdf/mf121t.pdf>.

represent the EIA's most up-to-date estimate of the most likely course of future prices for petroleum products.²²²

EIA's Updated Reference Case reflects the effects of the American Reinvestment and Recovery Act of 2009, as well as the most recent revisions to the U.S. and global economic outlook. In addition, it also reflects the provisions of the Energy Independence and Security Act of 2007 (EISA), including the requirement that the combined mpg level of U.S. cars and light trucks reach 35 miles per gallon by model year 2020. Because this provision would be expected to reduce future U.S. demand for gasoline and other fuels, there is some concern about whether the AEO 2009 forecast of fuel prices already partly reflects the increases in CAFE standards considered in this rule, and thus whether it is suitable for valuing the projected reductions in fuel use. In response to this concern, the agencies note that EIA issued a revised version of AEO 2008 in June 2008, which modified its previous December 2007 Early Release of AEO 2008 to reflect the effects of the recently-passed EISA legislation.²²³ The fuel price forecasts reported in EIA's Revised Release of AEO 2008 differed by less than one cent per gallon over the entire forecast period (2008-230) from those previously issued as part of its initial release of AEO 2008. Thus, the agencies are reasonably confident that the fuel price forecasts presented in AEO 2009 and used to analyze the value of fuel savings projected to result from this rule are not unduly affected by the CAFE provisions of EISA. Nevertheless, the agencies request comment on the use of the AEO 2009 fuel price forecasts, and particularly on the potential impact of the EISA-mandated CAFE improvements on these projections.

Table VIII-6
Adjustment of Forecast Retail Gasoline Prices
to Reflect the Economic Value of Fuel Savings

Year	AEO 2009 Revised Forecast of Retail Gasoline Price (2007 \$/gallon)	Estimated Federal and State Taxes (2007 \$/gallon)	Forecast Gasoline Price Excluding Taxes (2007 \$/gallon)	Forecast Gasoline Price Including Externalities (2007 \$/gallon)
2011	\$2.50	\$0.43	\$2.07	\$2.24
2012	\$2.70	\$0.43	\$2.27	\$2.44
2013	\$2.85	\$0.42	\$2.42	\$2.59
2014	\$3.00	\$0.42	\$2.58	\$2.75
2015	\$3.16	\$0.42	\$2.75	\$2.92

²²² Energy Information Administration, Annual Energy Outlook 2009, Revised Updated Reference Case (April 2009), Table 12. Available at http://www.eia.doe.gov/oiaf/servicerpt/stimulus/excel/aeostimtab_12.xls (last accessed July 26, 2009).

²²³ Energy Information Administration, Annual Energy Outlook 2008, Revised Early Release (June 2008), Table 12. Available at http://www.eia.doe.gov/oiaf/archive/aeo08/excel/aeotab_12.xls (last accessed September 12, 2009).

2016	\$3.27	\$0.41	\$2.86	\$3.03
2017	\$3.39	\$0.41	\$2.98	\$3.15
2018	\$3.48	\$0.41	\$3.08	\$3.25
2019	\$3.56	\$0.40	\$3.16	\$3.33
2020	\$3.62	\$0.40	\$3.22	\$3.39
2021	\$3.64	\$0.39	\$3.24	\$3.41
2022	\$3.67	\$0.39	\$3.28	\$3.45
2023	\$3.69	\$0.39	\$3.30	\$3.47
2024	\$3.69	\$0.38	\$3.31	\$3.48
2025	\$3.68	\$0.38	\$3.30	\$3.47
2026	\$3.72	\$0.38	\$3.34	\$3.51
2027	\$3.72	\$0.38	\$3.34	\$3.51
2028	\$3.76	\$0.37	\$3.39	\$3.56
2029	\$3.87	\$0.37	\$3.50	\$3.66
2030	\$3.82	\$0.37	\$3.45	\$3.62
2031	\$3.84	\$0.37	\$3.47	\$3.64
2032	\$3.86	\$0.36	\$3.50	\$3.67
2033	\$3.88	\$0.36	\$3.52	\$3.69
2034	\$3.90	\$0.36	\$3.54	\$3.71
2035	\$3.92	\$0.36	\$3.57	\$3.74
2036	\$3.95	\$0.36	\$3.59	\$3.76
2037	\$3.97	\$0.35	\$3.61	\$3.78
2038	\$3.99	\$0.35	\$3.64	\$3.81
2039	\$4.01	\$0.35	\$3.66	\$3.83
2040	\$4.03	\$0.35	\$3.68	\$3.85
2041	\$4.05	\$0.35	\$3.71	\$3.88
2042	\$4.07	\$0.34	\$3.73	\$3.90
2043	\$4.10	\$0.34	\$3.76	\$3.92
2044	\$4.12	\$0.34	\$3.78	\$3.95
2045	\$4.14	\$0.34	\$3.80	\$3.97
2046	\$4.16	\$0.34	\$3.83	\$4.00
2047	\$4.19	\$0.33	\$3.85	\$4.02
2048	\$4.21	\$0.33	\$3.88	\$4.04
2049	\$4.23	\$0.33	\$3.90	\$4.07
2050	\$4.25	\$0.33	\$3.92	\$4.09

Benefits from Additional Driving

The increase in travel associated with the rebound effect produces additional benefits to vehicle owners, which reflect the value to drivers and other vehicle occupants of the added (or more desirable) social and economic opportunities that become accessible with additional travel. As evidenced by the fact that they elect to make more frequent or longer trips when the cost of

driving declines, the benefits from this added travel exceed drivers' added outlays for the fuel it consumes (measured at the improved level of fuel economy resulting from stricter CAFE standards).²²⁴ The amount by which the benefits from this increased driving travel exceed its increased fuel costs measures the net benefits they receive from the additional travel, usually are referred to as increased consumer surplus.

NHTSA's analysis estimates the economic value of the increased consumer surplus provided by added driving using the conventional approximation, which is one half of the product of the decline in vehicle operating costs per vehicle-mile and the resulting increase in the annual number of miles driven. Because it depends on the extent of improvement in fuel economy, the value of benefits from increased vehicle use changes by model year and varies among alternative CAFE standards. Under even those alternatives that would impose the highest standards, however, the magnitude of benefits from additional vehicle use represents a small fraction of the total benefits from requiring cars and light trucks to achieve higher fuel economy.

The Value of Increased Driving Range

Improving the fuel economy of passenger cars and light-duty trucks may also increase their driving range before they require refueling. By reducing the frequency with which drivers typically refuel their vehicles and extending the upper limit of the range they can travel before requiring refueling, improving fuel economy thus provides some additional benefits to their owners. Alternatively, if manufacturers respond to improved fuel economy by reducing the size of fuel tanks to maintain a constant driving range, the resulting cost saving will presumably be reflected in lower vehicle sales prices. If manufacturers respond by doing so, this presumably reflects their judgment that the value to economic benefits to vehicle buyers from lower purchase prices exceeds that from extended refueling range.

No direct estimates of the value of extended vehicle range are readily available, so the agencies' analyses calculate the reduction in the annual number of required refueling cycles that results from improved fuel economy, and applies DOT-recommended values of travel time savings to convert the resulting time savings to their economic value.²²⁵ As a coarse illustration of how the value of extended refueling range is estimated, a typical small light truck model has an average fuel tank size of approximately 20 gallons.²²⁶ Based on a California Air Resources Board Study, the average fuel purchase is approximately 55% of tank volume.²²⁷ Therefore, increasing this model's actual on-road fuel economy from 24 to 25 mpg would extend its driving range from 216 miles (= 9 gallons x 24 mpg) to 225 miles (= 9 gallons x 25 mpg). Assuming that this vehicle is driven 12,000 miles/year, this reduces the number of times it needs to be refueled each year from 55.5 (= 12,000 miles per year / 216 miles per refueling) to 53.3 (= 12,000 miles per year / 225 miles per refueling), or by 2.2 refuelings per year.

²²⁴ These benefits are included in the value of fuel savings reported in Tables VIII-5 through VIII-9.

²²⁵ Department of Transportation, Guidance Memorandum, "The Value of Saving Travel Time: Departmental Guidance for Conducting Economic Evaluations," Apr. 9, 1997.

<http://ostpxweb.dot.gov/policy/Data/VOT97guid.pdf> (last accessed October 20, 2007); update *available at* http://ostpxweb.dot.gov/policy/Data/VOTrevision1_2-11-03.pdf (last accessed October 20, 2007).

²²⁶ Based on the Volpe Model Market Data file for Model Year 2011, average tank volumes for cars and trucks are 16.6 gallons and 23.0 gallons, respectively. This produces a production weighted average of 19.3 gallons.

²²⁷ California Environmental Protection Agency, Air Resources Board. Draft Assessment of the Real-World Impacts of Commingling California Phase 3 Reformulated Gasoline. August 2003

Weighted by the nationwide mix of urban (about 2/3) and rural (about 1/3) driving and average vehicle occupancy for all driving trips (1.6 persons), the DOT-recommended value of travel time per vehicle-hour is \$24.00 (in 2006 dollars).²²⁸ Assuming that locating a station and filling up requires five minutes, the annual value of time saved as a result of less frequent refueling amounts to \$4.40 (calculated as $5/60 \times 2.2 \times \$24.00$). This calculation is repeated for each future calendar year that light trucks of each model year affected by the alternative fuel economy standards considered in this rule would remain in service. Like fuel savings and other benefits, however, the value of this benefit declines over a model year's lifetime, because a smaller number of vehicles originally produced during that model year remain in service each year, and those remaining in service are driven fewer miles.

The agencies' estimate of benefits from less frequent refueling is subject to several sources of uncertainty.

First, it assumes that manufacturers will not adjust fuel tank capacities downward (from the current average of 19.3 gallons) when they improve the fuel economy of their vehicle models, so that the entire increase in fuel economy will be reflected in increased driving range. Should manufacturers choose to downsize fuel tanks, and all other factors have been estimated with no error, the current estimates of refueling benefits would be overstated. On the other hand, vehicle space, utility and value could increase and vehicle weight will decrease, improving fuel economy and CO₂ emissions (all other things being equal). In the context of the rule, this will decrease the cost of compliance with the proposed standards.

Second, the agencies' analysis assumes that fuel purchases average 55% of fuel tank capacity. However, as shown in the California Air Resource Board (CARB) report, refueling patterns vary. Moreover, the 55% estimate implies that drivers, on average, are either refueling when nearly a half tank of gas remains in their vehicles, or that they are habitually not filling their tanks. Since many drivers only refuel when their tanks are very low, and since many drivers habitually fill up their tanks, this in turn implies that many drivers in the CARB study are refueling when their tanks are still well above 50% full. Certainly instances of this type of behavior occur, but the CARB study implies that it is the norm. Behavior that maximizes the number of fill-ups implies a very low value of time, but it is also possible that the results of the CARB study are not representative of typical behavior across the country. While based on field data, this estimate may thus overestimate the impact of refueling benefits.

Third, the agencies' estimate of refueling benefits assumes that refueling stops involve the same number of vehicle occupants as the overall average for all vehicle trips (1.6 persons). To the extent that drivers refuel while doing other errands or in advance of picking up passengers, this figure may overestimate the typical vehicle occupancy during refueling, and thus the total savings in refueling time. Similarly, the hourly value used to estimate the economic value of savings in refueling time reflects the typical mix of personal and business travel purposes, and drivers are likely to assign different values to their time when traveling for these different purposes. To the extent that drivers seek to refuel when traveling for purposes that

²²⁸ The hourly wage rate during 2006 is estimated to be \$24.00. Personal travel (94.4% of urban travel) is valued at 50 percent of the hourly wage rate. Business travel (5.6% of urban travel) is valued at 100 percent of the hourly wage rate. For intercity travel, personal travel (87%) is valued at 70 percent of the wage rate, while business travel (13%) is valued at 100 percent of the wage rate. The resulting values of travel time are \$12.67 for urban travel and \$17.66 for intercity travel, and must be multiplied by vehicle occupancy (1.6) to obtain the estimated value of time per vehicle hour.

typically use less valuable time, the hourly value used in the agencies' analysis may overstate the benefits from saving refueling time.

Finally, the agencies assume that both finding and using a refueling station takes, on average, five minutes. There are few, if any, data sources on average refueling time, and this estimate is subject to significant uncertainty.

For these reasons, the agencies' estimate of savings in refueling time is uncertain. The agencies seek comment or data on each of the assumptions they use to estimate this benefit, including alternative empirical estimates of the parameters used in its calculations.

C. Other Economic Benefits from Reducing U.S. Petroleum Use

Reducing fuel use by requiring cars and light trucks to attain higher fuel economy also produces wider benefits to the U.S. economy by lowering the cost of economic externalities that result from U.S. petroleum consumption and imports, including reducing the price of petroleum, lowering the potential costs from disruption in the flow of oil imports, and possibly reducing outlays to support U.S. military activities to secure the flow of oil imports and to cushion the economy against their possible interruption by maintaining the Strategic Petroleum Reserve. Reducing fuel consumption also lowers the economic costs of environmental externalities resulting from fuel production and use, including reducing the impacts on human health impacts from emissions of criteria air pollutants, and reducing future economic damages from potential changes in the global climate caused by greenhouse gas emissions.

Economic Externalities from U.S. Petroleum Imports

U.S. consumption and imports of petroleum products imposes costs on the domestic economy that are not reflected in the market price for crude petroleum, or in the prices paid by consumers of petroleum products such as gasoline. These costs include (1) higher prices for petroleum products resulting from the effect of U.S. oil import demand on the world oil price; (2) the risk of disruptions to the U.S. economy caused by sudden reductions in the supply of imported oil to the U.S.; and (3) expenses for maintaining a U.S. military presence to secure imported oil supplies from unstable regions, and for maintaining the strategic petroleum reserve (SPR) to cushion against resulting price increases.²²⁹

Higher U.S. consumption and imports of crude oil or refined petroleum products can raise the magnitude of these external economic costs, thus increasing the true economic cost of supplying transportation fuels above the resource costs of producing them. Conversely, *reducing* fuel consumption by requiring motor vehicles to achieve higher fuel economy will lower U.S. consumption and imports of crude petroleum and refined fuels, thus lowering the values of these external costs. Any reduction in their value that results from requiring improved vehicle fuel

²²⁹ See, e.g., Bohi, Douglas R. and W. David Montgomery (1982). *Oil Prices, Energy Security, and Import Policy* Washington, DC: Resources for the Future, Johns Hopkins University Press; Bohi, D. R., and M. A. Toman (1993). "Energy and Security: Externalities and Policies," *Energy Policy* 21:1093-1109; and Toman, M. A. (1993). "The Economics of Energy Security: Theory, Evidence, Policy," in A. V. Kneese and J. L. Sweeney, eds. (1993). *Handbook of Natural Resource and Energy Economics*, Vol. III. Amsterdam: North-Holland, pp. 1167-1218.

economy represents an additional economic benefit of raising CAFE standards, over and above the economic value of saving fuel itself.

Increased U.S. petroleum consumption can impose higher costs on all purchasers of petroleum products, because the U.S. is a sufficiently large purchaser of foreign oil supplies that changes in U.S. demand can affect the world petroleum price. The effect of U.S. petroleum demand on world oil prices is determined by the degree of OPEC monopoly power over global oil supplies, and the degree of monopsony power over world oil demand that the U.S. exercises. The importance of these two factors means that increases in domestic demand for petroleum products that are met through higher oil imports can cause the price of oil in the world market to rise, which imposes economic costs on all other purchasers in the global petroleum market in excess of the higher prices paid by U.S. consumers.²³⁰ Conversely, reducing U.S. oil imports can lower the world petroleum price, and thus generate benefits to other oil purchasers by reducing these “monopsony costs.”

Although the degree of current OPEC monopoly power is subject to considerable debate, the consensus appears to be that OPEC remains able to exercise some degree of control over the response of world oil supplies to variation in world oil prices, so that the world oil market does not behave competitively.²³¹ The extent of U.S. monopsony power is determined by a complex set of factors including the relative importance of U.S. imports in the world oil market, and the sensitivity of petroleum supply and demand to its world price among other participants in the international oil market. Most evidence appears to suggest that variation in U.S. demand for imported petroleum continues to exert some influence on world oil prices, although this influence appears to be limited.²³²

In analyzing benefits from its recent actions to increase light truck CAFE standards for model years 2005-07 and 2008-11, NHTSA relied on a 1997 study by Oak Ridge National Laboratories (ORNL) to estimate the value of reduced economic externalities from petroleum consumption and imports.²³³ More recently, ORNL updated its estimates of the value of these externalities, using the analytic framework developed in its original 1997 study in conjunction with recent

²³⁰ For example, if the U.S. imports 10 million barrels of petroleum per day at a world oil price of \$80 per barrel, its total daily import bill is \$800 million. If increasing imports to 11 million barrels per day causes the world oil price to rise to \$81 per barrel, the daily U.S. import bill rises to \$891 million. The resulting increase of \$91 million per day (\$891 million minus \$800 million) is attributable to increasing daily imports by only 1 million barrels. This means that the incremental cost of importing each additional barrel is \$91, or \$10 more than the newly-increased world price of \$81 per barrel. This additional \$10 per barrel represents a cost imposed on all other purchasers in the global petroleum market by U.S. buyers, in excess of the price they pay to obtain those additional imports.

²³¹ For a summary see Leiby, Paul N., Donald W. Jones, T. Randall Curlee, and Russell Lee, *Oil Imports: An Assessment of Benefits and Costs*, ORNL-6851, Oak Ridge National Laboratory, November 1, 1997, at 17. Available at http://dmses.dot.gov/docimages/pdf93/343894_web.pdf (last accessed Dec. 2, 2007).

²³² *Id.*, at 18-19.

²³³ Leiby, Paul N., Donald W. Jones, T. Randall Curlee, and Russell Lee, *Oil Imports: An Assessment of Benefits and Costs*, ORNL-6851, Oak Ridge National Laboratory, November 1, 1997. Available at http://dmses.dot.gov/docimages/pdf93/343894_web.pdf (last accessed Dec. 2, 2007).

estimates of the variables and parameters that determine their value.²³⁴ These include world oil prices, current and anticipated future levels of OPEC petroleum production, U.S. oil import levels, the estimated responsiveness of regional oil supplies and demands to prices in different regions of the world, and the likelihood of oil supply disruptions. ORNL's prepared its updated estimates of oil import externalities were for use by EPA in evaluating the benefits of reductions in U.S. oil consumption and imports expected to result from its recently-issued Renewable Fuel Standard Rule of 2007 (RFS)²³⁵.

The updated ORNL study was subjected to a detailed peer review, and its estimates of the value of oil import externalities were subsequently revised to reflect their comments and recommendations.²³⁶ Specifically, reviewers recommended that ORNL increase its estimates of the sensitivity of oil supply by non-OPEC producers and oil demand by nations other than the U.S. to changes in the world oil price, as well as reduce its estimate of the sensitivity of U.S. gross domestic product (GDP) to potential sudden increases in world oil prices. These revisions significantly changed ORNL's estimates of some components of the external costs of U.S. petroleum imports.

At the request of EPA, ORNL further revised its 2008 estimates of external costs from U.S. oil imports to reflect recent changes in the outlook for world petroleum prices and continuing changes in the structure and characteristics of global petroleum supply and demand. These most recent revisions increase ORNL's estimates of the monopsony cost associated with U.S. oil imports to \$4.52 to 22.65 per barrel, with a most likely estimate of \$12.50 per barrel of petroleum imported into the U.S. (expressed in 2007\$). These estimates imply that each gallon of fuel saved as a result of adopting higher CAFE standards that is reflected in lower U.S. imports of crude petroleum (or, presumably, refined products) will reduce the monopsony costs imposed by U.S. oil imports by \$0.108 to \$0.539 per gallon, with the actual value most likely to be \$0.298 per gallon saved (again in 2007\$).

These figures represent the reduced value of payments from U.S. oil purchasers to foreign oil suppliers that results when lower U.S. oil demand reduces the world price of petroleum, beyond the savings from reduced purchases of petroleum itself.²³⁷ Consistency with NHTSA's use of estimates of the *global* benefits from reducing emissions of CO₂ and other greenhouse gases in this analysis, however, requires the use of a global perspective for assessing their net value. From this perspective, reducing these payments simply results in a transfer of resources from foreign oil suppliers to U.S. purchasers (or more properly, in a savings in the value of resources previously transferred from U.S. purchasers to foreign producers), and provides no real savings in resources to the global economy. Thus NHTSA's analysis of the benefits from adopting higher CAFE standards for MY 2012-2016 cars and light trucks *excludes* the reduced value of

²³⁴ Leiby, Paul N. "Estimating the Energy Security Benefits of Reduced U.S. Oil Imports," Oak Ridge National Laboratory, ORNL/TM-2007/028, Revised July 23, 2007. Available at <http://pzl1.ed.ornl.gov/energysecurity.html> (click on link below "Oil Imports Costs and Benefits") (last accessed Sept. 10, 2007).

²³⁵ Federal Register Vol.72, #83, May 1, 2007 pp.23,900-24,014

²³⁶ *Peer Review Report Summary: Estimating the Energy Security Benefits of Reduced U.S. Oil Imports*, ICF, Inc., September 2007.

²³⁷ The reduction in payments from U.S. oil purchasers to domestic petroleum producers is not included as a benefit, since it represents a transfer that occurs entirely within the U.S. economy.

monopsony payments by U.S. oil consumers that might result from lower fuel consumption by these vehicles.

However, the agency invites comments on whether it may still be appropriate to use the monopsony benefit in conjunction with the global value for reducing emissions of greenhouse gases when calculating net benefits for the proposed rule. One perspective is that the global SCC is used in these calculations not because the agencies are attempting to estimate the global net benefits of the rule, but because in the context of estimating the optimal level of a global public good to provide, the global marginal benefit is the correct value benefit against which domestic costs are to be compared. In contrast, the value of improving the nation's energy security is *inherently* a domestic benefit. Thus NHTSA seeks comment on whether when both benefits are viewed from this domestic perspective, it is appropriate to include both in the net benefits estimates for this rulemaking, and more generally on the overall implications of this approach to justifying regulation.

The second component of external economic costs imposed by U.S. petroleum imports arises partly because an increase in oil prices triggered by a disruption in the supply of imported oil reduces the level of output that the U.S. economy can produce. The reduction in potential U.S. economic output depends on the extent and duration of the increases in petroleum product prices that result from a disruption in the supply of imported oil, as well as on whether and how rapidly these prices return to pre-disruption levels. Even if prices for imported oil return completely to their original levels, however, economic output will be at least temporarily reduced from the level that would have been possible without a disruption in oil supplies.

Because supply disruptions and resulting price increases tend to occur suddenly rather than gradually, they can also impose costs on businesses and households for adjusting their use of petroleum products more rapidly than if the same price increase had occurred gradually over time. These adjustments impose costs because they temporarily reduce economic output even below the level that would ultimately be reached once the U.S. economy completely adapted to higher petroleum prices. The additional costs to businesses and households reflect their inability to adjust prices, output levels, and their use of energy and other resources quickly and smoothly in response to rapid changes in prices for petroleum products.

Since future disruptions in foreign oil supplies are an uncertain prospect, each of these disruption costs must be adjusted by the probability that the supply of imported oil to the U.S. will actually be disrupted. The "expected value" of these costs – the product of the probability that an oil import disruption will occur and the costs of reduced economic output and abrupt adjustment to sharply higher petroleum prices – is the appropriate measure of their magnitude. Any reduction in the expected value of these costs resulting from a measure that lowers U.S. oil imports represents an additional benefit to the U.S. economy *beyond* the direct value of savings from reduced purchases of petroleum products.

While the vulnerability of the U.S. economy to oil price shocks is widely believed to depend on *total* petroleum consumption rather than on the level of oil imports, variation in imports is still likely to have some effect on the magnitude of price increases resulting from a disruption of import supply. In addition, changing the quantity of petroleum imported into the U.S. may also

affect the probability that such a disruption will occur. If either the size of the likely price increase or the probability that U.S. oil supplies will be disrupted is affected by oil imports, the expected value of the economic costs resulting from potential supply disruptions will also depend on the level of imports.

Businesses and households use a variety of market mechanisms, including oil futures markets, energy conservation measures, and technologies that permit rapid fuel switching to “insure” against higher petroleum prices and reduce their costs for adjusting to sudden price increases. While the availability of these market mechanisms has probably reduced the potential costs of disruptions to the supply of imported oil over time, consumers of petroleum products are unlikely to take account of costs they impose on others, so these costs are probably not fully reflected in the price of imported oil. Thus changes in oil import levels probably continue to affect the expected cost to the U.S. economy from potential oil supply disruptions, although this component of oil import costs is likely to be significantly smaller than estimated by studies conducted in the wake of the oil supply disruptions that occurred during the 1970s.

ORNL’s most recently updated and revised estimates of the increase in the expected costs associated with oil supply disruptions to the U.S. and the resulting rapid increase in prices for petroleum products amount to \$3.30 to \$11.31 per barrel of imported oil, with a most likely estimate of \$7.10 per barrel of imports (all figures are in 2007\$). According to these estimates, each gallon of fuel saved that results in a reduction in U.S. petroleum imports (either crude petroleum or refined fuel) will reduce the expected costs of oil supply disruptions to the U.S. economy by \$0.078 to \$0.269, with the actual value most likely to be \$0.169 per gallon (again in 2007\$). Unlike the reduction in monopsony payments that results from lower U.S. petroleum imports, however, the reduction in these expected disruption costs represents a real savings in resources, and thus contributes economic benefits in addition to the savings in resource costs for fuel production that would result from increasing fuel economy. NHTSA employs these values in its evaluation of the economic benefits from adopting higher CAFE standards for MY 2012-2016 cars and light trucks.

The third component of the external economic costs of importing oil into the U.S. includes government outlays for maintaining a military presence to secure the supply of oil imports from potentially unstable regions of the world and protect against their interruption. Some analysts also include outlays for maintaining the U.S. Strategic Petroleum Reserve (SPR) as an additional cost of U.S. dependence on oil imports, since the SPR is intended to cushion the U.S. economy against the consequences of disruption in the supply of imported oil.

NHTSA currently believes that while costs for U.S. military security may vary over time in response to long-term changes in the actual level of oil imports into the U.S., these costs are unlikely to decline in response to any reduction in U.S. oil imports resulting from raising future CAFE standards for light-duty vehicles. U.S. military activities in regions that represent vital sources of oil imports also serve a broader range of security and foreign policy objectives than simply protecting oil supplies, and as a consequence are unlikely to vary significantly in response to changes in the level of oil imports prompted by higher standards.

Neither the Congress nor the Executive Branch has ever attempted to calibrate U.S. military expenditures, force levels, or deployments to any oil market variable, or to some calculation of

the projected economic consequences of hostilities in the Persian Gulf. Instead, changes in U.S. force levels, deployments, and thus military spending in that region have been largely governed by political events, emerging threats, and other military and political considerations, rather than by shifts in U.S. oil consumption or imports. NHTSA thus concludes that the levels of U.S. military activity and expenditures are likely to remain unaffected by even relatively large changes in light duty vehicle fuel consumption. As a consequence, the agency's analysis of alternative CAFE standards for MY 2012-2016 does not include savings in budgetary outlays to support U.S. military activities among the benefits of higher fuel economy and the resulting fuel savings.

Nevertheless, the agency conducted a sensitivity analysis of the potential effect of assuming that some reduction in military spending would result from fuel savings and reduced petroleum imports in order to investigate its impacts on the standards and fuel savings. Assuming that the preceding estimate of total U.S. military costs for securing Persian Gulf oil supplies is correct, and that approximately half of these expenses could be reduced in proportion to a reduction in U.S. oil imports from the region, the estimated savings would range from \$0.02 to \$0.08 (in 2007 dollars) for each gallon of fuel savings that was reflected in lower U.S. imports of petroleum from the Persian Gulf. If the Persian Gulf region is assumed to be the marginal source of supply for U.S. imports of crude petroleum and refined products, then each gallon of fuel saved might reduce U.S. military outlays by \$0.05 per gallon, the midpoint of this range. NHTSA employs this estimate in its sensitivity analysis.

Similarly, while the optimal size of the SPR from the standpoint of its potential influence on domestic oil prices during a supply disruption may be related to the level of U.S. oil consumption and imports, its actual size has not appeared to vary in response to recent changes in oil imports. Thus while the budgetary costs for maintaining the Reserve are similar to other external costs in that they are not likely to be reflected in the market price for imported oil, these costs do not appear to have varied in response to changes in oil import levels. As a result, the agency's analysis of benefits from alternative CAFE standards for MY 2012-2016 does not include cost savings from maintaining a smaller SPR among the external benefits of reducing gasoline consumption and petroleum imports by means of tightening future CAFE standards. This view concurs with that of the recent ORNL study of economic costs from U.S. oil imports, which concludes that savings in government outlays for these purposes are unlikely to result from reductions in consumption of petroleum products and oil imports on the scale of those resulting from higher CAFE standards.

The Impact of Fuel Savings on U.S. Petroleum Imports

Based on a detailed analysis of differences in fuel consumption, petroleum imports, and imports of refined petroleum products among the Reference Case, High Economic Growth, and Low Economic Growth Scenarios presented in the Energy Information Administration's *Annual Energy Outlook 2009*, NHTSA estimates that approximately 50 percent of the reduction in fuel consumption resulting from adopting higher CAFE standards is likely to be reflected in reduced U.S. imports of refined fuel, while the remaining 50 percent would be expected to be reflected in

reduced domestic fuel refining.²³⁸ Of this latter figure, 90 percent is anticipated to reduce U.S. imports of crude petroleum for use as a refinery feedstock, while the remaining 10 percent is expected to reduce U.S. domestic production of crude petroleum.²³⁹ Thus on balance, each gallon of fuel saved as a consequence of higher CAFE standards is anticipated to reduce total U.S. imports of crude petroleum or refined fuel by 0.95 gallons.²⁴⁰

Benefits from Reducing Greenhouse Gas Emissions

Emissions of carbon dioxide and other greenhouse gases (GHGs) occur throughout the process of producing and distributing transportation fuels, as well as from fuel combustion itself. By reducing the volume of fuel consumed by passenger cars and light trucks, higher CAFE standards will thus reduce GHG emissions generated by fuel use, as well as throughout the fuel supply cycle. Lowering these emissions is likely to slow the projected pace and reduce the ultimate extent of future changes in the global climate, thus reducing future economic damages that changes in the global climate are otherwise expected to cause. Further, by reducing the probability that climate changes with potentially catastrophic economic or environmental impacts will occur, lowering GHG emissions may also result in economic benefits that exceed the resulting reduction in the expected future economic costs caused by gradual changes in the earth's climatic systems.

Quantifying and monetizing benefits from reducing GHG emissions is thus an important step in estimating the total economic benefits likely to result from establishing higher CAFE standards. The agency estimated emissions of carbon dioxide (CO₂) from passenger car and light truck use by multiplying the number of gallons of each type of fuel (gasoline and diesel) they are projected to consume with each alternative CAFE standard in effect by the quantity or mass of CO₂ emissions released per gallon of fuel consumed. This calculation assumes that the entire carbon content of each fuel is ultimately converted to CO₂ emissions during the combustion process. Carbon dioxide emissions account for nearly 95% of total GHG emissions that result from fuel combustion during vehicle use.

Since direct estimates of the economic benefits from reducing GHG emissions are generally not reported in published literature on the impacts of climate change, these benefits are typically assumed to be the “mirror image” of the estimated incremental costs resulting from an increase in those emissions. That is, the benefits from reducing emissions are usually measured by the savings in estimated economic damages that an equivalent increase in emissions would otherwise have caused.

The “social cost of carbon” (SCC) is intended to be a monetary measure of the incremental damage resulting from carbon dioxide (CO₂) emissions, including (but not limited to) net agricultural productivity loss, human health effects, property damages from sea level rise, and

²³⁸ Differences between forecast annual U.S. imports of crude petroleum and refined products among these three scenarios range from 24-89% of differences in projected annual gasoline and diesel fuel consumption in the U.S. These differences average 49% over the forecast period spanned by *AEO 2009*.

²³⁹ Differences between forecast annual U.S. imports of crude petroleum among these three scenarios range from 67-97% of differences in total U.S. refining of crude petroleum, and average 85% over the forecast period spanned by *AEO 2009*.

²⁴⁰ This figure is calculated as $0.50 + 0.50 \times 0.9 = 0.50 + 0.45 = 0.95$.

changes in ecosystem services. Any effort to quantify and to monetize the consequences associated with climate change will raise serious questions of science, economics, and ethics. But with full regard for the limits of both quantification and monetization, the SCC can be used to provide an estimate of the social benefits of reductions in GHG emissions.

For at least four reasons, any particular figure will be contestable. First, scientific and economic knowledge about the impacts of climate change continues to grow. With new and better information about relevant questions, including the cost, burdens, and possibility of adaptation, current estimates will inevitably change over time. Second, some of the likely and potential damages from climate change -- for example, the loss of endangered species—are generally not included in current SCC estimates. These omissions may turn out to be significant; in the sense that they may mean that the best current estimates are too low. As noted by the IPCC Fourth Assessment Report,” It is *very likely* that globally aggregated figures underestimate the damage costs because they cannot include many non-quantifiable impacts...” Third, it is unlikely that the damage estimates account for the directed technological change that will lead to innovations that reduce the costs of responding to climate change—for example, it is likely that scientists will develop crops that are better able to withstand high temperatures. In this respect, the current estimates may overstate the likely damages. Fourth, controversial ethical judgments, including those involving the treatment of future generations, play a role in judgments about the SCC (see in particular the discussion of the discount rate, below).

To date, SCC estimates presented in recent regulatory documents have varied within and among agencies, including DOT, DOE, and EPA. For example, a regulation proposed by DOT in 2008 assumed a value of \$7 per ton CO₂²⁴¹ (2006\$) for 2011 emission reductions (with a range of \$0-14 for sensitivity analysis). A regulation finalized by DOE used a range of \$0-\$20 (2007\$). Both of these ranges were designed to reflect the value of damages to the United States resulting from carbon emissions, or the “domestic” SCC. In the final MY2011 CAFE EIS, DOT used both a domestic SCC value of \$2/tCO₂ and a global SCC value of \$33/tCO₂ (with sensitivity analysis at \$80/tCO₂), increasing at 2.4% per year thereafter. The final MY2011 CAFE rule also presented a range from \$2 to \$80/tCO₂. EPA’s Advance Notice of Proposed Rulemaking for Greenhouse Gases discussed the benefits of reducing GHG emissions and identified what it described as “very preliminary” SCC estimates “subject to revision” that spanned three orders of magnitude. EPA’s global mean values were \$68 and \$40/tCO₂ for discount rates of 2% and 3% respectively (in 2006 real dollars for 2007 emissions).²⁴²

The current Administration has worked to develop a transparent methodology for selecting a set of interim SCC estimates to use in regulatory analyses until a more comprehensive characterization of the distribution of SCC is developed. This discussion proposes a set of values for the interim social cost of carbon. It should be emphasized that the analysis here is preliminary. Today’s proposed joint rulemaking presents SCC estimates that reflect the

²⁴¹ For the purposes of this discussion, we present all values of the SCC as the cost per ton of CO₂ emissions. Some discussions of the SCC in the literature use an alternative presentation of a dollar per ton of Carbon. The standard adjustment factor is 3.67, which means, for example, that a SCC of \$10 per ton of CO₂ would be equivalent to a cost of \$36.70 for a ton of carbon emitted.

²⁴² 73 FR 44416 (July 30, 2008). EPA, “Advance Notice of Proposed Rulemaking for Greenhouse Gases Under the Clean Air Act, Technical Support Document on Benefits of Reducing GHG Emissions,” June 2008. www.regulations.gov. Search for ID “EPA-HQ-OAR-2008-0318-0078.”

Administration's current understanding of the relevant literature. These interim estimates are being used for the short-term while an interagency group develops a more comprehensive characterization of the distribution of SCC values for future economic and regulatory analyses. The interim values should not be viewed as a statement about the results of the longer-term process. The Administration will be evaluating and seeking comment in the preamble to today's proposed rule on all of the scientific, economic, and ethical issues before establishing final estimates for use in future rulemakings.

The outcomes of the Administration's process to develop interim values are judgments in favor of a) global rather than domestic values, b) an annual growth rate of 3%, and c) interim global SCC estimates for 2007 (in 2006 dollars) of \$55, \$33, \$19, \$10, and \$5 per ton of CO₂. Notably, we have centered our current attention on a SCC of \$19. The proposed figures are based on the following judgments.

1. *Global and domestic measures.* Because of the distinctive nature of the climate change problem, we present both a global SCC and a fraction of that value that represents impacts that may occur within the borders of the U.S. alone, or a "domestic" SCC, but center our current attention on the global measure. This approach represents a departure from past practices, which relied, for the most part, on domestic measures. As a matter of law, both global and domestic values are permissible; the relevant statutory provisions are ambiguous and allow selection of either measure.²⁴³

It is true that under OMB guidance, analysis from the domestic perspective is required, while analysis from the international perspective is optional. The domestic decisions of one nation are not typically based on a judgment about the effects of those decisions on other nations. But the climate change problem is highly unusual in the sense that it involves (a) a global public good in which (b) the emissions of one nation may inflict significant damages on other nations and (c) the United States is actively engaged in promoting an international agreement to reduce worldwide emissions.

In these circumstances, we believe the global measure is preferred. Use of a global measure reflects the reality of the problem and is expected to contribute to the continuing efforts of the United States to ensure that emissions reductions occur in many nations.

Domestic SCC values are also presented. The development of a domestic SCC is greatly complicated by the relatively few region- or country-specific estimates of the SCC in the literature. One potential domestic estimate comes from the DICE models. In an unpublished paper, Nordhaus (2007) produced disaggregated SCC estimates using a regional version of the DICE model. He reported a U.S. estimate of \$1/tCO₂ (2007 value, 2007\$), which is roughly 11% of the global value.²⁴⁴

²⁴³ It is true that federal statutes are presumed not to have extraterritorial effect, in part to ensure that the laws of the United States respect the interests of foreign sovereigns. But use of a global measure for the SCC does not give extraterritorial effect to federal law and hence does not intrude on such interests.

²⁴⁴ Personal communication (add cite to unpublished 2007 Nordhaus paper)

An alternative source of estimates comes from a recent unpublished EPA modeling effort using the FUND model. The resulting estimates suggest that the ratio of domestic to global benefits varies with key parameter assumptions. With a 3% discount rate, for example, the US benefit is about 6% of the global benefit for the “central” (mean) FUND results, while, for the corresponding “high” estimates associated with a higher climate sensitivity and lower global economic growth, the U.S. benefit is less than 4% of the global benefit. With a 2% discount rate, the U.S. share is about 2-5% of the global estimate.

Based on this available evidence, an interim domestic SCC value equal to 6% of the global damages is proposed. This figure is in the middle of the range of available estimates from the literature. It is recognized that the 6% figure is approximate and highly speculative and alternative approaches will be explored before establishing final values for future rulemakings.

2. *Filtering existing analyses.* There are numerous SCC estimates in the existing literature, and it is reasonable to make use of those estimates in order to produce a figure for current use. A starting point is provided by the meta-analysis in Richard Tol, 2008.²⁴⁵ With that starting point, the Administration proposes to “filter” existing SCC estimates by using those that (1) are derived from peer-reviewed studies; (2) do not weight the monetized damages to one country more than those in other countries; (3) use a “business as usual” climate scenario; and (4) are based on the most recent published version of each of the three major integrated assessment models (IAMs): FUND, PAGE, and DICE.

Proposal (1) is based on the view that those studies that have been subject to peer review are more likely to be reliable than those that have not been. Proposal (2) is based on a principle of neutrality and simplicity; it does not treat the citizens of one nation (or different citizens within the US) differently on the basis of speculative or controversial considerations. Further it is consistent with the potential compensation tests of Kaldor (1939) and Hicks (1940), which use unweighted sums of willingness to pay.²⁴⁶ Finally, this is the approach used in rulemakings across a variety of settings and consequently keeps USG policy consistent across contexts.

Proposal (3) stems from the judgment that as a general rule, the proper way to assess a policy decision is by comparing the implementation of the policy against a counterfactual state where the policy is not implemented. In addition, our expectation is that most policies to be evaluated using these interim SCC estimates will constitute small enough changes to the larger economy to safely assume that the marginal benefits of emissions reductions will not change between the baseline and policy scenarios. A departure from this approach would be to consider a more dynamic setting in which other countries might implement policies to reduce GHG emissions at an unknown future date and the US could choose to implement such a policy now or at a future date.

²⁴⁵ Richard Tol, *The Social Cost of Carbon: Trends, Outliers, and Catastrophes*, *Economics: The Open-Access, Open-Assessment E-Journal*, Vol. 2, 2008-25. <http://www.economics-ejournal.org/economics/journalarticles/2008-25> (2008).

Proposal (4) is based on four complementary judgments. First, the FUND, PAGE, and DICE models now stand as the most comprehensive and reliable efforts to measure the economic damages from climate change. Second, the latest versions of the three IAMs are likely to reflect the most recent evidence and learning, and hence they are presumed to be superior to those that preceded them. Third, any effort to choose among them, or to reject one in favor of the others, would be difficult to defend at the present time. In the absence of a clear reason to choose among them, it is reasonable to base the SCC on all of them. Fourth, in light of the uncertainties associated with the SCC, the additional information offered by different models is important.

3. *Use a model-weighted average of the estimates at each discount rate.* At this time, a scientifically valid reason to prefer any of the three major IAMs (FUND, PAGE, and DICE) has not been identified. Accordingly, to address the concern that certain models not be given unequal weight relative to the other models, the estimates are based on an equal weighting of the means of the estimates from each of the models. Among estimates that remain after applying the filter, we begin by taking the average of all estimates within a model. The estimated SCC is then calculated as the average of the three model-specific averages. This approach is used to ensure that models with a greater number of published results do not exert unequal weight on the interim SCC estimates.

4. *Apply a 3% annual growth rate to the chosen SCC values.* SCC is assumed to increase over time, because future emissions are expected to produce larger incremental damages as physical and economic systems become more stressed as the magnitude of climate change increases. Indeed, an implied growth rate in the SCC can be produced by most of the models that estimate economic damages caused by increased GHG emissions in future years. But neither the rate itself nor the information necessary to derive its implied value is commonly reported. In light of the limited amount of debate thus far about the appropriate growth rate of the SCC, applying a rate of 3% per year seems appropriate at this stage. This value is consistent with the range recommended by IPCC (2007) and close to the latest published estimate (Hope 2008).

Discount Rates

For estimation of the benefits associated with the mitigation of climate change, one of the most complex issues involves the appropriate discount rate. OMB's current guidance offers a detailed discussion of the relevant issues and calls for discount rates of 3% and 7%. It also permits a sensitivity analysis with low rates (1 – 3%) for intergenerational problems: "If your rule will have important intergenerational benefits or costs you might consider a further sensitivity analysis using a lower but positive discount rate in addition to calculating net benefits using discount rates of 3 and 7 percent."²⁴⁷

²⁴⁷ See OMB Circular A-4, pp. 35-36, citing Portney and Weyant, eds. (1999), *Discounting and Intergenerational Equity, Resources for the Future*, Washington, DC.

The choice of a discount rate, especially over long periods of time, raises highly contested and exceedingly difficult questions of science, economics, philosophy, and law. See, e.g., William Nordhaus, *The Challenge of Global Warming* (2008); Nicholas Stern, *The Economics of Climate Change* (2007); *Discounting and Intergenerational Equity* (Paul Portney and John Weyant eds. 1999). It is not clear that future generations would be willing to trade environmental quality for consumption at the same rate as the current generations. Under imaginable assumptions, decisions based on cost-benefit analysis with high discount rates might harm future generations – at least if investments are not made for the benefit of those generations. See Robert Lind, *Analysis for Intergenerational Discounting*, id. at 173, 176-177. It is also possible that the use of low discount rates for particular projects might itself harm future generations, by ensuring that resources are not used in a way that would greatly benefit them. In the context of climate change, questions of intergenerational equity are especially important.

Reasonable arguments support the use of a 3% discount rate. First, that rate is among the two figures suggested by OMB guidance, and hence it fits with existing national policy. Second, it is standard to base the discount rate on the compensation that people receive for delaying consumption, and the 3% is close to the risk-free rate of return, proxied by the return on long term inflation-adjusted US Treasury Bonds, as of this writing. Although these rates are currently closer to 2.5%, the use of 3% provides an adjustment for the liquidity premium that is reflected in these bonds' returns.

At the same time, others would argue that a 5% discount rate can be supported. The argument relies on several assumptions. First, that rate can also be justified by reference to the level of compensation for delaying consumption, because it fits with market behavior with respect to *individuals'* willingness to trade-off consumption across periods as measured by the estimated post-tax average real returns to risky private investments (e.g., the S&P 500). In the climate setting, the 5% discount rate may be preferable to the riskless rate because it is based on risky investments and the return to projects to mitigate climate change is also risky. In contrast, the 3% riskless rate may be a more appropriate discount rate for projects where the return is known with a high degree of confidence (e.g., highway guardrails). In principal, the correct discount rate would reflect the variance in payoff from climate mitigation policy and the correlation between the payoffs of the policy and the broader economy.²⁴⁸

Second, 5%, and not 3%, is roughly consistent with estimates implied by reasonable inputs to the theoretically derived Ramsey equation, which specifies the optimal time path for consumption. That equation specifies the optimal discount rate as the sum of two components. The first term (the product of the elasticity of the marginal utility of consumption and the growth rate of consumption) reflects the fact that consumption in the future is likely to be higher than consumption today, so diminishing marginal utility implies that the same monetary damage will cause a smaller reduction of utility in the future. Standard estimates of this term from the economics literature are in the range of 3%-5% [cite sources here]. The second component reflects the possibility that a lower weight should be placed on utility in the future, to account for

²⁴⁸ Specifically, if the benefits of the policy are highly correlated with the returns from broader economy, then the market rate should be used to discount the benefits. If the benefits are uncorrelated with the broader economy the long term government bond rate should be applied. Furthermore, if the benefits are negatively correlated with the broader economy a rate less than that on long term government bonds should be used (Lind, 1982 pp. 89-90).

social impatience or extinction risk, which is specified by a pure rate of time preference (PRTP). A common estimate of the PRTP is 2%, though some observers believe that a principle of intergenerational equity suggests that the PRTP should be close to zero. It follows that discount rate of 5% is near the middle of the range of values that are able to be derived from the Ramsey equation.

It is recognized that the arguments above – for use of market behavior and the Ramsey equation – face objections in the context of climate change, and of course there are alternative approaches. In light of climate change, it is possible that consumption in the future will not be higher than consumption today, and if so, the Ramsey equation will suggest a lower figure. However, the historical evidence is consistent with rising consumption over time.

Some critics note that using observed interest rates for inter-generational decisions imposes current preferences on future generations, which some economists say may not be appropriate. For generational equity, they argue that the discount rate should be below market rates to correct for market distortions and inefficiencies in intergenerational transfers of wealth (which are presumed to compensate future generations for damage), and to treat generations equitably based on ethical principles (see Broome 2008).²⁴⁹

Additionally, some analyses attempt to deal with uncertainty with respect to interest rates over time. We explore below how this might be done.²⁵⁰

Proposed Interim Estimates

The application of the methodology outlined above yields interim estimates of the SCC that are reported in Table 1. These estimates are reported separately using 3% and 5% discount rates. The cells are empty in rows 10 and 11, because these studies did not report estimates of the SCC at a 3% discount rate. The model-weighted means are reported in the final or summary row; they are \$33 per tCO₂ at a 3% discount rate and \$5 per tCO₂ with a 5% discount rate.

Table VIII-7
Global Social Cost of Carbon (SCC) Estimates (\$/tCO₂ in 2007 (2006\$))
Based on 3% and 5% Discount Rates *

	Model	Study	Climate Scenario	3%	5%
1	FUND	Anthoff et al. 2009	FUND default	6	-1
2	FUND	Anthoff et al. 2009	SRES A1b	1	-1
3	FUND	Anthoff et al. 2009	SRES A2	9	-1
4	FUND	Link and Tol 2004	No THC	12	3
5	FUND	Link and Tol 2004	THC continues	12	2

²⁴⁹ See Arrow, K.J., W.R. Cline, K-G Maler, M. Munasinghe, R. Squiteri, J.E. Stiglitz, 1996. "Intertemporal equity, discounting and economic efficiency," in *Climate Change 1995: Economic and Social Dimensions of Climate Change*, Contribution of Working Group III to the Second Assessment Report of the Intergovernmental Panel on Climate Change. See also Weitzman, M.L., 1999. In Portney P.R. and Weyant J.P. (eds.), *Discounting and Intergenerational Equity, resources for the Future*, Washington, D.C.

²⁵⁰ Richard Newell and William Pizer, Discounting the distant future: how much do uncertain rates increase valuations? *J. Environ. Econ. Manage.* 46 (2003) 52-71.

6	FUND	Guo et al. 2006	Constant PRTP	5	-1
7	FUND	Guo et al. 2006	Gollier discount 1	14	0
8	FUND	Guo et al. 2006	Gollier discount 2	7	-1
			FUND Mean	8.25	0
9	PAGE	Wahba & Hope 2006	A2-scen	57	7
10	PAGE	Hope 2006			7
11	DICE	Nordhaus 2008			8
Summary			Model-weighted Mean	33	5

*The sample includes all peer reviewed, non-equity-weighted estimates included in Tol (2008), Nordhaus (2008), Hope (2008), and Anthoff et al. (2009), that are based on the most recent published version of FUND, PAGE, or DICE and use business-as-usual climate scenarios.^{251,252} All values are based on the best available information from the underlying studies about the base year and year dollars, rather than the Tol (2008) assumption that all estimates included in his review are 1995 values in 1995\$. All values were updated to 2007 using a 3% annual growth rate in the SCC, and adjusted for inflation using GDP deflator.

Analyses have been conducted at \$33 and \$5 as these represent the estimates associated with the 3% and 5% discount rates, respectively.²⁵³ The 3% and 5% estimates have independent appeal and at this time a clear preference for one over the other is not warranted. Thus, we have also included – and centered our current attention on – the average of the estimates associated with these discount rates, which is \$19. (Based on the \$19 global value, the approximate domestic fraction of these benefits would be \$1.14 per ton of CO₂ assuming that domestic benefits are 6% of the global benefits.

It is true that there is uncertainty about interest rates over long time horizons. Recognizing that point, Newell and Pizer (2003) have made a careful effort to adjust for that uncertainty. The Newell-Pizer approach models discount rate uncertainty as something that evolves over time.²⁵⁴

²⁵¹ Most of the estimates in Table 1 rely on climate scenarios developed by the Intergovernmental Panel on Climate Change (IPCC). The IPCC published a new set of scenarios in 2000 for use in the Third Assessment Report (Special Report on Emissions Scenarios - SRES). The SRES scenarios define four narrative storylines: A1, A2, B1 and B2, describing the relationships between the forces driving greenhouse gas and aerosol emissions and their evolution during the 21st century for large world regions and globally. Each storyline represents different demographic, social, economic, technological, and environmental developments that diverge in increasingly irreversible ways. The storylines are summarized in Nakicenovic et al., 2000 (see also <http://sedac.ciesin.columbia.edu/ddc/sres/>). Because the B1 and B2 storylines represent policy cases rather than business-as-usual projections, estimates derived from these scenarios to be less appropriate for use in benefit-cost analysis. They are therefore excluded.

²⁵² Guo et al. (2006) report estimates based on two Gollier discounting schemes. The Gollier discounting assumes complex specifications about individual utility functions and risk preferences. After various conditions are satisfied, declining social discount rates emerge. Gollier Discounting Scheme 1 employs a certainty-equivalent social rate of time preference (SRTP) derived by assuming the regional growth rate is equally likely to be 1% above or below the original forecast growth rate. Gollier Discounting Scheme 2 calculates a certainty-equivalent social rate of time preference (SRTP) using five possible growth rates, and applies the new SRTP instead of the original. Hope (2008) conducts Monte Carlo analysis on the PRTP component of the discount rate. The PRTP is modeled as a triangular distribution with a min value of 1%/yr, a most likely value of 2 %/yr, and a max value of 3 %/yr.

²⁵³ It should be noted that reported discount rates may not be consistently derived across models or specific applications of models: while the discount rate may be identical, it may reflect different assumptions about the individual components of the Ramsey equation identified earlier.

²⁵⁴ In contrast, an alternative approach based on Weitzman (2001) would assume that there is a constant discount

This is a relatively recent contribution to the literature and estimates based on this method are included with the aim of soliciting comment.

There are several concerns with using this approach in this context. First, it would be a departure from current OMB guidance. Second, an approach that would average what emerges from discount rates of 3% and 5% reflects uncertainty about the discount rate, but based on a different model of uncertainty. The Newell-Pizer approach models discount rate uncertainty as something that evolves over time; in contrast, the preferred approach (outlined above) assumes that there is a single discount rate with equal probability of 3% and 5%.

Table 2 reports on the application of the Newell-Pizer adjustments. The precise numbers depend on the assumptions about the data generating process that governs interest rates. Columns (1a) and (1b) assume that “random walk” model best describes the data and uses 3% and 5% discount rates, respectively. Columns (2a) and (2b) repeat this, except that it assumes a “mean-reverting” process. While the empirical evidence does not rule out a mean-reverting model, Newell and Pizer find stronger empirical support for the random walk model.

Table 2: Global Social Cost of Carbon (SCC) Estimates (\$/tCO₂ in 2007 (2006\$))*,
Using Newell & Pizer (2003) Adjustment for Future Discount Rate Uncertainty**

Mode I	Study	Climate Scenario	Random- walk model		Mean- reverting model		
			3% (1a)	5% (1b)	3% (2a)	5% (2b)	
1	FUND	Anthoff et al. 2009	FUND default	10	0	7	-1
2	FUND	Anthoff et al. 2009	SRES A1b	2	0	1	-1
3	FUND	Anthoff et al. 2009	SRES A2	15	0	10	-1
4	FUND	Link and Tol 2004	No THC	20	6	13	4
5	FUND	Link and Tol 2004	THC continues	20	4	13	2
6	FUND	Guo et al. 2006	Constant PRTP	9	0	6	-1
7	FUND	Guo et al. 2006	Gollier discount 1	14	0	14	0
8	FUND	Guo et al. 2006	Gollier discount 2	7	-1	7	-1
			FUND Mean	12	1	9	0
9	PAGE	Wahba & Hope 2006	A2-scen	97	13	63	8
10	PAGE	Hope 2006			13		8
11	DICE	Nordhaus 2008			15		9
			Model-weighted Mean	55	10	36	6

rate that is uncertain and represented by a probability distribution. The Newell and Pizer, and Weitzman approaches are relatively recent contributions and we invite comment on the advantages and disadvantages of each.

*The sample includes all peer reviewed, non-equity-weighted estimates included in Tol (2008), Nordhaus (2008), Hope (2008), and Anthoff et al. (2009), that are based on the most recent published version of FUND, PAGE, or DICE and use business-as-usual climate scenarios. All values are based on the best available information from the underlying studies about the base year and year dollars, rather than the Tol (2008) assumption that all estimates included in his review are 1995 values in 1995\$. All values were updated to 2007 using a 3% annual growth rate in the SCC, and adjusted for inflation using GDP deflator. See the Notes to Table 1 for further details.

**Assumes a starting discount rate of 3% or 5%. Newell and Pizer (2003) based adjustment factors are not applied to estimates from Guo et al. (2006) that use a different approach to account for discount rate uncertainty (rows 7-8). Note that the correction factor from Newell and Pizer is based on the DICE model. The proper adjustment may differ for other integrated assessment models that produce different time schedules of marginal damages. We would expect this difference to be minor.

The resulting estimates of the social cost of carbon are necessarily greater. When the adjustments from the random walk model are applied, the estimates of the social cost of carbon are \$10 and \$55 per ton of CO₂, with the 5% and 3% discount rates, respectively. The application of the mean-reverting adjustment yields estimates of \$6 and \$36. Relying on the random walk model, analyses are also conducted with the value of the SCC set at \$10 and \$55.

All of the values derived from this process are expressed in 2006 dollars. NHTSA has adjusted them to their equivalent values in 2007 dollars for consistency with other values used in its analysis of benefits from adopting higher CAFE standards for MY 2012-2016 passenger cars and light trucks. The resulting primary value is equivalent to \$20 per metric ton of CO₂ emissions avoided when expressed in 2007\$, and the agency has relied on this value in its analysis. NHTSA has also analyzed the sensitivity of its benefit estimates to alternative values of \$5, \$10, \$34, and \$56 per metric ton of CO₂ emissions avoided, with all figures again in 2007\$. Each of these values applies to emissions during 2007, and is assumed to grow in real terms by 3% annually beginning in 2007.

Caveats:

There are at least four caveats to the approach outlined above.

First, the impacts of climate change are expected to be widespread, diverse, and heterogeneous. In addition, the exact magnitude of these impacts is uncertain, because of the inherent randomness in the Earth's atmospheric processes, the U.S. and global economies, and the behaviors of current and future populations. Current IAM do not currently individually account for and assign value to all of the important physical and other impacts of climate change that are recognized in the climate change literature. Although it is likely that our capability to quantify and monetize impacts will improve with time, it is also likely that even in future applications, there are a number of potentially significant benefits categories that will remain unmonetized.

Second, in the opposite direction, it is unlikely that the damage estimates adequately account for the directed technological change that climate change will cause. In particular, climate change will increase the return on investment to develop technologies that allow individuals to better cope with climate change. For example, it is likely that scientists will develop crops that are better able to withstand high temperatures. In this respect, the current estimates may overstate the likely damages

Third, there has been considerable recent discussion of the risk of catastrophic impacts and of how best to account for worst-case scenarios. Recent research by Weitzman (2009) specifies some conditions under which the possibility of catastrophe would undermine the use of IAMs and conventional cost-benefit analysis. This research requires further exploration before its generality is known and the optimal way to incorporate it into regulatory reviews is understood.

Fourth, it is also worth noting that the SCC estimates are only relevant for incremental policies relative to the projected baselines, which capture business-as-usual scenarios. To evaluate non-marginal changes, such as might occur if the U.S. acts in tandem with other nations, then it might be necessary to go beyond the simple expedient of using the SCC along the BAU path. In particular, it would be correct to calculate the aggregate WTP to move from the BAU scenario to the policy scenario, without imposing the restriction that the marginal benefit remains constant over this range.

Benefits from Reducing Emissions of Criteria Air Pollutants

Car and light truck use, fuel refining, and fuel distribution and retailing also generate emissions of certain criteria air pollutants, including carbon monoxide (CO), hydrocarbon compounds (usually referred to as “volatile organic compounds,” or VOC), nitrogen oxides (NO_x), fine particulate matter (PM_{2.5}), and sulfur dioxide (SO₂). While reductions in fuel refining and distribution that result from lower fuel consumption will reduce emissions of criteria pollutants, additional vehicle use associated with the rebound effect from higher fuel economy will increase emissions of these pollutants. Thus the net effect of stricter CAFE standards on total emissions of each criteria pollutant depends on the relative magnitudes of reduced emissions in fuel refining and distribution, and increases in emissions from vehicle use. Because the relationship between emission rates (emissions per gallon refined of fuel or mile driven) in fuel refining and vehicle use is different for each criteria pollutant, the net effect of fuel savings from increased CAFE standards on total emissions of each pollutant is likely to differ.

NHTSA estimates the increase in emissions of each criteria air pollutant from additional vehicle use by multiplying the increase in total miles driven by cars and light trucks of each model year and age by their estimated emission rates per vehicle-mile of each pollutant. These emission rates differ between cars and light trucks as well as between gasoline and diesel vehicles, and both their values for new vehicles and the rates at which they increase with age and accumulated mileage can vary among model years. With the exception of SO₂, NHTSA calculated the increase in emissions of these criteria pollutants from added car and light truck use by multiplying the estimated increases in their vehicles’ use during each year over their expected lifetimes by per-mile emission rates appropriate to each vehicle type, fuel used, model year, and age as of that future year.

These emission rates were developed by U.S. EPA using its recently-developed Motor Vehicle Emission Simulator (Draft MOVES 2009). The MOVES model assumes that the per-mile rates at which these pollutants are emitted are determined by EPA regulations and the effectiveness of catalytic after-treatment of engine exhaust emissions, and are thus unaffected by changes in car and light truck fuel economy. As a consequence, the effects of required increases in fuel economy emissions of these pollutants from car and

light truck use are determined entirely by the increases in driving that result from the fuel economy rebound effect.

Emission factors in the MOVES database are expressed in the form of grams per vehicle-hour of operation. To convert these emission factors to grams per mile for use in NHTSA's calculations, MOVES was run for the year 2050, and was programmed to report aggregate emissions from vehicle starting, operation, storage, and refueling. EPA analysts selected the year 2050 in order to generate emission factors that were representative of lifetime average emission rates for vehicles meeting the agency's Tier 2 emission standard.²⁵⁵ Separate estimates were developed for each vehicle type and model year, as well as for each state and month, in order to reflect the effects of regional and temporal variation in temperature and other relevant variables on emissions.

The MOVES emissions estimates were then summed to the model year level and divided by average distance traveled in order to produce per-mile emission factors for each pollutant. The resulting emission rates represent average values across the nation, and incorporate typical temperature variations over an entire calendar year. These national average rates also reflect county-specific differences in fuel composition, as well as in the presence and type of vehicle inspection and maintenance programs.²⁵⁶

Emission rates for the criteria pollutant SO₂ were calculated by NHTSA using average fuel sulfur content estimates supplied by EPA, together with the assumption that the entire sulfur content of fuel is emitted in the form of SO₂. These calculations assumed that national average gasoline and diesel sulfur levels would remain at current levels.²⁵⁷ Total SO₂ emissions under each alternative CAFE standard were calculated by applying the resulting emission rates directly to annual gasoline and diesel fuel use by cars and light trucks that is projected to occur under that alternative. As with other impacts, the *changes* in emissions of criteria air pollutants resulting from alternative increases in CAFE standards for MY 2012-2016 cars and light trucks were calculated as the difference between emissions under each alternative that would increase CAFE standards and emissions under the baseline alternative, which would extend the MY 2011 standards to apply to future model years.

Emissions of criteria air pollutants also occur during each phase of fuel production and distribution, including crude oil extraction and transportation, fuel refining, and fuel storage and transportation. The reduction in emissions during each of these phases depends on the extent to

²⁵⁵ Because all light-duty emission rates in Draft MOVES 2009 are assumed to be invariant after MY 2010, a calendar-year 2050 run produced a full set of emission rates that reflect anticipated deterioration in the effectiveness of vehicles' emission control systems with increasing age and accumulated mileage for post-MY 2010 vehicles.

²⁵⁶ The national mix of fuel types includes county-level market shares of conventional and reformulated gasoline, as well as county-level variation in sulfur content, ethanol fractions, and other fuel properties. Inspection/maintenance programs at the county level account for detailed program design elements such as test type, inspection frequency, and program coverage by vehicle type and age.

²⁵⁷ These are 30 and 15 parts per million (ppm, measured on a mass basis) for gasoline and diesel respectively, which produces emission rates of 0.17 grams of SO₂ per gallon of gasoline and 0.10 grams per gallon of diesel.

which fuel savings result in lower imports of refined fuel, or in reduced domestic fuel refining. To a lesser extent, they also depend on whether reductions in domestic gasoline refining are reflected in reduced imports of crude oil or in reduced domestic extraction of petroleum. NHTSA's analysis assumes that reductions in imports of refined fuel would reduce criteria pollutant emissions during fuel storage and distribution only. Reductions in domestic fuel refining using imported crude oil as a feedstock are assumed to reduce emissions during fuel refining, storage, and distribution, because each of these activities would be reduced. Finally, reduced domestic fuel refining using domestically-produced crude oil is assumed to reduce emissions during all four phases of fuel production and distribution.²⁵⁸

NHTSA estimated the reductions in criteria pollutant emissions from producing and distributing fuel that would occur with alternative CAFE standards using emission rates obtained by EPA from Argonne National Laboratories' Greenhouse Gases and Regulated Emissions in Transportation (GREET) model.²⁵⁹ The GREET model provides separate estimates of air pollutant emissions that occur in four phases of fuel production and distribution: crude oil extraction, crude oil transportation and storage, fuel refining, and fuel distribution and storage.²⁶⁰ EPA modified the GREET model to change certain assumptions about emissions during crude petroleum extraction and transportation, as well as to update its emission rates to reflect adopted and pending EPA emission standards. The agency converted these emission rates from the mass per fuel energy content basis on which GREET reports them to mass per gallon of fuel supplied using the estimates of fuel energy content reported by GREET. The resulting emission rates were applied to the agency's estimates of fuel consumption under each alternative CAFE standard to develop estimates of total emissions of each criteria pollutant during fuel production and distribution. The assumptions about the effects of *changes* in fuel consumption on domestic and imported sources of fuel supply discussed above were then employed to calculate the effects of reductions in fuel use from alternative CAFE standards on changes in domestic emissions of each criteria pollutant.

Finally, NHTSA calculated the *net* changes in domestic emissions of each criteria pollutant by summing the increases in its emissions projected to result from increased vehicle use, and the reductions in emissions anticipated to result from lower domestic fuel refining and distribution.²⁶¹ As indicated previously, the effect of adopting higher CAFE standards on total emissions of each criteria pollutant depends on the relative magnitudes of the resulting reduction in emissions from fuel refining and distribution, and the increase in emissions from additional vehicle use. Although these net changes vary significantly among individual criteria pollutants,

²⁵⁸ In effect, this assumes that the distances crude oil travels to U.S. refineries are approximately the same regardless of whether it travels from domestic oilfields or import terminals, and that the distances that gasoline travels from refineries to retail stations are approximately the same as those from import terminals to gasoline stations.

²⁵⁹ Argonne National Laboratories, *The Greenhouse Gas and Regulated Emissions from Transportation (GREET) Model*, Version 1.8, June 2007, available at <http://www.transportation.anl.gov/software/GREET/index.html> (last accessed April 20, 2008).

²⁶⁰ Emissions that occur during vehicle refueling at retail gasoline stations (primarily evaporative emissions of volatile organic compounds, or VOCs) are already accounted for in the "tailpipe" emission factors used to estimate the emissions generated by increased light truck use. GREET estimates emissions in each phase of gasoline production and distribution in mass per unit of gasoline energy content; these factors are then converted to mass per gallon of gasoline using the average energy content of gasoline.

²⁶¹ All emissions from increased vehicle use are assumed to occur within the U.S., since CAFE standards would apply only to vehicles produced for sale in the U.S.

the agency projects that on balance, adopting higher CAFE standards would reduce emissions of all criteria air pollutants except carbon monoxide (CO).

The net changes in domestic emissions of fine particulates (PM_{2.5}) and its chemical precursors (such as NO_x, SO_x, and VOCs) are converted to economic values using estimates of the reductions in health damage costs per ton of emissions of each pollutant that is avoided, which were developed and recently revised by EPA. These savings represent the estimated reductions in the value of damages to human health resulting from lower atmospheric concentrations and population exposure to air pollution that occur when emissions of each pollutant that contributes to atmospheric PM_{2.5} concentrations are reduced. The value of reductions in the risk of premature death due to exposure to fine particulate pollution (PM_{2.5}) account for a majority of EPA's estimated values of reducing criteria pollutant emissions, although the value of avoiding other health impacts is also included in these estimates. These values do not include a number of unquantified benefits, such as reduction in the welfare and environmental impacts of PM_{2.5} pollution, or reductions in health and welfare impacts related to other criteria pollutants (ozone, NO₂, and SO₂) and air toxics. EPA estimates different PM-related per-ton values for reducing emissions from vehicle use than for reductions in emissions of that occur during fuel production and distribution. NHTSA applies these separate values to its estimates of changes in emissions from vehicle use and fuel production and distribution to determine the net change in total economic damages from emissions of these pollutants.

EPA projects that the per-ton values for reducing emissions of criteria pollutants from both mobile sources (including motor vehicles) and stationary sources such as fuel refineries and storage facilities will increase over time. These projected increases reflect rising income levels, which are assumed to increase affected individuals' willingness to pay for reduced exposure to health threats from air pollution, as well as future population growth, which increases population exposure to future levels of air pollution.

D Added Costs from Congestion, Crashes, and Noise

While it provides some benefits to drivers, increased vehicle use associated with the fuel economy rebound effect can also contribute to increased traffic congestion, motor vehicle crashes, and highway noise. Additional vehicle use can contribute to traffic congestion and delays by increasing recurring congestion on heavily-traveled roadways during peak travel periods, depending on how the additional travel is distributed over the day and on where it occurs. By increasing the number of crashes and disabled vehicles, added driving can also increase the delays that often result from these incidents, although the extent to which it actually does so again depends on when and where the added travel occurs.

In either case, added delays impose higher costs on drivers and other vehicle occupants in the form of increased travel time and operating expenses, and these should be considered as an additional economic cost associated with the rebound effect. Because drivers do not take these added costs into account in deciding when to make trips or where they travel, they must be accounted for separately as a cost of the added driving associated with the rebound effect.

Increased passenger car and light truck use due to the rebound effect may also increase the costs associated with traffic crashes. Drivers presumably take account of the potential costs they (and the other occupants of their vehicles) face from the possibility of being involved in a crash when they decide to make additional trips. However, they probably do not consider all of the potential costs they impose on occupants of other vehicles and on pedestrians when crashes occur, so any increase in these “external” crash costs must be considered as another cost of additional rebound-effect driving.

Like increased delay costs, any increase in these external crash costs caused by added driving is likely to depend on the traffic conditions under which it takes place, since crashes are more frequent in heavier traffic, but their severity may be reduced by the slower speeds at which heavier traffic typically moves. Thus estimates of the increase in external crash costs from the rebound effect also need to account for when and where the added driving occurs.

Finally, added vehicle use from the rebound effect may also increase traffic noise. Noise generated by vehicles causes inconvenience, irritation, and potentially even discomfort to occupants of other vehicles, to pedestrians and other bystanders, and to residents or occupants of surrounding property. Because none of these effects are likely to be taken into account by the drivers whose vehicles contribute to traffic noise, they represent additional externalities associated with motor vehicle use.

Although there is considerable uncertainty in estimating its value, the added inconvenience and irritation caused by increased traffic noise imposes some economic costs on those it affects, and these added costs are unlikely to be taken into account by drivers of the vehicles that cause it. Thus any increase in noise costs resulting from added vehicle use must be included together with other increases in external costs of additional rebound-effect driving.

NHTSA’s analysis uses estimates of the congestion, crash, and noise costs caused by increased travel in automobiles, pickup trucks, and vans developed by the Federal Highway Administration.²⁶² These estimates are intended to measure the *increases* in external costs – that is, the “marginal” external costs – from added congestion, property damages and injuries in traffic crashes, and noise levels caused by additional usage of cars and light trucks that are borne by persons other than their drivers. FHWA’s “Middle” estimates for congestion, crash, and noise costs imposed by passenger cars are 5.4 cents, 2.3 cents and 0.1 cents per additional vehicle mile when expressed in 2007 dollars.²⁶³ For pickup trucks and vans, FHWA’s estimates correspond to 4.8 cents, 2.6 cents, and 0.1 cents per additional vehicle-mile.

The Federal Highway Administration’s estimates of these costs agree closely with some other recent estimates. For example, recent published research conducted by Resources for the Future (RFF) estimates marginal congestion and external crash costs for increased light-duty vehicle use

²⁶² These estimates were developed by FHWA for use in its 1997 *Federal Highway Cost Allocation Study*.

²⁶³ Federal Highway Administration, 1997 *Federal Highway Cost Allocation Study*, Tables V-22, V-23, and V-24, <http://www.fhwa.dot.gov/policy/hcas/final/index.htm>. The higher congestion cost for automobiles than for light trucks reflects the larger fraction of auto than of light truck use that occurs within congested urban areas.

in the U.S. to be 3.9 and 3.4 cents per vehicle-mile when converted to 2007 dollars.²⁶⁴ These estimates incorporate careful adjustments of congestion and crash costs that are intended to reflect the traffic conditions under which additional driving is likely to take place, as well as its likely effects on both the frequency and severity of motor vehicle crashes.

FHWA's estimates of added costs for congestion, crashes, and noise are multiplied by the estimated increases in passenger car and light truck use due during each year of the affected model years' lifetimes to yield the estimated increases in congestion, crash, and noise externality costs. The resulting yearly estimates are then summed to obtain their lifetime values. The value of these increased costs varies among model years and the alternative increases in CAFE standards considered in this analysis, because the increases in vehicle use depend on the improvements in fuel economy that would result in specific model years under each alternative.

E. The Discount Rate

Discounting future fuel savings and other benefits is intended to account for the reduction in their value to society when they are deferred until some future date, rather than received immediately. The discount rate expresses the percent decline in the value of these benefits – as viewed from today's perspective – for each year they are deferred into the future. In evaluating the benefits from alternative increases in CAFE standards for MY 2012-2016 passenger car and light trucks, NHTSA has employed a discount rate of 3% per year. The agency has also tested the sensitivity of these benefit and cost estimates to the use of a 7 percent discount rate.

The primary reason that NHTSA has selected 3 percent as the appropriate rate for discounting future benefits from increased CAFE standards is that most or all of vehicle manufacturers' costs for complying with higher CAFE standards are likely to be reflected in higher sales prices for their new vehicle models. By increasing sales prices for new cars and light trucks, CAFE regulation will thus primarily affect vehicle purchases and other private consumption decisions. Both economic theory and OMB guidance on discounting indicate that the future benefits and costs of regulations that mainly affect private consumption should be discounted at the social rate of time preference.²⁶⁵

OMB guidance also indicates that savers appear to discount future consumption at an average real (that is, adjusted to remove the effect of inflation) rate of about 3 percent when they face little risk about its likely level, which makes it a reasonable estimate of the social rate of time preference.²⁶⁶ Thus NHTSA has employed the 3 percent rate to discount projected future benefits and costs resulting from higher CAFE standards for MY 2012-2016 passenger cars and light trucks.

²⁶⁴ Ian W.H. Parry and Kenneth A. Small, "Does Britain or the U.S. Have the Right Gasoline Tax?" Discussion Paper 02-12, Resources for the Future, March 2002, pp. 19 and Table 1, <http://www.rff.org/rff/Documents/RFF-DP-02-12.pdf>.

²⁶⁵ *Id.*

²⁶⁶ Office of Management and Budget, Circular A-4, "Regulatory Analysis," September 17, 2003, 33. Available at <http://www.whitehouse.gov/omb/circulars/a004/a-4.pdf> (last accessed July 24, 2009).

Because there is some uncertainty about the extent to which vehicle manufacturers will be able to recover their costs for complying with higher CAFE standards by increasing vehicle sales prices, however, NHTSA has also tested the sensitivity of these benefit and cost estimates to the use of a higher percent discount rate. OMB guidance indicates that the real economy-wide opportunity cost of capital is the appropriate discount rate to apply to future benefits and costs when the primary effect of a regulation is "...to displace or alter the use of capital in the private sector," and estimates that this rate currently averages about 7 percent.²⁶⁷ Thus the agency has also tested the sensitivity of its benefit and cost estimates for alternative MY 2012-2016 CAFE standards to the use of a 7 percent real discount rate. NHTSA seeks comment on whether it should evaluate CAFE standards using a discount rate of 3 percent, 7 percent, or an alternative value.

F. Summary of Values used to Estimate Benefits

Table VIII-9 summarizes the economic values used to estimate benefits.

**Table VIII-9
Economic Values Used for Benefits Computations (2007\$)**

Fuel Economy Rebound Effect	10%
"Gap" between test and on-road MPG	20%
Value of refueling time per (\$ per vehicle-hour)	\$ 24.64
Annual growth in average vehicle use	1.1%
Fuel Prices (2012-50 average, \$/gallon)	
Retail gasoline price	\$3.77
Pre-tax gasoline price	\$3.40
Economic Benefits from Reducing Oil Imports (\$/gallon)	
"Monopsony" Component	\$ 0.00
Price Shock Component	\$ 0.17
Military Security Component	\$ 0.00
Total Economic Costs (\$/gallon)	\$ 0.17
Emission Damage Costs (weighted, \$/ton or \$/metric ton)	
Carbon monoxide	\$ 0
Volatile organic compounds (VOC)	\$ 1,300
Nitrogen oxides (NO _x) – vehicle use	\$ 5,300
Nitrogen oxides (NO _x) – fuel production and distribution	\$5,100
Particulate matter (PM _{2.5}) – vehicle use	\$ 290,000
Particulate matter (PM _{2.5}) – fuel production and distribution	\$ 240,000
Sulfur dioxide (SO ₂)	\$ 31,000
Carbon dioxide (CO ₂)	\$ 20
Annual Increase in CO ₂ Damage Cost	3%

²⁶⁷ *Id.*

External Costs from Additional Automobile Use (\$/vehicle-mile)	
Congestion	\$ 0.054
Accidents	\$ 0.023
Noise	\$ 0.001
Total External Costs	\$ 0.078
External Costs from Additional Light Truck Use (\$/vehicle-mile)	
Congestion	\$0.048
Accidents	\$0.026
Noise	\$0.001
Total External Costs	\$0.075
Discount Rate Applied to Future Benefits	3%

G. Benefits Estimates

Benefits were calculated separately for passenger cars and light trucks under each alternative CAFE requirement for each model year covered by this proposal. In Tables VIII-10 and VIII-11, the societal impacts for passenger car and light truck CAFE standards under the proposed Optimized Net Benefits alternative is shown for model years 2012-2016. These tables include undiscounted values as well as their net present values discounted 3 percent. They also show changes in the physical units of measure that produced these values. Negative values in these tables reflect net reductions in fuel consumption or emissions and their resulting economic impacts, which represent benefits from the proposal, while positive values represent increasing emissions, congestion, noise or crash severity and their added costs. The net social benefit from these societal impacts is shown on the Total line in each table.

The preferred alternative for passenger cars would save 36.2 billion gallons of fuel and prevent 385 million metric tons of tailpipe CO₂ emissions over the lifetime of the passenger cars sold during those model years, compared to the fuel savings and emissions reductions that would occur if the standards remained at the adjusted baseline for MYs 2012-2016. The preferred alternative for light trucks would save 24.9 billion gallons of fuel and prevent 269 million metric tons of tailpipe CO₂ emissions over the lifetime of the light trucks sold during those model years, compared to the fuel savings and emissions reductions that would occur if the standards remained at the adjusted baseline for MYs 2012-2016.

The total value of societal benefits of the preferred alternative for passenger cars and light trucks would be \$200 billion²⁶⁸ over the lifetime of the MY 2012-6 fleet. This estimate of societal benefits includes direct impacts from lower fuel consumption as well as externalities, and also reflects offsetting societal costs resulting from the rebound effect. Fuel savings account for 78 percent and CO₂ emissions account for 8 percent of the societal benefits.

²⁶⁸ The \$200 billion estimate is based on a 3% discount rate for valuing future impacts.

Table VIII-12 and VIII-13 summarizes the societal benefits for all alternatives for passenger cars and light trucks at the 3 percent and 7 percent discount rates, respectively. As would be expected, benefit levels parallel the increasing stringency of the various alternatives that were examined. The TC=TB scenario produces benefits that exceed the other alternatives because that methodology allows technologies that are cost effective to pay for some technologies that are not cost effective. Table VIII-14 summarizes the fuel savings from all alternatives for passenger cars and light trucks.

**Table VIII-10
Lifetime Benefits for Preferred Alternative by Model Year --
Passenger Cars**

MY 2012

Societal Effect	Physical Units	Undiscounted Value	Present Discounted Value @ 3%	Present Discounted Value @ 7%
Lifetime Fuel Expenditures	2,458,057 (kgal)	\$7,330	\$5,936	\$4,689
Consumer Surplus from Additional Driving	6,923,537 (kmiles)	\$532	\$432	\$342
Refueling Time Value	24,444,947 (hours)	\$602	\$497	\$402
Petroleum Market Externalities	2,458,057 (kgal)	\$395	\$326	\$263
Congestion Costs	6,923,537 (kmiles)	-\$371	-\$306	-\$248
Noise Costs	6,923,537 (kmiles)	-\$5	-\$4	-\$3
Crash Costs	6,923,537 (kmiles)	-\$161	-\$133	-\$107
CO2	25 (mmT)	\$733	\$588	\$461
CO	153,775 (tons)	\$0	\$0	\$0
VOC	20,268 (tons)	\$32	\$26	\$21
NOX	12,462 (tons)	\$79	\$59	\$43
PM	569 (tons)	\$164	\$129	\$99
SOX	3,047 (tons)	\$115	\$94	\$76
Total		\$9,446	\$7,644	\$6,037

MY 2013

Societal Effect	Physical Units	Undiscounted Value	Present Discounted Value @ 3%	Present Discounted Value @ 7%
Lifetime Fuel Expenditures	5,339,075 (kgal)	\$16,283	\$13,306	\$10,596
Consumer Surplus from Additional Driving	14,224,351 (kmiles)	\$1,177	\$964	\$770
Refueling Time Value	50,705,079 (hours)	\$1,249	\$1,037	\$841

Petroleum Market Externalities	5,339,075 (kgal)	\$858	\$711	\$576
Congestion Costs	14,224,351 (kmiles)	-\$762	-\$632	-\$513
Noise Costs	14,224,351 (kmiles)	-\$10	-\$8	-\$7
Crash Costs	14,224,351 (kmiles)	-\$330	-\$274	-\$222
CO2	56 (mmT)	\$1,649	\$1,334	\$1,053
CO	211,735 (tons)	\$0	\$0	\$0
VOC	40,197 (tons)	\$64	\$52	\$42
NOX	20,344 (tons)	\$130	\$99	\$73
PM	1,097 (tons)	\$316	\$253	\$198
SOX	6,598 (tons)	\$248	\$206	\$167
Total		\$20,871	\$17,047	\$13,574

MY 2014

Societal Effect	Physical Units	Undiscounted Value	Present Discounted Value @ 3%	Present Discounted Value @ 7%
Lifetime Fuel Expenditures	7,480,899 (kgal)	\$23,351	\$19,140	\$15,297
Consumer Surplus from Additional Driving	20,059,155 (kmiles)	\$1,686	\$1,385	\$1,110
Refueling Time Value	70,603,182 (hours)	\$1,740	\$1,444	\$1,171
Petroleum Market Externalities	7,480,899 (kgal)	\$1,202	\$997	\$808
Congestion Costs	20,059,155 (kmiles)	-\$1,075	-\$892	-\$724
Noise Costs	20,059,155 (kmiles)	-\$14	-\$12	-\$9
Crash Costs	20,059,155 (kmiles)	-\$465	-\$386	-\$313
CO2	79 (mmT)	\$2,403	\$1,945	\$1,536
CO	207,015 (tons)	\$0	\$0	\$0
VOC	52,595 (tons)	\$84	\$69	\$55
NOX	23,660 (tons)	\$151	\$116	\$88
PM	1,530 (tons)	\$440	\$356	\$282
SOX	9,224 (tons)	\$347	\$288	\$233
Total		\$29,849	\$24,450	\$19,533

MY 2015

Societal Effect	Physical Units	Undiscounted Value	Present Discounted Value @ 3%	Present Discounted Value @ 7%
Lifetime Fuel Expenditures	9,351,834 (kgal)	\$29,777	\$24,478	\$19,628
Consumer Surplus from Additional Driving	24,988,963 (kmiles)	\$2,137	\$1,759	\$1,414
Refueling Time Value	88,939,787 (hours)	\$2,191	\$1,820	\$1,477
Petroleum Market Externalities	9,351,834 (kgal)	\$1,502	\$1,247	\$1,011
Congestion Costs	24,988,963 (kmiles)	-\$1,339	-\$1,112	-\$902
Noise Costs	24,988,963 (kmiles)	-\$17	-\$15	-\$12
Crash Costs	24,988,963 (kmiles)	-\$580	-\$481	-\$391
CO ₂	99 (mmT)	\$3,106	\$2,516	\$1,988
CO	195,327 (tons)	\$0	\$0	\$0
VOC	63,482 (tons)	\$101	\$83	\$67
NOX	26,089 (tons)	\$166	\$130	\$99
PM	1,874 (tons)	\$540	\$439	\$350
SOX	11,519 (tons)	\$433	\$360	\$292
Total		\$38,016	\$31,224	\$25,021

MY 2016

Societal Effect	Physical Units	Undiscounted Value	Present Discounted Value @ 3%	Present Discounted Value @ 7%
Lifetime Fuel Expenditures	11,409,671 (kgal)	\$36,922	\$30,421	\$24,456
Consumer Surplus from Additional Driving	30,563,190 (kmiles)	\$2,627	\$2,168	\$1,746
Refueling Time Value	107,962,083 (hours)	\$2,660	\$2,211	\$1,795
Petroleum Market Externalities	11,409,671 (kgal)	\$1,833	\$1,522	\$1,235
Congestion Costs	30,563,190 (kmiles)	-\$1,638	-\$1,361	-\$1,105

Noise Costs	30,563,190 (kmiles)	-\$21	-\$18	-\$14
Crash Costs	30,563,190 (kmiles)	-\$709	-\$589	-\$478
CO2	121 (mmT)	\$3,899	\$3,162	\$2,500
CO	207,306 (tons)	\$0	\$0	\$0
VOC	77,058 (tons)	\$122	\$101	\$81
NOX	30,219 (tons)	\$193	\$151	\$116
PM	2,218 (tons)	\$639	\$523	\$419
SOX	14,053 (tons)	\$529	\$439	\$356
Total		\$47,055	\$38,730	\$31,107

MY 2012-2016, Combined Passenger Cars

Societal Effect	Physical Units	Undiscounted Value	Present Discounted Value @ 3%	Present Discounted Value @ 7%
Lifetime Fuel Expenditures	36,039,535 (kgal)	\$113,663	\$93,281	\$74,666
Consumer Surplus from Additional Driving	96,759,195 (kmiles)	\$8,159	\$6,708	\$5,381
Refueling Time Value	342,655,077 (hours)	\$8,443	\$7,009	\$5,685
Petroleum Market Externalities	36,039,535 (kgal)	\$5,790	\$4,803	\$3,894
Congestion Costs	96,759,195 (kmiles)	-\$5,186	-\$4,305	-\$3,491
Noise Costs	96,759,195 (kmiles)	-\$68	-\$56	-\$46
Crash Costs	96,759,195 (kmiles)	-\$2,245	-\$1,863	-\$1,511
CO2	381 (mmT)	\$11,790	\$9,546	\$7,538
CO	975,158 (tons)	\$0	\$0	\$0
VOC	253,600 (tons)	\$403	\$331	\$266
NOX	112,774 (tons)	\$719	\$556	\$419
PM	7,289 (tons)	\$2,098	\$1,701	\$1,347
SOX	44,442 (tons)	\$1,672	\$1,387	\$1,124
Total		\$145,237	\$119,096	\$95,273

**Table VIII-11
Lifetime Benefits for Preferred Alternative by Model Year --
Light Trucks**

MY 2012

Societal Effect	Physical Units	Undiscounted Value	Present Discounted Value @ 3%	Present Discounted Value @ 7%
Lifetime Fuel Expenditures	1,794,280 (kgal)	\$5,393	\$4,261	\$3,302
Consumer Surplus from Additional Driving	3,985,820 (kmiles)	\$403	\$319	\$248
Refueling Time Value	14,042,208 (hours)	\$346	\$279	\$222
Petroleum Market Externalities	1,794,280 (kgal)	\$288	\$233	\$185
Congestion Costs	3,985,820 (kmiles)	-\$191	-\$154	-\$123
Noise Costs	3,985,820 (kmiles)	-\$4	-\$3	-\$3
Crash Costs	3,985,820 (kmiles)	-\$104	-\$84	-\$66
CO2	19 (mmT)	\$567	\$440	\$336
CO	29,571 (tons)	\$0	\$0	\$0
VOC	12,015 (tons)	\$19	\$15	\$12
NOX	4,689 (tons)	\$30	\$23	\$17
PM	400 (tons)	\$115	\$91	\$71
SOX	2,212 (tons)	\$83	\$67	\$53
Total		\$6,946	\$5,488	\$4,255

MY 2013

Societal Effect	Physical Units	Undiscounted Value	Present Discounted Value @ 3%	Present Discounted Value @ 7%
Lifetime Fuel Expenditures	3,721,906 (kgal)	\$11,461	\$9,090	\$7,075
Consumer Surplus from Additional Driving	7,778,069 (kmiles)	\$854	\$679	\$531
Refueling Time Value	25,811,688 (hours)	\$636	\$514	\$408

Petroleum Market Externalities	3,721,906 (kgal)	\$598	\$483	\$384
Congestion Costs	7,778,069 (kmiles)	-\$373	-\$302	-\$240
Noise Costs	7,778,069 (kmiles)	-\$8	-\$6	-\$5
Crash Costs	7,778,069 (kmiles)	-\$202	-\$163	-\$130
CO2	40 (mmT)	\$1,227	\$953	\$728
CO	-15,336 (tons)	\$0	\$0	\$0
VOC	21,930 (tons)	\$35	\$28	\$23
NOX	6,533 (tons)	\$42	\$33	\$26
PM	804 (tons)	\$232	\$185	\$146
SOX	4,575 (tons)	\$172	\$139	\$111
Total		\$14,672	\$11,633	\$9,057

MY 2014

Societal Effect	Physical Units	Undiscounted Value	Present Discounted Value @ 3%	Present Discounted Value @ 7%
Lifetime Fuel Expenditures	5,418,517 (kgal)	\$17,068	\$13,575	\$10,603
Consumer Surplus from Additional Driving	11,356,621 (kmiles)	\$1,258	\$1,004	\$786
Refueling Time Value	37,865,260 (hours)	\$933	\$754	\$599
Petroleum Market Externalities	5,418,517 (kgal)	\$870	\$703	\$559
Congestion Costs	11,356,621 (kmiles)	-\$545	-\$440	-\$350
Noise Costs	11,356,621 (kmiles)	-\$11	-\$9	-\$7
Crash Costs	11,356,621 (kmiles)	-\$295	-\$239	-\$190
CO2	58 (mmT)	\$1,851	\$1,437	\$1,098
CO	-56,218 (tons)	\$0	\$0	\$0
VOC	30,512 (tons)	\$48	\$39	\$32
NOX	7,461 (tons)	\$48	\$39	\$32
PM	1,146 (tons)	\$330	\$265	\$210
SOX	6,651 (tons)	\$250	\$202	\$161
Total		\$21,805	\$17,331	\$13,533

MY 2015

Societal Effect	Physical Units	Undiscounted Value	Present Discounted Value @ 3%	Present Discounted Value @ 7%
Lifetime Fuel Expenditures	6,795,789 (kgal)	\$21,823	\$17,402	\$13,636
Consumer Surplus from Additional Driving	14,056,381 (kmiles)	\$1,589	\$1,270	\$998
Refueling Time Value	46,672,078 (hours)	\$1,150	\$929	\$738
Petroleum Market Externalities	6,795,789 (kgal)	\$1,092	\$882	\$701
Congestion Costs	14,056,381 (kmiles)	-\$675	-\$545	-\$433
Noise Costs	14,056,381 (kmiles)	-\$14	-\$11	-\$9
Crash Costs	14,056,381 (kmiles)	-\$365	-\$295	-\$235
CO2	73 (mmT)	\$2,396	\$1,860	\$1,422
CO	-98,276 (tons)	\$0	\$0	\$0
VOC	37,303 (tons)	\$59	\$48	\$39
NOX	8,247 (tons)	\$53	\$44	\$36
PM	1,434 (tons)	\$413	\$332	\$263
SOX	8,337 (tons)	\$314	\$253	\$201
Total		\$27,834	\$22,170	\$17,359

MY 2016

Societal Effect	Physical Units	Undiscounted Value	Present Discounted Value @ 3%	Present Discounted Value @ 7%
Lifetime Fuel Expenditures	7,828,744 (kgal)	\$25,539	\$20,402	\$16,022
Consumer Surplus from Additional Driving	16,240,772 (kmiles)	\$1,837	\$1,471	\$1,158
Refueling Time Value	53,530,844 (hours)	\$1,319	\$1,066	\$847
Petroleum Market Externalities	7,828,744 (kgal)	\$1,258	\$1,016	\$808
Congestion Costs	16,240,772 (kmiles)	-\$780	-\$630	-\$501
Noise Costs	16,240,772 (kmiles)	-\$16	-\$13	-\$10

Crash Costs	16,240,772 (kmiles)	-\$422	-\$341	-\$271
CO2	85 (mmT)	\$2,846	\$2,210	\$1,689
CO	-122,086 (tons)	\$0	\$0	\$0
VOC	42,637 (tons)	\$68	\$55	\$44
NOX	9,088 (tons)	\$58	\$49	\$40
PM	1,642 (tons)	\$473	\$381	\$302
SOX	9,602 (tons)	\$361	\$292	\$232
Total		\$32,540	\$25,957	\$20,361

MY 2012-2016, Combined Light Trucks

Societal Effect	Physical Units	Undiscounted Value	Present Discounted Value @ 3%	Present Discounted Value @ 7%
Lifetime Fuel Expenditures	25,559,236 (kgal)	\$81,283	\$64,731	\$50,639
Consumer Surplus from Additional Driving	53,417,662 (kmiles)	\$5,942	\$4,743	\$3,721
Refueling Time Value	177,922,078 (hours)	\$4,384	\$3,541	\$2,815
Petroleum Market Externalities	25,559,236 (kgal)	\$4,106	\$3,318	\$2,637
Congestion Costs	53,417,662 (kmiles)	-\$2,564	-\$2,071	-\$1,647
Noise Costs	53,417,662 (kmiles)	-\$53	-\$43	-\$34
Crash Costs	53,417,662 (kmiles)	-\$1,389	-\$1,122	-\$892
CO2	275 (mmT)	\$8,888	\$6,900	\$5,275
CO	-262,345 (tons)	\$0	\$0	\$0
VOC	144,398 (tons)	\$229	\$187	\$150
NOX	36,019 (tons)	\$230	\$188	\$151
PM	5,427 (tons)	\$1,562	\$1,255	\$992
SOX	31,377 (tons)	\$1,180	\$954	\$758
Total		\$103,797	\$82,580	\$64,564

Table VIII-12
Present Value of Lifetime Social Benefits by Alternative
(millions of 2007 dollars)
(3 percent discount rate)

Alternative	MY 2012	MY 2013	MY 2014	MY 2015	MY 2016	5-Year Total
Passenger Cars						
Preferred Alternative	\$7,644	\$17,047	\$24,450	\$31,224	\$38,730	\$119,096
3% Annual Increase	\$3,367	\$10,578	\$15,652	\$20,197	\$25,962	\$75,757
4% Annual Increase	\$5,141	\$13,815	\$21,529	\$28,652	\$35,639	\$104,777
5% Annual Increase	\$6,915	\$18,010	\$27,995	\$35,592	\$45,265	\$133,777
6% Annual Increase	\$8,277	\$21,197	\$33,429	\$42,482	\$52,972	\$158,358
7% Annual Increase	\$8,916	\$22,921	\$36,032	\$46,015	\$57,389	\$171,274
Max Net Benefits	\$8,729	\$22,621	\$34,854	\$43,948	\$52,512	\$162,664
Total Cost = Total Benefit	\$9,698	\$24,214	\$37,157	\$46,624	\$57,050	\$174,744
Light Trucks						
Preferred Alternative	\$5,488	\$11,633	\$17,331	\$22,170	\$25,957	\$82,580
3% Annual Increase	\$1,969	\$5,129	\$9,274	\$13,511	\$16,418	\$46,301
4% Annual Increase	\$3,311	\$8,831	\$15,127	\$20,341	\$23,818	\$71,429
5% Annual Increase	\$4,228	\$11,526	\$20,010	\$26,902	\$31,342	\$94,009
6% Annual Increase	\$4,906	\$14,146	\$24,100	\$32,895	\$37,996	\$114,044
7% Annual Increase	\$6,129	\$16,401	\$27,520	\$36,714	\$41,708	\$128,471
Max Net Benefits	\$8,533	\$19,661	\$28,851	\$35,538	\$37,908	\$130,491
Total Cost = Total Benefit	\$8,738	\$20,213	\$30,142	\$37,736	\$40,924	\$137,752

Table VIII-13
Present Value of Lifetime Social Benefits by Alternative
(millions of 2007 dollars)
(7 percent discount rate)

Alternative	MY 2012	MY 2013	MY 2014	MY 2015	MY 2016	5-Year Total
Passenger Cars						
Preferred Alternative	\$6,037	\$13,574	\$19,533	\$25,021	\$31,107	\$95,273
3% Annual Increase	\$2,655	\$8,433	\$12,510	\$16,195	\$20,868	\$60,660
4% Annual Increase	\$4,066	\$11,021	\$17,222	\$22,985	\$28,647	\$83,941
5% Annual Increase	\$5,455	\$14,344	\$22,364	\$28,521	\$36,356	\$107,039
6% Annual Increase	\$6,541	\$16,892	\$26,708	\$34,041	\$42,544	\$126,726
7% Annual Increase	\$7,048	\$18,271	\$28,797	\$36,871	\$46,095	\$137,083
Max Net Benefits	\$6,769	\$17,911	\$27,635	\$34,638	\$41,105	\$128,058
Total Cost = Total Benefit	\$7,670	\$19,304	\$29,703	\$37,371	\$45,830	\$139,878
Light Trucks						
Preferred Alternative	\$4,255	\$9,057	\$13,533	\$17,359	\$20,361	\$64,564
3% Annual Increase	\$1,527	\$3,996	\$7,243	\$10,581	\$12,880	\$36,227
4% Annual Increase	\$2,568	\$6,879	\$11,813	\$15,926	\$18,682	\$55,868
5% Annual Increase	\$3,273	\$8,957	\$15,603	\$21,040	\$24,565	\$73,437
6% Annual Increase	\$3,798	\$10,996	\$18,784	\$25,688	\$29,737	\$89,003
7% Annual Increase	\$4,745	\$12,748	\$21,450	\$28,669	\$32,639	\$100,251
Max Net Benefits	\$6,611	\$15,227	\$22,245	\$27,534	\$29,885	\$101,501
Total Cost = Total Benefit	\$6,769	\$15,710	\$23,492	\$29,462	\$32,020	\$107,453

Table VIII-14
Fuel Savings over Lifetimes of Model Year 2012-2016 Passenger Cars
and Light Trucks with Alternative Increases in CAFE Standards
(million gallons)

Passenger Cars						
Alternative	MY 2012	MY 2013	MY 2014	MY 2015	MY 2016	Total
Preferred Alternative	2,458	5,339	7,481	9,352	11,410	36,040
3% Annual Increase	1,093	3,315	4,792	6,047	7,640	22,886
4% Annual Increase	1,664	4,331	6,592	8,585	10,500	31,672
5% Annual Increase	2,222	5,635	8,559	10,654	13,335	40,405
6% Annual Increase	2,662	6,647	10,240	12,748	15,639	47,936
7% Annual Increase	2,869	7,187	11,037	13,806	16,944	51,844
Max Net Benefits	2,809	7,095	10,676	13,184	15,499	49,263
Total Cost = Total Benefit	3,122	7,595	11,382	13,988	16,841	52,928
Light Trucks						
Alternative	MY 2012	MY 2013	MY 2014	MY 2015	MY 2016	Total
Preferred Alternative	1,794	3,722	5,419	6,796	7,829	25,559
3% Annual Increase	646	1,643	2,900	4,139	4,947	14,276
4% Annual Increase	1,087	2,831	4,736	6,238	7,186	22,079
5% Annual Increase	1,358	3,657	6,230	8,213	9,424	28,882
6% Annual Increase	1,580	4,501	7,502	10,006	11,382	34,970
7% Annual Increase	1,976	5,219	8,571	11,174	12,498	39,437
Max Net Benefits	2,777	6,270	8,991	10,847	11,379	40,263
Total Cost = Total Benefit	2,844	6,446	9,396	11,486	12,256	42,428

References

- Argonne National Laboratories, The Greenhouse Gas and Regulated Emissions from Transportation (GREET) Model, Version 1.6, February 2002.
- Greene, David L., "Vehicle Use and Fuel Economy: How Big is the Rebound Effect?" *The Energy Journal*, 13:1 (1992), 117-143.
- Greene, David L., Donald W. Jones, and Paul N. Leiby, *The Outlook for U.S. Oil Dependence*, ORNL-6873, Oak Ridge National Laboratory, May 11, 1995.
- Greene, David L., James R. Kahn, and Robert C. Gibson, "Fuel Economy Rebound Effect for Household Vehicles," *The Energy Journal*, 20:3 (1999), 1-31.
- Greene, David L., and Nataliya I. Tishchishyna, *Costs of Oil Dependence: A 2000 Update*, ORNL/TM-2000/152, Oak Ridge National Laboratory, May 2000.
- Houghton, Jonathan, and Soumodip Sarkar, "Gasoline Tax as a Corrective Tax: Estimates for the United States," *The Energy Journal*, 17:2, 103-126.
- Jones, Clifton T., "Another Look at U.S. Passenger Vehicle Use and the 'Rebound' Effect from Improved Fuel Efficiency," *The Energy Journal*, 14:4 (1993), 99-110.
- Leiby, Paul N., Donald W. Jones, T. Randall Curlee, and Russell Lee, *Oil Imports: An Assessment of Benefits and Costs*, ORNL-6851, Oak Ridge National Laboratory, November 1, 1997.
- Pickrell, Don H., "Description of VMT Forecasting Procedure for 'Car Talk' Base Line Forecasts," manuscript, Volpe National Transportation Systems Center, U.S. Department of Transportation, 1994.
- Puller, S.L., and L.A. Greening, "Household Adjustment to Gasoline Price Changes: An Analysis Using Nine Years of U.S. Survey Data," *Energy Economics*, 21:1, pp. 37-52.
- Small, K.A. and VanDender, K. (2005) "A Study to Evaluate the Effect of Reduced Greenhouse Gas Emissions on Vehicle Miles Traveled", State of California Air Resources Board, California Environmental Protection Agency, and the California Energy Commission.
- U.S. Department of Energy, Program Analysis Methodology Office of Transportation Technology: Quality Metrics 2002, Final Report, Office of Transportation Technologies, May 9, 2001.
- U.S. Environmental Protection Agency, MOBILE Motor Vehicle Emission Factor Model, version 6.2, November 2002

IX. IMPACT OF WEIGHT REDUCTION ON SAFETY

Vehicle Weight, Size and Safety

For many years, there has been a controversy over the relative effect of vehicle size versus vehicle weight on vehicle safety. With each fuel economy rulemaking, the debate continues.²⁶⁹ The following discussion provides NHTSA's point of view.

Other things being equal, smaller and lighter vehicles provide less protection to their occupants in the event of a crash because there is less vehicle structure (i.e., crush space) to absorb the crash energy and less interior space in which air bags can safely decelerate occupants. In addition, smaller and lighter vehicles are generally more likely to be involved in crashes in which they run off the road or roll over.

In single vehicle crashes, smaller and lighter vehicles are less safe than larger and heavier vehicles. For example, if a car hits a small to medium tree, having more weight might enable the car to knock that tree down and thus reduce both the delta V of the vehicle and its occupants and thus the decelerative forces experienced by the occupants. Likewise, having more interior space gives the air bags more space in which to allow the occupants to ride down the crash forces.

In multi-vehicle crashes, both individual vehicle size and the relative mass of the involved vehicles have a relationship with crash involvement rates and with the injury outcome of occupants of both vehicles. Generally, larger and heavier vehicles are less involved in crashes and provide better protection for their own occupants when they do become involved in crashes, but often at the expense of occupants of smaller vehicles they strike. If larger vehicles were to be reduced in size and mass, it would likely decrease the chance or severity of injury to the occupants of the other vehicle in crashes with smaller vehicles, but it would also likely increase the chance or severity of injury for the occupants of the larger vehicles because the latter vehicles would lose some of their weight advantage vis-à-vis the smaller vehicles. It might also increase crash-involvement rates of the larger vehicles.

The overall impact of reducing vehicle size and mass on injuries in multi-vehicle crashes could vary, depending on how the vehicle-size mix shifts in the future, but any weight reduction is likely to increase the injury risk for vehicle occupants in single vehicle crashes, which represent 30 percent of all crashes and account for 57 percent of all fatalities (See Appendix A for more detail about the impact of weight reduction on the outcomes of specific types of crashes).

In general, it is unclear how much of the higher risk of smaller and lighter vehicles is associated with their reduced mass and how much with their reduced physical dimensions. That is because, historically, the safest vehicles have been heavy and large, while the vehicles with the highest fatal-crash rates have been light and small. Intuitively, reducing mass, while maintaining physical dimensions, is likely to be less harmful than reducing both mass and physical dimensions. However, in single vehicle crashes, the law of physics will still apply. Vehicles that are lightened (whether by downsizing or material substitution) will be less safe when hitting objects off the road. An attribute based system based on footprint will require improvements in

²⁶⁹ See, e.g., chapter IV of the Final Regulatory Impact Analysis for the MY 2011 Passenger Car and Light Truck CAFE Standards, March 2009.

fuel economy for all vehicle sizes, and will minimize incentives to downsize the central core of vehicles, i.e., the footprint.²⁷⁰ There may be incentives for consumers to demand smaller vehicles (e.g., an increase in the price of gasoline), but those external factors would not be influenced by the final rule structure.

Neither the CAFE standards nor our analysis mandates either weight reduction or any specific technology application. However, weight reduction is one of the technology applications available to manufacturers and is used by the VOLPE model to aid in determining the capabilities of manufacturers and in predicting both cost and fuel consumption impacts of higher CAFE standards. In this section, we analyze the potential impacts of these weight reductions on vehicle safety.

We first present a recent historical perspective of the debate:

NHTSA must understand the relationship between vehicle factors and safety, both for establishing our safety standards and for establishing our CAFE standards. In July 1991, NHTSA published a study of the effects of passenger car downsizing during 1970-1982 titled *Effect of Car Size on Fatality and Injury Risk*. In this report, NHTSA concluded that changes in the size and weight composition of the new car fleet from 1970 to 1982 resulted in increases of nearly 2,000 deaths and 20,000 serious injuries per year over the number of deaths and serious injuries that would have occurred absent this downsizing.

Parties reviewing NHTSA's 1991 report identified a number of areas that could be improved. Suggestions included extending the analyses to include light trucks and vans, examining finer gradations to distinguish the relative impacts of weight reduction for the heavier cars versus those for the lighter cars, analyzing all crash modes, and doing more to isolate the effects of vehicle mass from behavioral and environmental variables.

NHTSA agreed that accommodating these suggestions would make the study more useful as a tool for NHTSA decisions on safety and fuel economy standards. Accordingly, NHTSA developed a more comprehensive analytic model to encompass all light vehicles, and to allow a finer look at safety impacts in different segments of the light vehicle population.

The study produced through the use of this model was NHTSA's first effort to estimate the effect of a 100-pound weight reduction in each of the important crash modes, and to do this separately for cars and light trucks. NHTSA recognized that the findings, whatever they were, would likely be controversial, so the agency chose to have the draft report peer-reviewed by the National Academy of Sciences before publishing the document. The Academy published its review on June 12, 1996.²⁷¹ The report expressed concerns about the methods used in the analyses and concluded, in part, "the Committee finds itself unable to endorse the qualitative conclusions in the reports about projected highway fatalities and injuries because of large uncertainties associated with the results. . ." These reservations were principally concerned with

²⁷⁰ Vehicle footprint is not synonymous with vehicle size. Since the footprint is only that portion of the vehicle between the front and rear axles, footprint based standards do not discourage downsizing the portions of a vehicle in front of the front axle and to the rear of the rear axle (front overhang and rear overhang, respectively) or the portions of a vehicle outside of the centerlines of the wheels (side overhang). 49 CFR 523.2 The crush spaces provided by those portions of a vehicle make important contributions to managing crash energy.

²⁷¹ Transportation Research Board, Letter Report – Committee to Review Federal Estimates of the Relationship of Vehicle Weight to Fatality and Injury Risk, Accession Number 00723787. See <http://onlinepubs.trb.org/onlinepubs/reports/letrept.html> (last accessed Nov. 11, 2008).

the question of whether the NHTSA analyses had adequately controlled for confounding factors, such as driver age, gender, and aggressiveness.

NHTSA responded at length to the committee report, and revised its report to address the committee recommendations. The revised report was published as a finished document in 1997,²⁷² with a new Appendix F titled “Summary and Response to TRB’s Recommendations on the Draft Report.”

In this 1997 report, NHTSA concluded that, calibrated from 1985-93 cars and light trucks involved in crashes in calendar years 1989-1993, there was little overall effect for a 100-pound weight reduction in light trucks and vans, because increased fatalities of truck occupants were offset by a reduction of fatalities in the vehicles that collided with the lighter trucks, whereas a 100-pound reduction in cars was associated with an increase of about 300 fatalities per year. Based on this analysis and subsequent activities, the safety consequences of weight reduction have been considered by NHTSA in deciding upon the appropriate stringency of each of the new safety and fuel economy requirements since that time.

NHTSA’s 1997 report did not end the public discussion of this issue. NHTSA followed its standard practice of publishing a notice announcing the report and inviting public comment on the 1997 report.²⁷³ In addition to comments to NHTSA’s docket, other papers analyzing the relationship of vehicle weight and safety were published. For instance, Dr. David L. Greene of the U.S. Department of Energy’s Oak Ridge National Laboratory published a report titled *Why CAFE Worked* soon after NHTSA’s 1997 report was released.²⁷⁴ In section 5.2 of this report, Dr. Greene’s introductory paragraph reads as follows:

Vehicle weight significantly affects the safety of the vehicle’s occupants. Enough credible work has been done on this subject that this assertion cannot be seriously questioned (citations omitted). On the other hand, the nature of the trade-off between vehicle mass and safety is often misunderstood, and the implications for fuel economy regulations are generally misinterpreted. The relationship between fuel economy, mass, and public safety is complex, yet it is probably reasonable to conclude that reducing vehicle mass to improve fuel economy will require some trade-off with safety. The rational person will realize that individuals, manufacturers, and governments are constantly making trade-offs between safety and cost, safety and other vehicle attributes, safety and convenience, etc. (citation omitted). An essential feature of a rational economic consumer is the willingness to trade-off risk for money and, since fuel economy saves money, to trade-off safety for fuel economy.

David L. Greene, 1997, *Why CAFE Worked*, ORNL/CP-94482, Oak Ridge National Laboratory, Oak Ridge, Tennessee, at 22 (Emphases added).

It is noteworthy that Dr. Greene’s published work explicitly acknowledges the vehicle weight-safety trade-off documented by NHTSA’s studies of the real world crash data. As to Dr. Greene’s concerns that the trade-off will be misunderstood, NHTSA has been clear on this point. NHTSA wants to ensure that the public, manufacturers, and governments are aware of the

²⁷² Kahane, C. J., 1997. Relationships Between Vehicle Size and Fatality Risk in Model Year 1985-93 Passenger Cars and Light Trucks, NHTSA Technical Report, DOT HS 808 570. This report is available online at <http://www-nrd.nhtsa.dot.gov/Pubs/808570.PDF>.

²⁷³ See 62 FR 34491 (June 26, 1997).

²⁷⁴ Dr. Greene’s report is available online at <http://www.osti.gov/bridge/servlets/purl/625225-KPQDOu/webviewable/625225.pdf> (last accessed October 28, 2008).

empirical data that demonstrate that there is a trade-off between vehicle mass and safety. Parties must understand this trade-off exists and the size of the trade-off should be quantified as accurately as possible, so it can be considered as part of the decision on average fuel economy standards.

2. The 2002 National Academy of Sciences Study

The next significant event in the vehicle weight and safety discussion began in October 2000, when the Department of Transportation's Appropriations Act for fiscal year 2001 was signed into law. That appropriations law included a provision directing DOT to fund a National Academy of Sciences (NAS) study on the effectiveness and impacts of CAFE standards. NAS released its final study in January 2002 (hereafter, the 2002 NAS Report).²⁷⁵

As part of a comprehensive look at the impacts of CAFE standards, it was necessary for the 2002 NAS Report to address the safety impacts of CAFE standards. In Chapter 2 of the study, NAS looked back at the safety impacts of past CAFE standards. Among other observations, NAS recognized that much of the increase in fuel economy between 1975 and 1988 was due to reductions in the size and weight of vehicles, which led to increased safety risks.²⁷⁶ In fact, NAS noted

The preponderance of evidence indicates that this downsizing of the vehicle fleet resulted in a hidden safety cost, namely travel safety would have improved even more had vehicles not been downsized.²⁷⁷

The committee then focused its analysis on the 1997 NHTSA analysis led by Dr. Kahane. Since there are many published papers on this subject in the literature, the question must be asked, "Why did the National Academy of Sciences choose the NHTSA analyses out of all the published papers?" The NAS committee clearly and unequivocally answered this in its report, where it found that "NHTSA's fatality analyses are still the most complete available in that they accounted for all crash types in which vehicles might be involved, for all involved road users, and for changes in crash likelihood as well as crashworthiness."²⁷⁸ The NAS committee went on to find that "The April 1997 NHTSA analyses allow the committee to reestimate the approximate effect of downsizing the fleet between the mid-1970s and 1993." In other words, a committee of the National Academy of Sciences found that NHTSA's analyses were the most thorough of all the published papers, and that NHTSA's analyses were sufficiently persuasive and rigorous to permit a reasonable estimate of the safety penalty associated with downsizing the fleet. In the committee's words:

Thus, the majority of this committee believes that the evidence is clear that past downweighting and downsizing of the light-duty vehicle fleet, while resulting in significant fuel savings, has also resulted in a safety penalty. In 1993, it would appear that the safety penalty included between 1,300 and 2,600 motor vehicle crash deaths that would not have occurred had vehicles been as large and heavy as in 1976.²⁷⁹

While this look back is informative, the greater challenge is to use this understanding of the past to guide future actions. Again the NAS committee offered clear guidance in this regard. The NAS Report said:

²⁷⁵ *Effectiveness and Impact of Corporate Average Fuel Economy (CAFE) Standards* (NRC, 2002).

²⁷⁶ *Id.*, at 24.

²⁷⁷ *Id.*, at 69-70.

²⁷⁸ *Id.*, at 27.

²⁷⁹ *Id.*, at 28.

In summary, the majority of the committee finds that the downsizing and weight reduction that occurred in the late 1970s and early 1980s most likely produced between 1,300 and 2,600 crash fatalities and between 13,000 and 26,000 serious injuries in 1993. The proportion of these casualties attributable to CAFE standards is uncertain. It is not clear that significant weight reduction can be achieved in the future without some downsizing, and similar downsizing would be expected to produce similar results. *Even if weight reduction occurred without any downsizing, casualties would be expected to increase.* Thus, any increase in CAFE as currently structured could produce additional road casualties, unless it is specifically targeted at the largest, heaviest light trucks.

For fuel economy regulations not to have an adverse impact on safety, they must be implemented using more fuel-efficient technology. Current CAFE requirements are neutral with regard to whether fuel economy is improved by increasing efficiency or by decreasing vehicle weight. One way to reduce the adverse impact on safety would be to establish fuel economy requirements as a function of vehicle attributes, particularly vehicle weight (see Chapter 5). . . .

*If an increase in fuel economy is effected by a system that encourages either downweighting or the production and sale of more small cars, some additional traffic fatalities would be expected. Without a thoughtful restructuring of the program, that would be the trade-off that must be made if CAFE standards are increased by any significant amount.*²⁸⁰

(Emphasis added.)

This discussion by the NAS committee was an impetus for NHTSA to use its existing statutory authority to reform its light truck CAFE program. This involved moving away from the single flat standard for light trucks, because those standards' neutrality with regard to decreasing vehicle size/weight, in lieu of increasing efficiency to improve fuel economy, means they necessarily have a potential safety trade-off. In place of the single flat standard, NHTSA established an attribute-based standard that is a function of the vehicle's footprint. Under this attribute-based standard, the fuel economy target for a vehicle increases as the vehicle footprint is downsized. As long as vehicle manufacturers have to expend funds for the same levels of advanced technology for each footprint size, there is no incentive to change the vehicle to get a less-demanding fuel economy target. Thus, the necessary safety trade-off under the single flat standard system is much less likely to arise under an attribute-based system.²⁸¹ That is not to suggest there are no safety consequences if vehicle mass is reduced – there are, as documented by NHTSA and explained by the National Academy of Sciences. However, the standards are no longer structured to confer an advantage to a manufacturer that makes footprint downsizing trade-offs. This is a key feature of the attribute-based fuel economy program NHTSA implemented for light trucks.

Two of the 13 NAS committee members dissented on the safety issues.²⁸² The dissent acknowledges that, “Despite these limitations, Kahane’s analysis is far and away the most comprehensive and thorough analysis” of the safety issue.²⁸³ The dissent’s primary

²⁸⁰ *Id.*, at 77.

²⁸¹ As noted above, while use of the footprint based approach substantially reduces the incentive to reduce footprint, it does not inhibit the reduction of front, rear or side overhang. The overhangs provide valuable crush space for managing and reducing the crash forces experienced by vehicle occupants.

²⁸² One of the two dissenters was Dr. David Greene, the author of the 1997 report *Why CAFE Worked*, discussed *supra*.

²⁸³ *Effectiveness and Impact of Corporate Average Fuel Economy (CAFE) Standards*, at 118.

disagreement with the other 11 committee members centers on the large uncertainties associated with NHTSA's analyses. The dissent acknowledges NHTSA's efforts in the study led by Dr. Kahane to quantify the safety penalty, but concludes that the number of factors in real world crashes is so large and the controls used by the analytical models introduce so much uncertainty that it is not possible to definitively make any statements about a safety penalty.²⁸⁴

The majority of the committee responded to the dissent by saying:

However, the committee does not agree that these concerns should prevent the use of NHTSA's careful analyses to provide some understanding of the likely effects of future improvements in fuel economy, if those improvements involve vehicle downsizing. The committee notes that many of the points raised in the dissent (for example, the dependence of the NHTSA results on specific estimates of age, sex, aggressive driving and urban vs. rural location) have been explicitly addressed in Kahane's response to the [NAS] review and were reflected in the final 1997 report. The estimated relationship between mass and safety were (sic) remarkably robust in response to changes in the estimated effects of these parameters. The committee also notes that the most recent NHTSA analyses yield results that are consistent with the agency's own prior estimates of the effect of vehicle downsizing (citations omitted) and with other studies of the likely effects of weight and size changes in the vehicle fleet (citation omitted). The consistency over time and methodology provides further evidence of the robustness of the adverse safety effects of vehicle size and weight reduction.²⁸⁵

In addition, the NAS Committee unanimously agreed that NHTSA should undertake additional research on the subject of fuel economy and safety, "including (but not limited to) a replication, using current field data, of its 1997 analysis of the relationship between vehicle size and fatality risk."²⁸⁶ NHTSA concurred with this recommendation, and thereafter, NHTSA undertook a replication of the 1997 study, using the additional field data that had become available: NHTSA's 2003 study, led again by Dr. Kahane.

As Congress was developing the bill that ultimately became EISA, Congress considered NHTSA's reformed light truck CAFE program established under existing NHTSA authority in deciding what additional CAFE authority NHTSA should be given and what constraints should be put on that authority. Ultimately, EISA was enacted, which mandates that NHTSA establish an attribute-based CAFE system for cars and light trucks.

3. NHTSA's Updated 2003 Study

In October 2003, NHTSA published its updated study.²⁸⁷ NHTSA's update again used regression models to calibrate crash fatality rates per billion miles for model year 1991-1999 passenger cars, pickup trucks, SUVs, and vans during calendar years 1995-2000. These rates were calibrated separately by vehicle weight, vehicle type, driver age and gender, urban/rural and other vehicle, driver, and environmental factors. One major point of note is that, as the analyses get more sophisticated and able to differentiate the safety trade-off among different types of

²⁸⁴ 2002 NAS Report, at Appendix A.

²⁸⁵ *Id.*, at 27-28.

²⁸⁶ *Id.*, at 6.

²⁸⁷ Charles J. Kahane, "Vehicle Weight, Fatality Risk, and Crash Compatibility of Model Year 1991-99 Passenger Cars and Light Trucks," DOT HS 809 662, October 2003. This report is available online at <http://www-nrd.nhtsa.dot.gov/Pubs/809662.PDF>.

vehicles, each analysis NHTSA has ever conducted continues to show that there is a safety trade-off for the existing light vehicle fleet as vehicle mass is reduced.

After controlling for vehicle, driver and environmental factors, the new study found that:

- The association between vehicle weight and overall crash fatality rates in the heavier 1991-1999 light trucks and vans was not significant. Thus, there was no safety penalty for reducing weight in these vehicles.
- In the other three groups of 1991-1999 vehicles – the lighter light trucks and vans, the heavier cars, and especially the lighter cars – fatality rates increased as weights decreased.
 - Lighter light trucks and vans would have an increase of 234 fatalities per year per 100-pound weight reduction.
 - Heavier cars would have an increase of 216 fatalities per year per 100-pound weight reduction.
 - Lighter cars would have an increase of 597 fatalities per year per 100-pound weight reduction.
- There is a crossover weight, above which crash fatality rates increase for heavier light trucks and vans, because the added harm for other road users from the additional weight exceeds any benefits for the occupants of the vehicles. This occurs in the interval of 4,224 pounds to 6,121 pounds, with the most likely single point being 5,085 pounds. The fatality rate changes by less than ± 1 percent per 100-pound weight increase over this range.

The draft report was reviewed before publication by experts in statistical analysis of crash data and related vehicle weight and safety issues: Drs. James H. Hedlund, Adrian K. Lund, and Donald W. Reinfurt. The review process is on record – the comments on the draft are available in Docket NHTSA-2003-16318-0004. Consistent with NHTSA’s standard practice, NHTSA published its analysis and sought public comment on it.²⁸⁸ NHTSA then docketed a response to the public comments on November 9, 2004.²⁸⁹ There were three principal criticisms of NHTSA’s updated study, which are summarized below together with NHTSA’s responses to each.

Criticism one: The analyses only considered the relationship of vehicle mass to fatality risk. It did not consider other attributes of vehicle size, such as track width and wheelbase. Dynamic Research Inc. (DRI) presented analyses that included all three of these variables, and its analysis indicated that mass was harmful (*i.e.*, reducing it would be positive for safety) while track width and wheelbase were beneficial. If true, this meant that weight reduction would benefit safety if track width and wheelbase were maintained.

Agency response: The DRI results were strongly biased as a consequence of including 2-door cars in the analysis. Two-door muscle and sports cars stand apart from all other groups of cars by having a short wheelbase relative to their weight. They also have by far the highest fatality rates of all cars, for reasons mostly related to the drivers. The regression analysis immediately identifies short wheelbase with high weight as a disastrous combination. Being a regression, it tells you that you can make any car safer, including 4-door cars, by increasing wheelbase and/or reducing weight. This bias is amplified by treating highly correlated size attributes as independent factors in the model.

²⁸⁸ See 68 FR 66153 (Nov. 5, 2003).

²⁸⁹ Docket No. NHTSA-2003-16318-0016.

To clarify this latter concern, NHTSA's analyses are calibrating the historical relationship of vehicle mass and fatality risk. In this type of analysis, "vehicle mass" incorporates not only the effects of vehicle mass *per se*, but also the effects of many other size attributes that are historically and/or causally related to mass, such as wheelbase, track width, and structural integrity. If historical relationships between mass and these other size attributes continue, future changes in mass will continue to be associated with similar changes in fatality risk. If the historical relationships change, one will be able to analyze the mass and size attributes independently, but it will take some years to get such data.

However, as a check of DRI's suggestion that mass was not as significant as track width and wheelbase, NHTSA ran both its 1997 and 2003 analyses of 4-door cars only with mass, track width, and wheelbase as separate variables. When we did this, we saw that mass continued to have a substantial effect, even independent of track width and wheelbase in all crash modes except rollovers. In fact, only curb weight had a consistent, significant effect in both the data sets used in NHTSA's 1997 analyses and his 2003 analyses. This was publicly reported over four years ago, in NHTSA's November 2004 response to the comments on his 2003 analyses.

After considering the DRI submission, NHTSA made no change to the findings in its 2003 report.

Criticism two: Marc Ross, of the University of Michigan, and Tom Wenzel, of Lawrence Berkeley National Laboratory, commented that vehicle "quality" has a much stronger relationship with fatality risk than vehicle mass. They suggest that lighter cars have a higher fatality risk on average because they are usually the least expensive cars and, in many cases, the "poorest quality" cars. If true, weight reduction is fairly harmless, as long as the lighter cars are of the same "quality" as the heavier cars they replace.

Agency response: In their analyses, Ross and Wenzel did not adjust their rates for driver age and gender. Absent those adjustments, the analysis mingles the effects of what sort of people buy and drive the car with the intrinsic safety of the car, making its conclusions about the intrinsic safety of the car suspect, at best. On average, and considering all crash modes as well as both weight groups of cars, controlling for price has little effect on the weight-safety coefficients in NHTSA's analyses. As a final check, NHTSA ran an analysis of head-on collisions of two 1991-99 cars, since this is a pure measure of the vehicle's performance. The results were that the more expensive vehicle's driver had a slightly *higher* fatality risk than the less expensive vehicle's driver, although the difference was not statistically significant. This indicates that the lower fatality rates for more expensive cars in Ross and Wenzel's study are not due to expensive cars' superior performance in crashes.

Accordingly, NHTSA determined the Ross and Wenzel comment did not warrant a change in NHTSA's report.

Criticism three: The Alliance of Automobile Manufacturers, DaimlerChrysler, William E. Wecker Associates, and Environmental Defense all question the accuracy and robustness of the report's calculation of a "crossover weight," above which weight reductions have a net benefit, instead of harm. NHTSA's report said that this crossover point occurs somewhere in the range of 4,224 pounds to 6,121 pounds (this is the "interval estimate"); with the most likely location of the crossover point at 5,085 pounds (this is the "point estimate"). Wecker suggested that NHTSA's interval estimate of from 4,224 to 6,121 pounds only takes sampling error into account. Wecker identified additional factors that it believed make this estimate not robust, and suggests that the interval estimate should be wider. The Alliance and DaimlerChrysler suggested that the crossover weight could be substantially greater than 5,085 pounds, in which case weight

reductions for light trucks and vans in the 5-6,000 pound range would have detrimental net effects on safety. Conversely, Environmental Defense believes the crossover weight is well below 5,085 pounds, in which case there would be opportunities to reduce vehicle mass in many light trucks and vans without any safety penalty.

Agency response: While NHTSA's report estimates the crossover weight, the report expressly acknowledged the uncertainty about the exact location of the crossover weight. That is why the report highlighted the interval estimate, instead of the point estimate. It is important to note that the net weight-safety relationship remains close to zero for many hundreds of pounds above and below the point estimate for the crossover weight. As shown on pages 163-166 of NHTSA's 2003 report, the crash fatality rate changes by less than ± 1 percent per 100-pound weight increase over a 1,200 pound range on either side of the point estimate for the crossover weight. The data and analysis in the report will not show a statistically significant relationship, in either direction, between weight and safety for the heavier light trucks and vans. That is the important information the report puts in front of the decision maker – i.e., the robust relationship between weight and safety that exists for most vehicles does not exist for the heavier light trucks and vans. With the available data, one cannot develop a precise point estimate for this crossover weight.

Thus, NHTSA determined that its report did not require changes in response to these comments.

4. Summary of Studies Prior to this Rulemaking

Several important observations can be made based on the various studies performed in the years preceding this rulemaking on the relationship between safety and vehicle weight in the context of fuel economy:

1. The question of the effect of weight on vehicle safety is a complex question that poses serious analytic challenges. The issue has been addressed in the literature for more than two decades.
2. NHTSA has been actively engaged in this discussion.
3. All of NHTSA's analyses have found that there is a strong correlation between vehicle mass and vehicle safety for cars and light trucks, up to a certain weight range.
 - a. Given the historic fact that vehicles have been made primarily of steel, there are a number of other parameters that are highly correlated with vehicle mass. These factors include vehicle size (*e.g.*, track width and wheelbase).
 - b. The precise weight point at which the safety penalty ends is difficult to pinpoint, because the fatality rate curve is so flat at that point. NHTSA can say with high confidence that the crossover point is in the range of 4,224 to 6,121 pounds. There are safety penalties for reductions of weight below this crossover weight. There is no reduced societal safety for reducing weight on vehicles that weigh more than this crossover point, because the reduced risk for other road users would exceed any reduced benefits for the occupants of the heavy vehicle.
4. The National Academy of Sciences has twice peer-reviewed NHTSA's work in this area. The 2002 NAS Report found that there was a safety penalty for reducing weight in all but the heaviest light trucks. The study stated that "the downsizing and weight reduction that occurred in the late 1970s and early 1980s most likely produced between 1,300 and 2,600 crash fatalities in 1993."
 - a. Neither the Academy nor NHTSA is suggesting that all of the downsizing and weight reduction were a direct response to the CAFE standards. It is difficult to

objectively quantify what amount of downsizing was a response to CAFE standards, and what was a response to other real or perceived market forces. However, the Academy stated that some of the downsizing was in response to CAFE standards.

- b. NHTSA does not accord the safety dissent, which represented the views of two of the 13 committee members, the same stature as the views expressed in the body of the report, which represents the views of 11 of the 13 committee members.
5. In response to the National Academy's unanimous 2002 recommendation, NHTSA updated its previous work on weight and safety in 2003 to reflect the most recent data. This update found that the trends were similar, and if anything the safety penalty was now higher for reducing weight in small cars. This update also found that there is a crossover weight, which occurs somewhere between 4,264 and 6,121 pounds, with a point estimate at 5,085 pounds, above which there is no safety penalty for reducing vehicle weight. This is because the added harm for other road users from the additional weight exceeds any benefits for the occupants of the vehicles. NHTSA embodied this finding in its CAFE rulemaking by restricting materials substitution in its development of stringency levels to vehicles over 5,000 pounds.
 6. NHTSA published its update and asked for public comments on the updated document.
 7. In response to the request for comments, NHTSA received two recent studies to review. After reviewing these studies, NHTSA concluded that both studies had inadvertently introduced significant biases in their analyses. NHTSA made public its review of these studies in November 2004.
 - a. One of these studies was a 2002 study by DRI that purported to analyze mass, track width, and wheelbase as independent variables. DRI's 2002 paper indicated that reducing mass would be beneficial, while reducing track width and wheelbase would be harmful. If true, this meant that weight reduction would benefit safety if track width and wheelbase were maintained. As discussed above, NHTSA concluded that the DRI results were strongly biased as a consequence of including 2-door cars in the analysis and explained why this was so.²⁹⁰
 - b. The other of these studies was a 2002 analysis by Ross and Wenzel that suggested that lighter cars have a higher fatality risk because they are the least expensive and, in many cases, the poorest quality cars. The implication of this analysis was that weight reduction is fairly harmless, as long as the lighter cars are of the same "quality" as the heavier cars they replace. NHTSA noted that the Ross and Wenzel analyses did not adjust for driver age and gender. Absent those adjustments, the analysis mingles the effects of what sort of people buy and drive the car with the intrinsic safety of the car, making its conclusions about the intrinsic safety of the car suspect, at best.

As for the DRI reports, NHTSA reviewed its 2002 report and publicly responded in 2004 that the DRI results were strongly biased as a result of including 2-door cars in the analysis. To DRI's credit, they reviewed their report and agreed that this flaw needed to be corrected. DRI submitted a new study which, they say, limited some of their analyses to 4-door cars excluding police cars. DRI further claimed that it could now mimic NHTSA's logistic regression approach for an analysis of model year 1991-98 4-door cars in calendar year 1995-1999 crashes. DRI

²⁹⁰ As discussed below, DRI acknowledged this observation to be accurate and submitted a new 2005 analysis that excludes 2-door cars in response to NHTSA's suggestions.

claims that its new analysis still shows results directionally similar to its earlier work – increased risk for lower track width and wheelbase, reduced risk for lower mass – although DRI acknowledges that the wheelbase and mass effects are no longer statistically significant after removing the 2-door cars from the analysis.

NHTSA does not accept the updated DRI analysis because it contains results that are inconsistent with results NHTSA has seen and, in light of this, DRI has not justified its results. For example, in MY 1991-1998, the average car weighing $x + 100$ pounds had a track width that was 0.34 inches larger and a wheelbase that was 1.01 inch longer. Thus, we could say that a “historical” 100-pound weight reduction would have been accompanied by a 0.34 inch track width reduction and a 1.01 inch wheelbase reduction. However, using a reasonable check, if one dissociates weight, track width, and wheelbase and treats them as independent parameters, DRI’s logistic regression of model year 1991 – 1998 4-door cars excluding police cars attributes the following effects:

DRI – Parameter	Effect on Fatalities
Reduce mass by 100 pounds	379 <u>fewer</u> deaths
Reduce track width by 0.34 inches	1,000 more deaths
Reduce wheelbase by 1.01 inches	207 more deaths
<hr/>	
Reduce mass by 100 lb., track by 0.34, and WB by 1.01 inches	828 more deaths

Now if we apply NHTSA’s logistic regression analyses to NHTSA’s database, exactly as described in the agency’s response to comments on its 2003 report, except for limiting the data to model years 1991-98, instead of 1991-99, the results are not at all like DRI’s. For NHTSA, mass still has the largest effect, exceeding track width, and it moves in the expected direction.

NHTSA – Parameter	Effect on Fatalities
Reduce mass by 100 pounds	485 <u>more</u> deaths
Reduce track width by 0.34 inches	334 more deaths
Reduce wheelbase by 1.01 inches	9 more deaths
<hr/>	
Reduce mass by 100 lb., track by 0.34, and WB by 1.01 inches	828 more deaths

NHTSA obtains its estimates by adding the results from 12 individual logistic regressions: six types of crashes multiplied by two car-weight groups (less than 2,950 pounds; 2,950 pounds or more).²⁹¹ DRI has apparently not followed the same procedures, based on the widely differing results.

Based on the evidence before us now, NHTSA is not persuaded by the DRI analysis. Even though NHTSA’s analyses continue to attribute a much larger effect for mass than for track width or wheelbase in small cars, NHTSA has never said that mass *alone* is the single factor that increases or decreases fatality risk. There may not be a single factor, but rather it may be that mass and some of the other factors that are historically correlated with mass, such as wheelbase

²⁹¹ See, e.g., Kahane (2003), Table 2 on p. xi.

and track width, together are the factors. NHTSA's analyses do not corroborate the 2005 DRI analysis that suggested mass could be reduced without safety harm and perhaps with safety benefit.

We would note that comparatively, it *would seem* the least harmful way to reduce mass would be from materials substitution, where one replaces a heavy material with a lighter one that delivers the same performance, or other designs that reduce mass while maintaining wheelbase and track width. There is an absence of supporting data for the thrust of the 2005 DRI analysis. We cannot analyze data on that yet, because those changes have not happened to any substantial number of vehicles. We do know that mass has historically been correlated with wheelbase and track width, and that reductions in mass have also reduced those other factors. Until there is a more credible analysis than the 2005 DRI study that demonstrates that mass does not matter for safety, NHTSA concludes it should be guided by the decades' worth of studies suggesting that mass is the most important of the related factors.

Analyses for this PRIA

Relevant findings of The Kahane study (NHTSA - 2003)

The Kahane study²⁹² estimates the effect of 100-pound reductions in heavy light trucks and vans (LTVs), light LTVs, heavy passenger cars, and light passenger cars. It compares the fatality rates of LTVs and cars to quantify differences between vehicle types, given drivers of the same age/gender, etc. In this analysis, the effect of "weight reduction" is not limited to the effect of mass *per se* but includes all the factors that were naturally or historically confounded with mass in 1991-1999 cars, such as length, width, structural strength and size of the occupant compartment. The rationale is that adding length, width or strength to a car also makes it heavier. The one exception could be a sweeping replacement of existing materials with light, high-strength components. But when we look at cars of a certain era (namely, 1991-1999), we see they tend to be built in similar ways, and there is essentially a continuum from lighter and smaller cars to heavier, bigger and stronger cars. If future weight reductions were to be achieved entirely by substituting stronger, lighter materials for existing materials – without any accompanying reduction in the size or structural strength of the vehicle – NHTSA believes the fatality increases associated with such weight reductions would likely be smaller than the increases predicted by this model. However, NHTSA does not have information to calibrate and predict how much smaller – because materials substitution has not been applied very extensively in vehicles to date, and consequently there is insufficient crash experience to draw statistically valid conclusions.

Some of the findings of the Kahane study include:

Heavy vehicles had lower fatality rates per billion miles of travel than lighter vehicles of the same general type. When two vehicles collide, the laws of physics favor the occupants on the heavier vehicle (momentum conservation). Furthermore, heavy vehicles were in most cases, longer, wider and less fragile than light vehicles.

²⁹² "Vehicle Weight, Fatality Risk and Crash Compatibility of Model Year 1991-99 Passenger Cars and Light Trucks", Charles J. Kahane, Ph. D., NHTSA, October 2003, DOT HS 809-662. This report is available online at <http://www-nrd.nhtsa.dot.gov/Pubs/809662.PDF>

In part because of this, they usually had greater crashworthiness, structural integrity and directional stability. They were less rollover-prone and easier for the average driver to control in a panic situation. In other words, heavier vehicles tended to be more crashworthy and less crash-prone. Some of the advantages for heavier vehicles are not preordained by the laws of physics, but were nevertheless characteristic of the MY 1991-99 fleet. Offsetting those advantages, heavier vehicles tended to be more aggressive in crashes, increasing risk to occupants of the vehicles they collide with.

Six different crash modes were analyzed (principal rollover, fixed object, pedestrian/bicycle/motorcyclist, and multi-vehicle crashes with heavy truck, light trucks, and passenger cars). Summing all these crash modes together, the net effects per 100-pound weight reduction were:

For passenger cars weighing less than 2,950 pounds – fatalities increased by 4.39 percent

For passenger cars weighing 2,950 pounds or more – fatalities increased by 1.98 percent

For light trucks weighing less than 3,870 pounds – fatalities increased by 2.90 percent

For light trucks weighing 3,870 pounds or more – fatalities increased by 0.48 percent

In all of the above groups, fatalities increased with a reduction in weight, although by much less in the last group. However, further analysis of the Kahane study found that the net safety effect of removing 100 pounds from a light truck is zero in non-rollover crashes for the group of all light trucks with a curb weight greater than 3,900 lbs. Although there is much statistical uncertainty around those figures, we determined that there must be a crossover weight somewhere between 4,264 and 6,121 pounds, with a point estimate at 5,085 pounds, above which there is no safety penalty on individual LTVs for reducing weight.²⁹³ This is because the added harm for other road users from the additional weight exceeds any benefits for the occupants of the vehicles.

The agency believes a number of conclusions can be drawn from these studies:

- Heavier and larger vehicles are more crashworthy and less crash prone.²⁹⁴
- The net impacts on safety, considering the six different crash modes, of reducing weight are negative for all but the larger light trucks. However, this type of analysis cannot examine extreme cases. For example, if there were a large mix shift from 50 percent passenger car and 50 percent light truck sales, to 80 percent compact or smaller passenger cars and 20 percent pickup truck sales, this analysis cannot determine the net impacts on safety. Nothing in the manufacturer's plans suggests a drastic change in the mix of vehicles, nor is there any incentive, in our opinion, for such a change based on NHTSA's attribute based final rule on fuel economy.
- Lighter and smaller vehicles fare worse in single vehicle collisions. In 2006, 57 percent of all passenger car and light truck fatalities were in single vehicle crashes and 43 percent

²⁹³Kahane, Charles J., PhD, Vehicle Weight, Fatality Risk and Crash Compatibility of Model Year 1991-99 Passenger Cars and Light Trucks, October 2003. DOT HS 809 662. Page 161. Docket No. NHTSA-2003-16318 (<http://www-nrd.nhtsa.dot.gov/Pubs/809662.PDF>)

²⁹⁴ See Kahane study, page xiv Table 3 for prorated fatal crash involvements per billion miles.

were in multi-vehicle crashes. Fatalities are almost split between rollovers (29 percent) and collisions with fixed or non-fixed objects (28 percent).

- Reducing weight and size increases the likelihood of rolling over. Increasing track width (part of the footprint calculation) increases a vehicle's stability and reduces its likelihood of rolling over.
- As stated above, in this historical data, where lower weight typically means smaller size, the analyses measure the effect of reducing weight and size at the same time. Analyses that enter mass and size attributes (such as wheelbase or track width) as separate independent variables may not calibrate these effects accurately and are of limited utility in predicting effects of future weight-reduction technologies such as material substitution. With these caveats, NHTSA performed such analyses. They indicated that rollover is the only type of crash in which track width was the dominant factor. In the analyses of cars weighing less than 2,950 pounds, weight was substantially more important than track width or wheelbase in the other five crash modes investigated.²⁹⁵
- Reducing weight increases the likelihood of being killed in a fixed or non-fixed object crash. If a vehicle runs into a tree, the occupant is safer if the vehicle knocks that tree down, rather than if the tree stops the vehicle. A heavier vehicle has a better chance of knocking the tree down.

The Kahane report also examined the total fatality crash rates in all crash modes; including fatalities to occupants of the case vehicle (i.e. in rollovers, single vehicle and multi-vehicle crashes), occupants of the other vehicle it collided with (to account for aggressive vehicles) and pedestrians. Kahane used VMT data based on CDS odometer readings and controlled for age and gender based on State data on nonculpable crash involvements (induced exposure). With these controls, the societal fatality rates per billion miles were:

TABLE IX-1

ADJUSTED FATAL-CRASH INVOLVEMENT RATES
PER BILLION CASE VEHICLE MILES, BY VEHICLE TYPE

(Case vehicles are MY 1996-99 light trucks and 4-door cars with air bags in CY 1996-2000, adjusted for age/gender, rural/urban, day/night, speed limit, and other factors)

Vehicle Type and Size	Average Curb Weight	Fatal Crash Involvements Per Billion Miles
Very small 4-door cars	2,105	15.73
Small 4-door cars	2,469	11.37
Mid-size 4-door cars	3,061	9.46
Large 4-door cars	3,596	7.12
Compact pickup trucks	3,339	11.74

²⁹⁵ See Kahane (Docket No. 2003-16318-16)

Large (100-series) pickup trucks	4,458	9.56
Small 4-door SUVs	3,147	10.47
Mid-size 4-door SUVs	4,022	13.68
Large 4-door SUVs	5,141	10.03
Minivans	3,942	7.97

In other words, mid-size cars had somewhat lower societal fatal crash rates than SUVs that weighed considerably more. Large cars and minivans had the lowest rates.

New Analyses for this PRIA

In evaluating the appropriate levels at which to establish new CAFE standards, NHTSA must assess any potential safety trade-offs. The question of the effect of changes in vehicle weight on safety in the context of fuel economy is a complex question that poses serious analytic challenges and has been a contentious issue for many years. This contentiousness arises, at least in part, from the difficulty of isolating vehicle weight from other confounding factors (*e.g.*, driver factors, such as age and gender, other vehicle factors, such as engine size and wheelbase, and environmental factors, such as rural/urban). In addition, several vehicle factors are closely related, such as vehicle mass, wheelbase, track width, and structural integrity. The issue has been addressed in the literature for more than two decades. For the reader's reference, much more information about safety in the CAFE context is available in the MY 2011 final rule.²⁹⁶

In general, it is unclear if the higher fatality risk of smaller and lighter vehicles is associated more with their reduced mass or their reduced physical dimensions. That is because, historically, the safest vehicles have been heavy and large, while the vehicles with the highest fatal-crash rates have been light and small, both because the crash rate is higher for small/light vehicles and because the fatality rate is higher for small/light vehicle crashes.²⁹⁷ Intuitively, a reduction in mass while maintaining physical dimensions is likely to be less harmful than a reduction in both mass and physical dimensions. Setting CAFE standards based on vehicle footprint size helps to minimize the incentive to reduce a vehicle's physical dimensions, since the corresponding fuel economy target is higher for smaller-footprint vehicles.

However, footprint-based CAFE standards do not discourage manufacturers from reducing vehicle overhang or mass in order to improve fuel economy. Neither the CAFE standards nor our analysis of the feasibility of fuel economy improvements mandates mass reduction or any other specific technology application. In addition, considering NHTSA's analysis of the observed relationship between vehicle mass and the prevalence of fatalities, NHTSA has, except for vehicles with baseline curb weight over 5,000 pounds, excluded weight reduction from its analysis of potential CAFE standards in past rulemakings. The agency followed this analytical approach in order to ensure that its consideration of new standards was not dependent on weight reduction that could compromise highway safety, recognizing, though, that the structure of CAFE standards does not prohibit such responses to new CAFE standards. The agency implemented this approach by setting the Volpe model to apply this exclusion when estimating how manufacturers could apply technology in response to new CAFE standards.

²⁹⁶ 74 FR 14396-14407 (Mar. 30, 2009).

²⁹⁷ Kahane, Charles J., Ph.D., "Vehicle Weight, Fatality Risk and Crash Compatibility of Model Year 1991-99 Passenger Cars and Light Trucks," DOT HS 809 662, October 2003, Executive Summary. Available at <http://www.nhtsa.dot.gov/cars/rules/regrev/evaluate/809662.html> (last accessed August 12, 2009).

In its rulemakings on MY 2008-2011 light truck CAFE standards and MY 2011 car and light truck CAFE standards, NHTSA received comments suggesting that NHTSA expand the applicability of weight reduction technologies in its modeling to vehicles under 5,000 pounds, because weight reduction can be accompanied by proper vehicle design to assure vehicle safety is not compromised. In this rulemaking, NHTSA, in reviewing its assumptions and methodologies per the President's January 26 memorandum and working with EPA, has revised its approach to include weight reduction of up to 5-10 percent of baseline curb weight, depending on vehicle type. Recently-submitted product plans suggest some manufacturers expect that by MY 2016, they will be able to reduce the weight of some specific vehicle models by similar levels. However, NHTSA does not believe that, except where already planned, such significant weight reductions can be achieved in MY 2012 or MY 2013 because there is not enough lead time for the necessary design, engineering, and tooling. NHTSA estimates that weight reductions of 1.5 percent can be achieved during redesigns occurring prior to MY 2014, and that weight reductions of 5-10 percent can be achieved in redesigns occurring in MY 2014 or later. For purposes of analyzing CAFE standards, NHTSA has further assumed that weight reductions would be limited to 5 percent for small vehicles (*e.g.*, subcompact passenger cars), and that reductions of 10 percent would only be applied to the larger vehicle types (*e.g.*, large light trucks).

NHTSA's modeling approach is similar to EPA's in terms of maximum available weight reduction for any vehicle model, sensitive to highway safety in terms of when and to which vehicle types significant weight reduction can be achieved safely, and supported by information in some manufacturers' product plans. Some manufacturers have indicated that, in later model years, they plan to reduce significantly the weight of some specific vehicle models, and that they plan to do so without reducing vehicle size. NHTSA's analysis results in similar degrees of weight reduction, applied more widely to some manufacturers. NHTSA notes, though, that some manufacturers are also planning considerable changes in product mix, and some of these changes could mean reduced average weight along with reduced average size. In NHTSA's (and EPA's) analysis, such changes in product mix are not counted, because they are either in the baseline market forecast, or are not estimated.

As stated above, neither the CAFE standards nor our analysis mandates mass reduction, or mandates that mass reduction occur in any specific manner. However, mass reduction is one of the technology applications available to the manufacturers and a degree of mass reduction is used by the Volpe model to determine the capabilities of manufacturers and to predict both cost and fuel consumption impacts of improved CAFE standards. In this section, we briefly summarize our analysis of the potential impacts of these mass reductions on vehicle safety.

NHTSA's quantified analysis is based on the 2003 Kahane study,²⁹⁸ which estimates the effect of 100-pound reductions in MYs 1991-1999 heavy light trucks and vans (LTVs), light LTVs, heavy passenger cars, and light passenger cars. The study compares the fatality rates of LTVs and cars to quantify differences between vehicle types, given drivers of the same age/gender, etc. In this analysis, the effect of "weight reduction" is not limited to the effect of mass *per se*, but includes all the factors, such as length, width, structural strength, and size of the occupant compartment, that were naturally or historically confounded with mass in MYs 1991-1999 vehicles. The rationale is that adding length, width, or strength to a vehicle will also make it heavier.

²⁹⁸ *Id.*

The agency utilized the relationships between weight and safety from Kahane (2003), expressed as percentage increases in fatalities per 100-pound weight reduction, and examined the weight impacts assumed in this CAFE analysis. However, there are several identifiable safety trends that are already in place or expected to occur in the foreseeable future that are not accounted for in the study. For example, there are two important new safety standards that have already been issued and will be phasing in during the rulemaking time frame. Federal Motor Vehicle Safety Standard No. 126 (49 CFR § 571.126) will require electronic stability control in all new vehicles by MY 2012, and the upgrade to Federal Motor Vehicle Safety Standard No. 214 (Side Impact Protection, 49 CFR § 571.214) will likely result in all new vehicles being equipped with head-curtain air bags by MY 2014.²⁹⁹ Additionally, we anticipate continued improvements in driver (and passenger) behavior, such as higher safety belt use rates. All of these will tend to reduce the absolute number of fatalities. Table IX-4 below shows the overall change in calculated fatalities by calendar year after adjusting for ESC, Side Impact Protection, and other Federal safety standards and behavioral changes projected through this time period. Thus, while the percentage increases in Kahane (2003) was applied, the reduced base has resulted in smaller absolute increases than those that were predicted in the 2003 report.

The agency examined the impacts of identifiable safety trends over the lifetime of the vehicles produced in each model year. An estimate of these impacts was contained in a previous agency report.³⁰⁰ The impacts were estimated on a year-by-year basis, but could be examined in a combined fashion. The agency assumed that the safety trends will result in a reduction in the target population of fatalities from which the weight impacts are derived. Using this method, we found a 12.6 percent reduction in fatality levels between 2007 and 2020. The estimates derived from applying Kahane's percentages to a baseline of 2007 fatalities were thus multiplied by 0.874 to account for changes that the agency believes will take place in passenger car and light truck safety between the 2007 baseline on-road fleet used for this particular analysis and year 2020.

We note that because these new analyses are based on the method shown in Kahane (2003), which predicts the safety effect of 100-pound mass reductions in MY 1991-1999 light trucks and vans (LTVs) and passenger cars, the new analyses need to be understood in the context of that study. Specifically, the numbers in the new analyses represent a worst case estimate—that is, the estimate would only apply if all weight reductions come from reducing both weight and footprint in the same proportion that such designs impacted the original study. Kahane's conclusions are based upon a cross-sectional analysis of the actual on-road safety experience of MY 1991-1999 vehicles. For those vehicles, heavier usually also meant larger-footprint. Hence, the numbers in the new analyses predict the safety consequences that would occur in the unlikely event that weight reduction for MY 2012-2016 vehicles is accomplished mostly by making the vehicles smaller—that is, again, reducing mass *and* reducing footprint.

²⁹⁹ We note that the Volpe model currently does not account for the weight of safety standards that will be added compared to the MY 2008 baseline, nor does it account for the societal cost of reductions in weight. However, both of these items will be added to the model for the final rule; doing so will raise the weight of every vehicle by roughly 17 pounds in MY 2016 (slightly less in earlier years), which will likely require manufacturers to add slightly more technology to reach the final standards than they were estimated to need to reach the proposed standards. However, NHTSA does not expect the impact of these roughly 17 pounds per vehicle to have a significant impact on the safety analysis.

³⁰⁰ Blincoe, L. and Shankar, U, "The Impact of Safety Standards and Behavioral Trends on Motor Vehicle Fatality Rates," DOT HS 810 777, January 2007. See Table 4 comparing 2020 to 2007 ($37,906/43,363 = 12.6\%$ reduction ($1 - .126 = .874$))

Exclusive reliance on making vehicles smaller and lighter in response to this rulemaking is unlikely for the following reasons. The flat CAFE standards in effect when those MY1991-1999 vehicles were produced had no penalty for such a strategy for improving fuel economy. In contrast, as discussed above, the current attribute-based CAFE standards do not encourage making vehicles smaller by reducing footprint. This structural change to the CAFE program means that the CAFE standards now favor the use of weight reduction strategies, like material substitution, downsizing the engine and adding turbocharging, that do not involve simply making the vehicle footprint smaller.

Given this structural change to the CAFE program, it is likely that a significant portion of the weight reduction in the MY 2012-2016 vehicles will be accomplished by strategies that have a lesser safety impact than the prevalent 1990s strategy of simply making the vehicles smaller, although NHTSA is unable to predict how large a portion. For example, a manufacturer could conceivably add length, width, or strength to a vehicle by replacing existing materials with light, high-strength components.

To the extent that future weight reductions could be achieved by substituting light, high-strength materials for existing materials or by engine downsizing—without any accompanying reduction in the footprint size or structural strength of the vehicle—then NHTSA believes that the fatality increases associated with the weight reductions anticipated by the model as a result of the proposed standards could be significantly smaller than those in the worst-case scenario. However, NHTSA does not currently have information (on-road data) to calibrate and predict how much smaller those increases would be for any given mixture of material substitution and other methods of reducing mass, since the data on the safety effects of material substitution alone is not available due to the low numbers of vehicles in the current on-road fleet that have utilized this technology extensively. Further, to the extent that weight reductions were accomplished through use of light, high-strength materials, there would be significant additional costs that would need to be determined and accounted for.

Nevertheless, even though NHTSA cannot quantify these safety effects, we can project that they could be significantly less than those that would result from making smaller and lighter vehicles. We are also convinced that the safety effects are larger than zero for the following reasons:

- The following effects of mass *per se* (laws of physics) will persist whether mass is reduced by material substitution, making vehicles smaller, or any other method:
 - The increased weight disadvantage in collisions with vehicles not covered by the regulation, such as medium-sized trucks (GVWR somewhat larger than 10,000 pounds).
 - In collisions with partially movable objects such as not-so-large trees.
- Our attribute-based standards have the excellent feature that they do not encourage reductions in footprint. However, weight can be removed by means other than material substitution or engine downsizing, in a manner that further increases risk to occupants, even while maintaining footprint:
 - By reducing the overhang in front of the front wheels and behind the rear wheels. These are protective structures whose removal would increase risk to occupants by reducing vehicle crush space.

- By thinning or removing structures within the vehicle.

Table IX-2 shows the results of NHTSA's safety analysis separately for each model year. Additionally, the societal impacts of increasing fatalities can be monetized using NHTSA's estimated comprehensive cost per life of \$6.1 million. This consists of a value of a statistical life of \$5.8 million plus external economic costs associated with fatalities such as medical care, insurance administration costs and legal costs.³⁰¹ Typically, NHTSA would also estimate the impact on injuries and add that to the societal costs of fatalities, but in this case NHTSA does not have a model estimating the impact of weight on injuries. However, based on past studies, fatalities account for roughly 44 percent of total comprehensive costs due to injury.³⁰² If weight impacts non-fatal injuries roughly proportional to its impact on fatalities, then total costs would be roughly 2.3 times those noted in Table IX-3. The potential societal costs for just fatalities are shown in Table IX-3.

Looking at the results on a calendar year basis, we also note that the safety impacts of the Kahane analysis based weight reduction have a slow onset. Passenger cars typically have a 10-25 year lifetime, and light trucks somewhat longer. Thus, some of the fatalities for MY 2016 light trucks will not occur until after 2050. Moreover, the weight reductions are small in the early model years 2012 and 2013. The vehicles with reduced weight will only be a small proportion of the entire on-road fleet in the initial calendar years of these proposed CAFE standards. The influence of these factors is illustrated in Table IX-4.

The slow onset of the safety impact of weight reduction will provide time to monitor the situation, to quantify those impacts more precisely, and to make changes as necessary in future rulemakings. If lighter vehicles are introduced into the fleet, NHTSA would continue to monitor how any weight reductions are accomplished. After there is a sufficient number of vehicles that have used specific weight reduction techniques, NHTSA could update the 2003 Kahane study. NHTSA would also conduct tests of the performance of the new vehicles compared to the older designs of the vehicles. If the safety effects of any weight reduction are substantial, NHTSA would take corrective actions. However, the slow onset and the time necessary to gain sufficient on-road experience to generate the data needed for the updated study are important considerations, because they mean that NHTSA cannot act before the MY 2012-2016 vehicles have been produced.

Additionally, there will be significant fuel-saving benefits from these proposed standards, up to 61.6 billion gallons during the lifetime of MYs 2012-2016 vehicles, as well as significant reductions in CO₂ emissions, up to 656 million metric tons during that same time period. Improved fuel economy will also result in a decrease in harmful criteria pollutants, which will decrease premature deaths due to a number of diseases related to environmental pollution. The literature strongly supports the causal relationship between health and exposure to criteria pollutants. However, as with vehicle safety impacts, there is much uncertainty regarding the exact level of health impacts that might be achieved with this rule. A detailed discussion of these impacts is included in NHTSA's DEIS, which documents a selection of health outcomes from

³⁰¹ Blincoe et al, *The Economic Impact of Motor Vehicle Crashes 2000*, May 2002, DOT HS 809 446. Data from this report were updated for inflation and combined with the current DOT guidance on value of a statistical life to estimate the comprehensive value of a statistical life.

³⁰² Based on data in Blincoe et al updated for inflation and reflecting the Department's current VSL of \$5.8 million.

improved air quality.³⁰³ NHTSA approximated some PM_{2.5}-related health benefits using screening-level estimates in the form of cases per ton of criteria emissions reduced.³⁰⁴ Due to analytical limitations, the estimated values do not include comparable benefits related to reductions in other criteria pollutants (such as ozone, NO₂ or SO₂) or toxic air pollutants, nor do they monetize all of the potential health and welfare effects associated with PM_{2.5} or the other criteria pollutants.

As illustrative examples, the number of PM_{2.5}-related premature deaths prevented in calendar year 2016 is estimated to range from 39-99 due to reduced PM_{2.5} as a result of the MY 2012-2016 standards while in 2030, we estimate between 217-544 premature deaths prevented. However, by 2030, most, but not all of the on-road fleet will already meet the CAFE requirements established for MY 2016, so some further growth in these impacts is possible. Other PM_{2.5}-related health impacts estimated to occur during this period include 26 in 2016 and 142 by 2030 fewer cases of chronic bronchitis and 37 in 2016 and 198 for 2030 fewer emergency room visits for asthma. These benefits will partially offset any negative safety impacts that may occur from vehicle mass reduction associated with higher CAFE standards. Thus, there are potentially both positive and negative impacts that could result from this rulemaking, and the overall impact on health and safety is uncertain. We have not attempted to quantify other beneficial health impacts that are expected to result from the proposed standards, including the results of a decrease in the rate of global warming, and increased energy security resulting from a lesser dependence on oil imported volatile regions of the world, but they, too, could be significant.

In summary, the agency recognizes the balancing inherent in achieving higher levels of fuel economy through reduction of vehicle weight. We emphasize that these safety-related fatality estimates represent a worst case scenario for the potential effects of this rulemaking, and that actual fatalities will be less than these estimates, possibly significantly less, based on the qualitative discussion above of the various factors that could reduce the estimates. At the same time, however, the agency cannot specify a lower-bound estimate. It is possible that the impact could be very small but the agency is not able to specify a lower-bound at this time based on lack of studies that address the safety risk associated with weight reduction that is not also accompanied by size reduction, as well as to isolate the risks that remain from simple mass reduction. Additionally, the estimates presented here do not include estimates for injuries.

The tables below contain NHTSA's estimates of the safety-related fatality impacts of the proposed standards, the costs associated with those impacts, and the overall change in impacts given other anticipated mitigating effects during the next several years. Again, we emphasize that the safety-related fatality impacts presented below represent a worst case scenario.

³⁰³ Chapter 7 of EPA's DRIA also contains information on the health impacts of reducing criteria pollutants.

³⁰⁴ Ideally, the human health benefits would be estimated based on changes in ambient PM_{2.5} concentrations and population exposure, as determined by full-scale air quality and exposure modeling. Such detailed modeling was not possible within the timeframe for this proposal, but for the final rule, a national-scale air quality modeling analysis will be performed to analyze the impacts of the standards on PM_{2.5}, ozone, and selected air toxics.

NHTSA seeks comments on its analysis of the safety impacts of the proposed standards. To aid the agency in refining its analysis for the final rule, including its attempts to assess reasonable upper and lower ends of the potential range of estimated fatalities, NHTSA requests that each vehicle manufacturer provide, for inclusion in the record of this rulemaking, detailed information concerning the extent to which and manner in which it plans to reduce the weight of each of its models for the period covered by this rulemaking, and the cost of each method used. Manufacturers should include in those plans whether there will be any footprint, overhang or other size reductions, whether through reducing the size of an existing model, mix shifting or other means. Please also submit the analysis, including engineering or computer simulation analysis, performed to assess the possible safety impacts of such planned weight reduction. In addition, please submit the results of any vehicle crash or component tests that would aid in assessing those impacts.

Table IX-2
Comparison of the Calculated Worst Case Weight Safety-Related Fatality Impacts of the
Pending Proposed Standards over the Lifetime of the Vehicles Produced in each Model
Year
(Increase in Fatalities compared to the Calendar Year 2007 Fatality Level)

	Baseline MY 2011 standards continued for lifetime of vehicles				
	MY 2012	MY 2013	MY 2014	MY 2015	MY 2016
Passenger cars	13	15	18	18	19
Light trucks	13	15	17	17	18
Combined	26	30	35	35	37
	Proposed standards				
	MY 2012	MY 2013	MY 2014	MY 2015	MY 2016
Passenger cars	42	64	165	242	379
Light trucks	18	20	64	106	150
Combined	60	84	229	348	530
	Difference between proposed standards and baseline continued				
	MY 2012	MY 2013	MY 2014	MY 2015	MY 2016
Passenger cars	29	49	147	224	360
Light trucks	5	5	47	89	132
Combined	34	54	194	313	493

Note – all estimates in this table are worst-case. Actual values could be significantly less.

Table IX-3
Calculated Worst Case Weight Safety Impacts on Societal Costs for the Proposed
Standards over the Lifetime of the Vehicles Produced in each Model Year
Estimated Fatalities and Assumed Injuries
(\$ millions)

Undiscounted	MY 2012	MY 2013	MY 2014	MY 2015	MY 2016	Total
Passenger Cars	\$406	\$686	\$2,058	\$3,136	\$5,040	\$11,326
Light Trucks	70	70	658	1,246	1,848	3,892
Combined	476	756	2,716	4,382	6,888	15,218
Discounted 3%						
Passenger Cars	337	570	1,709	2,604	4,185	9,405
Light Trucks	56	56	528	1,000	1,482	3,122
Combined	393	626	2,237	3,604	5,668	12,527
Discounted 7%						
Passenger Cars	272	460	1,379	2,101	3,377	7,588
Light Trucks	44	44	415	785	1,165	2,453

Combined 316 504 1,794 2,886 4,542 10,042
Note – all estimates in this table are worst-case. Actual values could be significantly less.

Discount factors

	3%	7%
Pass.		
Car	0.8304	0.67
LT	0.8022	0.6303

Table IX-4
Estimated Worst Case Impact of Weight on Calculated Fatalities by Calendar Year
(Additional fatalities by model year and calendar year)

	MY 2012	MY 2013	MY 2014	MY 2015	MY 2016	MY 2017	MY 2018	MY 2019	MY 2020	Totals
2012	3									3
2013	3	5								8
2014	3	5	19							27
2015	3	5	19	30						57
2016	3	5	18	29	47					102
2017	3	5	17	28	46	47				146
2018	3	5	16	27	44	46	47			187
2019	3	4	16	26	42	44	46	47		226
2020	2	4	15	24	40	42	44	46	47	264

Note – all estimates in this table are worst-case. Actual values could be significantly less.

Appendix A – A discussion of the safety aspects of methods of reducing weight reduction and specific crash types

There are a wide variety of methods of reducing vehicle weight. For this discussion, we are assuming that weight reduction would be accomplished without changing the vehicle footprint, because attribute-based CAFÉ removes the incentive to reduce footprint. However, some methods of reducing weight, even while maintaining footprint, would have more serious impacts on safety than others. First, methods that reduce crush space (e.g., a reduction in the vehicle front³⁰⁵, side, or rear overhang – which could be accomplished while keeping footprint the same) would result in higher accelerations being experienced by the occupants or in higher levels of intrusion. Either situation would be extremely detrimental to safety. Second, methods that use thinner structure or less structure that reduce structural strength could result in more intrusion and are likewise extremely detrimental to safety. Third, methods that reduce track width (but maintain footprint by extending wheelbase) would increase the threat of rollover and would also be extremely detrimental to safety.

In general, the discussions below examine two methods of reducing weight that from a safety perspective might be considered a “best-case scenario” of either engine size reductions or material substitution. In NHTSA’s opinion, these methods would have a smaller safety impact than any of the three methods mentioned above. However, the safety impact is not zero, as shown below. There are a variety of crash types that could be impacted in various ways by changes in vehicle weight and at times by the way in which the vehicle’s weight is changed. The following discussion examines weight reduction by either engine size reductions or material substitution and its impact on each of the different crash types.

Let us assume that Car A weighs X pounds and that Car B weighs X-100 pounds and that Cars A and B have the same footprint, overhang and structural strength.

Single-vehicle crashes

Hitting an immovable object (like a big tree or bridge abutment)

In most cases, there would be little impact on vehicle safety if Car A and Car B each hit a different immovable object at the same speed because delta V would be the same for both vehicles. Delta-V is a measure of the change in velocity experienced by the vehicle occupants when they impact the vehicle interior or other structures, and is the primary measure for crash severity. When a vehicle crashes into an immovable object and is brought to a stop, the delta V is roughly equal to the travel speed of the vehicle. Assuming that Cars A and B have the same frontal structure, Car A would experience slightly more crush. That is a potential advantage in the absence of severe intrusion (more ride-down), but it could be a disadvantage if the crash is severe enough and it adds to critical levels of intrusion. Overall, we believe there will be no difference between Car A and Car B safety.

³⁰⁵ Another safety problem with reducing front overhang relates to pedestrian safety. If the front hood surface (as might occur with right sizing) was shortened, that would increase the risk of the pedestrian hitting the dangerous perimeter of the windshield, rather than merely hitting the relatively soft hood.

Hitting a partially movable object (like a small tree, parked car, storefront, or dwelling)

Heavier vehicles will impart more force to movable objects than lighter vehicles. This will increase the chance that the movable objects will break, crush, or otherwise give way and increase the distance over which the striking vehicle can decelerate, which will reduce the delta-V for the vehicle's occupants. If Car A can knock down a small tree, but Car B is stopped by the same small tree, delta V is higher for the stopped Car B, and Car B would be less safe.

Single-vehicle rollovers

Smaller vehicles end up in more rollover crashes than larger vehicles. Part of the reason for this is the static stability factor, since smaller vehicles have less track width. Part of the reason for this is the way smaller vehicles are driven. Given the same track width for Car A and Car B, the impact on rollovers is hard to determine since the weight helps build up momentum and the influence of momentum versus weight for tripped rollovers is hard to discern.

Multi-vehicle crashes

Frontal impact – two light vehicles

While a collision of Car B with Car B is likely to have the same risk as a similar collision of Car A with Car A, the final answer on safety will depend upon what vehicle sizes receive overall weight reductions. As NHTSA's study shows, if weight is taken out of the larger light trucks, overall safety is improved. If weight is taken out of passenger cars or smaller light trucks, overall safety decreases. Overall, we can't determine whether there will be an overall difference in safety.

Side impact – struck vehicle

The struck vehicle in a side impact that weighs less is at a disadvantage because its delta V would be increased. Car B would be less safe.

Side impact – striking vehicle

NHTSA analyses have shown that for a striking vehicle in a side impact, weight is not as important as striking height. Weight does have an impact, because of imparting a lower delta V on the struck vehicle. Car B would be somewhat safer.

Side impact – overall

Overall, there will be a minimal difference in safety.

Collision with an older light vehicle

Car B would experience a higher delta V and a higher fatality risk than Car A, if either were struck by the same pre-2012 vehicle. But the occupants of the older vehicle would experience a lower delta V and a lower risk if struck by Car B. To the extent that the average pre-2012 vehicle is heavier than the CAFE-regulated fleet, the increase in risk for the occupants of Car B will usually be greater than the reduction for the occupants of the older vehicle. So, Car B would be less safe.

Collision with a medium-sized truck (somewhat over 10,000 GVWR)

Medium-size trucks are not affected by CAFÉ and don't need to decrease their weight. Car B would experience a higher delta V and a higher risk than Car A. (The risk to the occupants of the medium-size truck would be minimally higher with Car A.) Overall, Car B would be less safe.

Collision with a fully-loaded tractor trailer (far above 10,000 GVWR)

Car B would experience a higher delta V than Car A, but in this case, the difference in delta V would be minimal. Risk would be similar in both cars.

Pedestrian/bicyclist impacts

In general, Car A would impose a slightly higher delta V on the pedestrian than Car B, but the difference would be so small that risk for the pedestrian would essentially be the same either way. This assumes, as stated above, that Cars A and B have exactly the same exterior dimensions and differ only in weight. Pedestrian safety is strongly related to the vehicle front end shape. A vehicle hood is softer than the windshield frame, making cars with longer front ends relatively less injurious to the heads of pedestrians.

In summary, nine separate crash modes were examined for the impact of reducing weight (by reducing engine size or material substitution) on safety, assuming Car B weighs 100 pounds less than Car A. In four modes, Car B will be less safe (striking a partially movable object, rollovers, older vehicles, medium trucks). In five modes, we believe there would be no real difference in safety or the difference is not discernable until we see the distribution of weight reductions among the fleet (striking immovable object, frontal impacts, side impacts, heavy trucks, and pedestrian/pedalcyclists).

X. NET BENEFITS AND SENSITIVITY ANALYSES

This chapter compares the costs of technologies needed to make improvements in fuel economy with the potential benefits, expressed in total costs (millions of dollars) from a societal perspective for each model year. The costs do not include fines, since these are transfer payments. Thus, the total costs shown in this section do not match the total costs shown in Chapter VII. These are incremental costs and benefits compared to the adjusted baseline of manufacturers' plans. A payback period is calculated, from the consumer's perspective. Finally, sensitivity analyses are also performed on some of the assumptions made in this analysis.

Table X-1 provides the total incremental costs (in millions of dollars) from a societal perspective. Table X-2 provides the total benefits at a 3 percent discount rate from a societal perspective for all vehicles produced. Table X-3 shows the total net benefits at a 3 percent discount rate in millions of dollars for the projected fleet of sales for MY 2012 – MY 2016. Table X-4 provides the total benefits at a 7 percent discount rate from a societal perspective for all vehicles produced. Table X-5 shows the total net benefits at a 7 percent discount rate in millions of dollars for the projected fleet of sales for MY 2012 – MY 2016.

Total costs follow a predictable pattern with costs rising to reflect the more expensive technologies that manufacturers must apply in order to achieve the CAFE levels that are required under the more aggressive alternatives. Total compliance costs for the passenger cars under the Total Cost = Total Benefit alternative are roughly 3 times those under the Preferred Alternative. For light trucks, compliance costs are 6 times higher under the Total Cost = Total Benefit alternative than under the Preferred Alternative.

In Tables X-2 and X-4, lifetime societal benefits follow a similar predictable pattern, with higher benefits associated with the more expensive technologies that are enabled under the more aggressive alternatives. For the combined fleet, the TC=TB alternative produces gross benefits roughly twice as high as the Preferred Alternative, for both passenger cars and light trucks.

Tables X-3 and X-5 present the net benefits to society produced by each alternative. Each alternative, including the Preferred Alternative, results in a net benefit to society. In Table X-3, the combined net benefit for passenger cars and light trucks under all five model years ranges from \$92 billion under the 3% Annual Increase alternative to \$189 billion under the Total Cost = Total Benefit alternative. Net benefits for the Preferred Alternative (the total under both vehicle types and all model years) are \$142 billion.

Table X-1
Incremental Total Cost – Societal Perspective
(Millions of 2007 Dollars)

Alternative	MY 2012	MY 2013	MY 2014	MY 2015	MY 2016	5-Year Total
Passenger Cars						
Preferred Alternative	\$4,148	\$6,535	\$8,409	\$9,908	\$11,781	\$40,781
3% Annual Increase	\$1,179	\$2,885	\$4,076	\$5,149	\$6,332	\$19,621
4% Annual Increase	\$1,807	\$4,052	\$5,974	\$7,611	\$9,200	\$28,643
5% Annual Increase	\$2,832	\$6,453	\$9,383	\$11,470	\$13,981	\$44,118
6% Annual Increase	\$4,286	\$9,138	\$13,333	\$16,121	\$19,094	\$61,972
7% Annual Increase	\$4,820	\$9,448	\$14,195	\$17,601	\$21,451	\$67,514
Max Net Benefits	\$5,281	\$9,517	\$13,881	\$16,859	\$18,948	\$64,486
Total Cost = Total Benefit	\$6,202	\$10,918	\$16,183	\$19,269	\$21,952	\$74,524
Light Trucks						
Preferred Alternative	\$1,547	\$2,760	\$4,045	\$5,172	\$5,852	\$19,376
3% Annual Increase	\$630	\$1,158	\$1,898	\$2,743	\$3,189	\$9,617
4% Annual Increase	\$1,308	\$2,453	\$3,798	\$4,875	\$5,396	\$17,830
5% Annual Increase	\$2,063	\$4,224	\$6,783	\$8,223	\$9,081	\$30,375
6% Annual Increase	\$2,494	\$5,677	\$9,077	\$11,576	\$12,304	\$41,128
7% Annual Increase	\$3,017	\$7,034	\$10,721	\$13,382	\$14,704	\$48,856
Max Net Benefits	\$4,113	\$7,853	\$10,659	\$12,581	\$12,857	\$48,063
Total Cost = Total Benefit	\$4,177	\$8,327	\$11,790	\$13,943	\$14,515	\$52,752
Passenger Cars & Light Trucks, Combined						
Preferred Alternative	\$5,695	\$9,294	\$12,454	\$15,081	\$17,633	\$60,156
3% Annual Increase	\$1,809	\$4,043	\$5,974	\$7,892	\$9,521	\$29,238
4% Annual Increase	\$3,115	\$6,505	\$9,772	\$12,487	\$14,596	\$46,474
5% Annual Increase	\$4,895	\$10,677	\$16,165	\$19,693	\$23,062	\$74,493
6% Annual Increase	\$6,780	\$14,816	\$22,410	\$27,697	\$31,398	\$103,100
7% Annual Increase	\$7,837	\$16,482	\$24,916	\$30,982	\$36,154	\$116,371
Max Net Benefits	\$9,394	\$17,370	\$24,541	\$29,440	\$31,805	\$112,550
Total Cost = Total Benefit	\$10,379	\$19,245	\$27,973	\$33,212	\$36,467	\$127,276

Table X-2
 Present Value of Lifetime Societal Benefits by Alternative
 3 % Discount Rate
 (Millions of 2007 Dollars)

Alternative	MY 2012	MY 2013	MY 2014	MY 2015	MY 2016	5-Year Total
Passenger Cars						
Preferred Alternative	\$7,644	\$17,047	\$24,450	\$31,224	\$38,730	\$119,096
3% Annual Increase	\$3,367	\$10,578	\$15,652	\$20,197	\$25,962	\$75,757
4% Annual Increase	\$5,141	\$13,815	\$21,529	\$28,652	\$35,639	\$104,777
5% Annual Increase	\$6,915	\$18,010	\$27,995	\$35,592	\$45,265	\$133,777
6% Annual Increase	\$8,277	\$21,197	\$33,429	\$42,482	\$52,972	\$158,358
7% Annual Increase	\$8,916	\$22,921	\$36,032	\$46,015	\$57,389	\$171,274
Max Net Benefits	\$9,795	\$23,863	\$36,113	\$44,842	\$51,805	\$166,419
Total Cost = Total Benefit	\$10,699	\$25,435	\$38,643	\$47,841	\$56,235	\$178,853
Light Trucks						
Preferred Alternative	\$5,488	\$11,633	\$17,331	\$22,170	\$25,957	\$82,580
3% Annual Increase	\$1,969	\$5,129	\$9,274	\$13,511	\$16,418	\$46,301
4% Annual Increase	\$3,311	\$8,831	\$15,127	\$20,341	\$23,818	\$71,429
5% Annual Increase	\$4,228	\$11,526	\$20,010	\$26,902	\$31,342	\$94,009
6% Annual Increase	\$4,906	\$14,146	\$24,100	\$32,895	\$37,996	\$114,044
7% Annual Increase	\$6,129	\$16,401	\$27,520	\$36,714	\$41,708	\$128,471
Max Net Benefits	\$8,533	\$19,661	\$28,851	\$35,538	\$37,908	\$130,491
Total Cost = Total Benefit	\$8,738	\$20,213	\$30,142	\$37,736	\$40,924	\$137,752
Passenger Cars & Light Trucks, Combined						
Preferred Alternative	\$13,132	\$28,680	\$41,781	\$53,395	\$64,688	\$201,676
3% Annual Increase	\$5,336	\$15,708	\$24,925	\$33,709	\$42,380	\$122,058
4% Annual Increase	\$8,452	\$22,647	\$36,657	\$48,993	\$59,457	\$176,205
5% Annual Increase	\$11,143	\$29,536	\$48,006	\$62,494	\$76,608	\$227,786
6% Annual Increase	\$13,183	\$35,343	\$57,529	\$75,378	\$90,969	\$272,401
7% Annual Increase	\$15,045	\$39,322	\$63,552	\$82,729	\$99,097	\$299,746
Max Net Benefits	\$18,328	\$43,524	\$64,964	\$80,380	\$89,713	\$296,910
Total Cost = Total Benefit	\$19,437	\$45,647	\$68,785	\$85,577	\$97,159	\$316,605

Table X-3
 Net Total Benefits
 Over the Vehicle's Lifetime – Present Value
 3% Discount Rate
 (Millions of 2007 Dollars)

Alternative	MY 2012	MY 2013	MY 2014	MY 2015	MY 2016	5-Year Total
Passenger Cars						
Preferred Alternative	\$3,496	\$10,513	\$16,041	\$21,316	\$26,949	\$78,315
3% Annual Increase	\$2,188	\$7,693	\$11,576	\$15,048	\$19,630	\$56,135
4% Annual Increase	\$3,334	\$9,763	\$15,555	\$21,041	\$26,439	\$76,133
5% Annual Increase	\$4,083	\$11,558	\$18,612	\$24,122	\$31,284	\$89,660
6% Annual Increase	\$3,991	\$12,059	\$20,096	\$26,361	\$33,878	\$96,385
7% Annual Increase	\$4,096	\$13,473	\$21,837	\$28,414	\$35,938	\$103,760
Max Net Benefits	\$4,514	\$14,346	\$22,232	\$27,983	\$32,857	\$101,932
Total Cost = Total Benefit	\$4,497	\$14,516	\$22,460	\$28,572	\$34,283	\$104,328
Light Trucks						
Preferred Alternative	\$3,941	\$8,874	\$13,286	\$16,998	\$20,106	\$63,204
3% Annual Increase	\$1,339	\$3,972	\$7,376	\$10,769	\$13,229	\$36,685
4% Annual Increase	\$2,003	\$6,378	\$11,330	\$15,465	\$18,422	\$53,598
5% Annual Increase	\$2,165	\$7,302	\$13,228	\$18,679	\$22,261	\$63,634
6% Annual Increase	\$2,412	\$8,469	\$15,023	\$21,319	\$25,693	\$72,916
7% Annual Increase	\$3,112	\$9,367	\$16,799	\$23,333	\$27,004	\$79,615
Max Net Benefits	\$4,420	\$11,808	\$18,192	\$22,957	\$25,051	\$82,428
Total Cost = Total Benefit	\$4,561	\$11,886	\$18,352	\$23,793	\$26,408	\$85,000
Passenger Cars & Light Trucks, Combined						
Preferred Alternative	\$7,438	\$19,386	\$29,327	\$38,314	\$47,055	\$141,519
3% Annual Increase	\$3,527	\$11,665	\$18,952	\$25,817	\$32,859	\$92,820
4% Annual Increase	\$5,337	\$16,142	\$26,885	\$36,507	\$44,861	\$129,731
5% Annual Increase	\$6,248	\$18,859	\$31,840	\$42,800	\$53,546	\$153,294
6% Annual Increase	\$6,403	\$20,528	\$35,119	\$47,681	\$59,571	\$169,301
7% Annual Increase	\$7,208	\$22,841	\$38,637	\$51,747	\$62,942	\$183,375
Max Net Benefits	\$8,934	\$26,154	\$40,424	\$50,940	\$57,908	\$184,360
Total Cost = Total Benefit	\$9,058	\$26,402	\$40,812	\$52,365	\$60,692	\$189,329

Table X-4
 Present Value of Lifetime Societal Benefits by Alternative
 7 % Discount Rate
 (Millions of 2007 Dollars)

Alternative	MY 2012	MY 2013	MY 2014	MY 2015	MY 2016	5-Year Total
Passenger Cars						
Preferred Alternative	\$6,037	\$13,574	\$19,533	\$25,021	\$31,107	\$95,273
3% Annual Increase	\$2,655	\$8,433	\$12,510	\$16,195	\$20,868	\$60,660
4% Annual Increase	\$4,066	\$11,021	\$17,222	\$22,985	\$28,647	\$83,941
5% Annual Increase	\$5,455	\$14,344	\$22,364	\$28,521	\$36,356	\$107,039
6% Annual Increase	\$6,541	\$16,892	\$26,708	\$34,041	\$42,544	\$126,726
7% Annual Increase	\$7,048	\$18,271	\$28,797	\$36,871	\$46,095	\$137,083
Max Net Benefits	\$6,769	\$17,911	\$27,635	\$34,638	\$41,105	\$128,058
Total Cost = Total Benefit	\$7,670	\$19,304	\$29,703	\$37,371	\$45,830	\$139,878
Light Trucks						
Preferred Alternative	\$4,255	\$9,057	\$13,533	\$17,359	\$20,361	\$64,564
3% Annual Increase	\$1,527	\$3,996	\$7,243	\$10,581	\$12,880	\$36,227
4% Annual Increase	\$2,568	\$6,879	\$11,813	\$15,926	\$18,682	\$55,868
5% Annual Increase	\$3,273	\$8,957	\$15,603	\$21,040	\$24,565	\$73,437
6% Annual Increase	\$3,798	\$10,996	\$18,784	\$25,688	\$29,737	\$89,003
7% Annual Increase	\$4,745	\$12,748	\$21,450	\$28,669	\$32,639	\$100,251
Max Net Benefits	\$6,611	\$15,227	\$22,245	\$27,534	\$29,885	\$101,501
Total Cost = Total Benefit	\$6,769	\$15,710	\$23,492	\$29,462	\$32,020	\$107,453
Passenger Cars & Light Trucks						
Preferred Alternative	\$10,293	\$22,631	\$33,066	\$42,379	\$51,468	\$159,837
3% Annual Increase	\$4,182	\$12,429	\$19,753	\$26,775	\$33,748	\$96,888
4% Annual Increase	\$6,634	\$17,899	\$29,035	\$38,911	\$47,329	\$139,809
5% Annual Increase	\$8,727	\$23,300	\$37,968	\$49,561	\$60,921	\$180,476
6% Annual Increase	\$10,338	\$27,888	\$45,493	\$59,729	\$72,281	\$215,729
7% Annual Increase	\$11,793	\$31,019	\$50,247	\$65,541	\$78,735	\$237,335
Max Net Benefits	\$13,380	\$33,138	\$49,880	\$62,172	\$70,990	\$229,560
Total Cost = Total Benefit	\$14,439	\$35,014	\$53,194	\$66,833	\$77,850	\$247,331

Table X-5
 Net Total Benefits
 Over the Vehicle's Lifetime – Present Value
 7% Discount Rate
 (Millions of 2007 Dollars)

Alternative	MY 2012	MY 2013	MY 2014	MY 2015	MY 2016	5-Year Total
Passenger Cars						
Preferred Alternative	\$1,890	\$7,040	\$11,124	\$15,112	\$19,326	\$54,492
3% Annual Increase	\$1,476	\$5,548	\$8,434	\$11,046	\$14,536	\$41,039
4% Annual Increase	\$2,259	\$6,969	\$11,248	\$15,374	\$19,447	\$55,297
5% Annual Increase	\$2,623	\$7,891	\$12,982	\$17,051	\$22,375	\$62,921
6% Annual Increase	\$2,255	\$7,753	\$13,375	\$17,920	\$23,450	\$64,754
7% Annual Increase	\$2,228	\$8,823	\$14,602	\$19,271	\$24,645	\$69,569
Max Net Benefits	\$2,178	\$8,849	\$14,368	\$18,762	\$22,944	\$67,101
Total Cost = Total Benefit	\$2,340	\$9,439	\$14,998	\$19,451	\$24,406	\$70,635
Light Trucks						
Preferred Alternative	\$2,708	\$6,297	\$9,488	\$12,186	\$14,509	\$45,189
3% Annual Increase	\$898	\$2,838	\$5,345	\$7,838	\$9,692	\$26,611
4% Annual Increase	\$1,260	\$4,426	\$8,015	\$11,051	\$13,287	\$38,038
5% Annual Increase	\$1,209	\$4,732	\$8,821	\$12,817	\$15,484	\$43,062
6% Annual Increase	\$1,304	\$5,319	\$9,708	\$14,112	\$17,433	\$47,875
7% Annual Increase	\$1,728	\$5,714	\$10,729	\$15,288	\$17,936	\$51,395
Max Net Benefits	\$2,497	\$7,388	\$11,675	\$14,867	\$16,933	\$53,361
Total Cost = Total Benefit	\$2,592	\$7,383	\$11,702	\$15,519	\$17,505	\$54,701
Passenger Cars & Light Trucks						
Preferred Alternative	\$4,598	\$13,337	\$20,612	\$27,299	\$33,835	\$99,681
3% Annual Increase	\$2,373	\$8,386	\$13,780	\$18,883	\$24,227	\$67,650
4% Annual Increase	\$3,520	\$11,394	\$19,263	\$26,425	\$32,734	\$93,335
5% Annual Increase	\$3,832	\$12,623	\$21,802	\$29,867	\$37,859	\$105,983
6% Annual Increase	\$3,558	\$13,072	\$23,083	\$32,032	\$40,883	\$112,629
7% Annual Increase	\$3,956	\$14,538	\$25,331	\$34,558	\$42,581	\$120,964
Max Net Benefits	\$4,676	\$16,237	\$26,042	\$33,629	\$39,877	\$120,462
Total Cost = Total Benefit	\$4,932	\$16,823	\$26,699	\$34,971	\$41,911	\$125,336

Breakdown of costs and benefits including safety for the preferred alternative

Prior to this point, the societal costs of safety have not been included in the summary tables, since they are considered a worst case estimate, and the other estimates in the analysis represent our best estimates. Tables X-6 and X-7 provides a breakdown of the costs and benefits for the preferred alternative using a 3 percent and 7 percent discount rate, respectively, when we include the worst case safety estimates.

Table X-6
Preferred alternative
Cost and Benefit Estimates
Passenger Cars and Light Trucks Combined
3% Discount Rate

	MY 2012	MY 2013	MY 2014	MY 2015	MY 2016	Total
Technology Costs	\$5,695	\$9,295	\$12,454	\$15,080	\$17,633	\$60,157
Benefits						
Lifetime Fuel Expenditures	\$10,197	\$22,396	\$32,715	\$41,880	\$50,823	\$158,012
Consumer Surplus from Additional Driving	\$751	\$1,643	\$2,389	\$3,029	\$3,639	\$11,451
Refueling Time Value	\$776	\$1,551	\$2,198	\$2,749	\$3,277	\$10,550
Petroleum Market Externalities	\$559	\$1,194	\$1,700	\$2,129	\$2,538	\$8,121
Congestion Costs	(\$460)	(\$934)	(\$1,332)	(\$1,657)	(\$1,991)	(\$6,376)
Noise Costs	(\$7)	(\$14)	(\$21)	(\$26)	(\$31)	(\$99)
Crash Costs	(\$217)	(\$437)	(\$625)	(\$776)	(\$930)	(\$2,985)
CO2	\$1,028	\$2,287	\$3,382	\$4,376	\$5,372	\$16,446
CO	\$0	\$0	\$0	\$0	\$0	\$0
VOC	\$41	\$80	\$108	\$131	\$156	\$518
NOX	\$82	\$132	\$155	\$174	\$200	\$744
PM	\$220	\$438	\$621	\$771	\$904	\$2,956
SOX	\$161	\$345	\$490	\$613	\$731	\$2,341
Total	\$13,132	\$28,680	\$41,781	\$53,394	\$64,687	\$201,676
Net Benefits	\$7,044	\$18,759	\$27,090	\$34,710	\$41,386	\$128,992

Table X-7
Preferred alternative
Cost and Benefit Estimates
Passenger Cars and Light Trucks Combined
7% Discount Rate

	MY 2012	MY 2013	MY 2014	MY 2015	MY 2016	Total
Technology Costs	\$5,695	\$9,295	\$12,454	\$15,080	\$17,633	\$60,157
Benefits						
Lifetime Fuel Expenditures	\$7,991	\$17,671	\$25,900	\$33,264	\$40,478	\$125,305
Consumer Surplus from Additional Driving	\$590	\$1,301	\$1,896	\$2,412	\$2,904	\$9,102
Refueling Time Value	\$624	\$1,249	\$1,770	\$2,215	\$2,642	\$8,500
Petroleum Market Externalities	\$448	\$960	\$1,367	\$1,712	\$2,043	\$6,531
Congestion Costs	(\$371)	(\$753)	(\$1,074)	(\$1,335)	(\$1,606)	(\$5,138)
Noise Costs	(\$6)	(\$12)	(\$16)	(\$21)	(\$24)	(\$80)
Crash Costs	(\$173)	(\$352)	(\$503)	(\$626)	(\$749)	(\$2,403)
CO2	\$797	\$1,781	\$2,634	\$3,410	\$4,189	\$12,813
CO	\$0	\$0	\$0	\$0	\$0	\$0
VOC	\$33	\$65	\$87	\$106	\$125	\$416
NOX	\$60	\$99	\$120	\$135	\$156	\$570
PM	\$170	\$344	\$492	\$613	\$721	\$2,339
SOX	\$129	\$278	\$394	\$493	\$588	\$1,882
Total	\$10,292	\$22,631	\$33,066	\$42,380	\$51,468	\$159,837
Net Benefits	\$4,281	\$12,832	\$18,818	\$24,414	\$29,293	\$89,638

Payback Period

The “payback period” represents the length of time required for a vehicle buyer to recoup, through savings in fuel use, the higher cost of purchasing a more fuel-efficient vehicle. Thus, only these two factors are considered (purchase price and fuel savings). When a higher CAFE standard requires a manufacturer to improve the fuel economy of some of its vehicle models, the manufacturer’s added costs for doing so are reflected in higher prices for these models. While buyers of these models pay higher prices to purchase these vehicles, their improved fuel economy lowers the consumer’s costs for purchasing fuel to operate them. Over time, buyers may recoup the higher purchase prices they pay for these vehicles in the form of savings in outlays for fuel. The length of time required to repay the higher cost of buying a more fuel-efficient vehicle is referred to as the buyer’s payback period.

The length of this payback period depends on the initial increase in a vehicle’s purchase price, the improvement in its fuel economy, the number of miles it is driven each year, and the retail price of fuel. We calculated payback periods using the fuel economy improvement and average price increase estimated to result from the standard, the future retail gasoline prices, and estimates of the number of miles vehicles are driven each year as they age. These calculations are taken from a consumer’s perspective, not a societal perspective. Thus, only gasoline savings are included on the benefits side of the equation. The price of gasoline includes fuel taxes and future savings are not discounted to present value, since consumers generally only consider and respond to what they pay at the pump. The payback periods are estimated as an average for all manufacturers for the different alternatives. The payback periods for MY 2016 are shown in Table X-8.

Table X-8
Payback Period for MY 2016 Average Vehicles
(in years)

	Passenger Cars	Light Trucks
Preferred Alternative	3.5	2.5
3% Annual Increase	2.8	2.1
4% Annual Increase	3.0	2.5
5% Annual Increase	3.6	3.3
6% Annual Increase	4.3	3.7
7% Annual Increase	4.6	4.2
Max Net Benefits	4.4	3.9
Total Cost = Total Benefit	4.6	4.1

Sensitivity Analyses

The agency has performed several sensitivity analyses to examine important assumptions. We examine sensitivity with respect to the following four economic parameters:

- 1) The price of gasoline: The main analysis (i.e., the Reference Case) uses the AEO 2009 reference case estimate for the price of gasoline (see Table VIII-4). In this sensitivity analysis we examine the effect of using the AEO high or low forecast estimates instead.
- 2) The rebound effect: The main analysis uses a rebound effect of 10% to project increased miles traveled as the cost per mile driven decreases. In the sensitivity analysis, we examine the effect of using a 5% or 15% rebound effect instead.
- 3) The values of CO₂ benefits and monopsony: The main analysis uses \$20 per ton to quantify the benefits of reducing CO₂ emissions and \$0.178 per gallon to quantify the benefits of reducing fuel consumption. In the sensitivity analysis, we examine the effect of using values of \$5, \$10, \$34, or \$56 per ton instead to value CO₂ benefits. These values can be translated into cents per gallon by multiplying by 0.0089³⁰⁶, giving the following values:

(\$5 per ton CO₂) x 0.0089 = \$0.0445 per gallon
 (\$10 per ton CO₂) x 0.0089 = \$0.089 per gallon
 (\$20 per ton CO₂) x 0.0089 = \$0.178 per gallon
 (\$34 per ton CO₂) x 0.0089 = \$0.3026 per gallon
 (\$56 per ton CO₂) x 0.0089 = \$0.4984 per gallon

The \$5 per ton value reflects the domestic impacts of CO₂ emissions and so we use a nonzero monopsony cost, namely \$0.30 cents per gallon, when valuing CO₂ emissions at \$5 per ton. The higher per-ton values of CO₂ emissions reflect the global impacts of CO₂ emissions and we so use \$0 per gallon for monopsony in these cases.

- 4) Military security: The main analysis \$0 per gallon to quantify the military security benefits of reducing fuel consumption. In the sensitivity analysis, we examine the impact of using a value of 5 cents per gallon instead.

In addition, we will separately examine the sensitivity of the benefits of reducing criteria pollutants and vehicle safety to alternate values of statistical life.

Varying each of the above 5 parameters in isolation results in 10 economic scenarios, not including the Reference case. These are listed in Table X-9 below, together with two additional scenarios that use values for these parameters that produce the lowest and highest valued benefits.

³⁰⁶ The molecular weight of Carbon (C) is 12, the molecular weight of Oxygen (O) is 16, thus the molecular weight of CO₂ is 44. One ton of C = 44/12 tons CO₂ = 3.67 tons CO₂. 1 gallon of gas weighs 2,819 grams, of that 2,433 grams are carbon. \$1.00 CO₂ = \$3.67 C and
 \$3.67/ton * ton/1000kg * kg/1000g * 2433g/gallon = (3.67 * 2433) / 1000 * 1000 = \$0.0089/gallon

Table X-9
Sensitivity Analyses

Name	Fuel Price	Discount Rate	Rebound Effect	SCC	Monopsony Effect	Military Security
Reference	Reference	3%	10%	\$20	0¢/gal	0¢/gal
High Fuel Price	High	3%	10%	\$20	0¢/gal	0¢/gal
Low Fuel Price	Low	3%	10%	\$20	0¢/gal	0¢/gal
7% Discount Rate	Reference	7%	10%	\$20	0¢/gal	0¢/gal
5% Rebound Effect	Reference	3%	5%	\$20	0¢/gal	0¢/gal
15% Rebound Effect	Reference	3%	15%	\$20	0¢/gal	0¢/gal
\$56/ton CO2 Value	Reference	3%	10%	\$56	0¢/gal	0¢/gal
\$34/ton CO2	Reference	3%	10%	\$34	0¢/gal	0¢/gal
\$10/ton CO2	Reference	3%	10%	\$10	0¢/gal	0¢/gal
\$5/ton CO2	Reference	3%	10%	\$5	30¢/gal	0¢/gal
5¢/gal Military Security Value	Reference	3%	10%	\$20	0¢/gal	5¢/gal
Lowest Discounted Benefits	Low	7%	15%	\$5	0¢/gal	0¢/gal
Highest Discounted Benefits	High	3%	5%	\$56	0¢/gal	5¢/gal

For these cases, sensitivity analyses were performed on the Preferred Alternative only. Table X-10 presents the achieved fuel economy, per-vehicle price increase, total benefits, total cost, lifetime fuel savings, and the lifetime reductions in CO₂ emissions that would result under the standards from the 13 economic scenarios. For the achieved fuel economy and per-vehicle price increase, the table presents only the model year 2016 results, since this model year showed the greatest impacts. The results are not very sensitive to the assumptions used, with the low fuel price and discount rates being the only assumptions that make noticeable differences. For benefits, costs, fuel savings, and CO₂ emissions reductions, the table presents totals over the five model years, rather than their values for MY 2016, to reflect the total impact of the standards that would result from the various economic assumptions.

Table X-11 presents the percentage changes from the Reference economic assumptions for the items in Table X-10. For instance, using AEO's High fuel price forecast instead of its Reference forecast for the price of fuel in the Volpe model would result in passenger car standards with 36% higher benefits.

From Table X-11, we conclude the following regarding the impact of varying the economic parameters among the considered values:

- 1) The various economic assumptions have similar effects on the passenger car and light truck standards.
- 2) Varying the economic assumptions has virtually no impact on achieved fuel economy.
- 3) The economic parameter with the greatest impact is fuel price. Changing the fuel price forecast to AEO's High or Low forecasts impacts benefits by about +/- 37%. However the impact of fuel price on other quantities, such as cost, is much smaller, resulting in increases or decreases of 3-8%.
- 4) Economic parameters other than fuel price and the rebound effect had no effect on per-vehicle cost, total cost, fuel savings, or CO2 reductions. Their impacts on benefits were 6% or less, with the exception of the 7% discount rate, which decreased benefits by 20%, and the \$56/ton CO2 value, which raised benefits by 14%.
- 5) Changing all economic parameters simultaneously (among the considered values) changes benefits by at most about 60%. However impacts to other quantities, such as cost, are much smaller, resulting in increases or decreases of 6% or less.
- 6) Impacts other than those discussed in 1) through 5) were small (5% or less).

Regarding the lower fuel savings and CO2 emissions reductions predicted by the sensitivity analysis as fuel price increases, which initially may seem counterintuitive, note that there are some counterbalancing factors occurring. As fuel price increases, people will drive less and so fuel savings and CO2 emissions reductions may decrease.

Table X-10
Sensitivity Analyses
(mpg, Per-Vehicle Cost, Total Benefits, Total Cost, Fuel Saved, & CO2 Emissions Reduced)

Economic Assumptions	MY 2016 Achieved mpg	MY 2016 Per-Vehicle Cost	MY 2012-2016 Benefits, Discounted 3%, in Millions of \$	MY 2012-2016 Cost (Societal Perspective), in Millions of \$	MY 2012-2016 Fuel Saved, in Millions of Gallons	MY 2012-2016 CO2 Emissions Reduced, in mmT
Passenger Cars						
Reference	37.6	\$1,085	\$119,096	\$40,781	36,040	381
High Fuel Price	37.6	\$1,113	\$161,485	\$42,266	35,421	375
Low Fuel Price	37.3	\$1,017	\$73,632	\$38,365	36,889	391
5% Rebound Effect	37.6	\$1,085	\$124,380	\$40,781	37,671	399
15% Rebound Effect	37.6	\$1,085	\$113,812	\$40,781	34,408	363
\$56/ton CO2 Value	37.6	\$1,085	\$136,278	\$40,781	36,040	381
\$34/ton CO2	37.6	\$1,085	\$125,778	\$40,781	36,040	381
\$10/ton CO2	37.6	\$1,085	\$114,323	\$40,781	36,040	381
\$5/ton CO2	37.6	\$1,085	\$111,937	\$40,781	36,040	381
5¢/gal Military Security Value	37.6	\$1,085	\$120,516	\$40,781	36,040	381
Lowest Discounted Benefits	37.3	\$1,017	\$49,949	\$38,365	35,213	372
Highest Discounted Benefits	37.6	\$1,113	\$186,434	\$42,266	37,024	393
Light Trucks						
Reference	28.1	\$1,058	\$82,580	\$19,376	25,559	275
High Fuel Price	28.1	\$1,130	\$108,474	\$20,536	24,244	257
Low Fuel Price	28.0	\$1,024	\$50,482	\$17,821	25,912	281
5% Rebound Effect	28.1	\$1,058	\$85,801	\$19,376	26,761	289
15% Rebound Effect	28.1	\$1,058	\$79,359	\$19,376	24,357	262
\$56/ton CO2 Value	28.1	\$1,058	\$95,001	\$19,376	25,559	275
\$34/ton CO2	28.1	\$1,058	\$87,410	\$19,376	25,559	275
\$10/ton CO2	28.1	\$1,058	\$79,130	\$19,376	25,559	275
\$5/ton CO2	28.1	\$1,058	\$77,405	\$19,376	25,559	275
5¢/gal Military Security Value	28.1	\$1,058	\$83,561	\$19,376	25,559	275
Lowest Discounted Benefits	28.0	\$1,024	\$33,797	\$17,821	24,694	268
Highest Discounted Benefits	28.1	\$1,130	\$125,081	\$20,536	25,387	269
Passenger Cars & Light Trucks						

Economic Assumptions	MY 2016 Achieved mpg	MY 2016 Per-Vehicle Cost	MY 2012-2016 Benefits, Discounted 3%, in Millions of \$	MY 2012-2016 Cost (Societal Perspective), in Millions of \$	MY 2012-2016 Fuel Saved, in Millions of Gallons	MY 2012-2016 CO2 Emissions Reduced, in mmT
Combined						
Reference	37.6	\$1,085	\$119,096	\$40,781	36,040	381
High Fuel Price	37.6	\$1,113	\$161,485	\$42,266	35,421	375
Low Fuel Price	37.3	\$1,017	\$73,632	\$38,365	36,889	391
5% Rebound Effect	37.6	\$1,085	\$124,380	\$40,781	37,671	399
15% Rebound Effect	37.6	\$1,085	\$113,812	\$40,781	34,408	363
\$56/ton CO2 Value	37.6	\$1,085	\$136,278	\$40,781	36,040	381
\$34/ton CO2	37.6	\$1,085	\$125,778	\$40,781	36,040	381
\$10/ton CO2	37.6	\$1,085	\$114,323	\$40,781	36,040	381
\$5/ton CO2	37.6	\$1,085	\$111,937	\$40,781	36,040	381
5¢/gal Military Security Value	37.6	\$1,085	\$120,516	\$40,781	36,040	381
Lowest Discounted Benefits	37.3	\$1,017	\$49,949	\$38,365	35,213	372
Highest Discounted Benefits	37.6	\$1,113	\$186,434	\$42,266	37,024	393

Table X-11
Sensitivity Analyses – Percentage Change from the Reference Case

Economic Assumptions	MY 2016 Required mpg	MY 2016 Per-Vehicle Cost	MY 2012-2016 Benefits, Discounted 3%, in Millions of \$	MY 2012-2016 Cost (Societal Perspective), in Millions of \$	MY 2012-2016 Fuel Saved, in Millions of Gallons	MY 2012-2016 CO2 Emissions Reduced, in mmT
Passenger Cars						
Reference	Base	Base	Base	Base	Base	Base
High Fuel Price	0%	3%	36%	4%	-2%	-2%
Low Fuel Price	-1%	-6%	-38%	-6%	2%	3%
5% Rebound Effect	0%	0%	4%	0%	5%	5%
15% Rebound Effect	0%	0%	-4%	0%	-5%	-5%
\$56/ton CO2 Value	0%	0%	14%	0%	0%	0%
\$34/ton CO2	0%	0%	6%	0%	0%	0%
\$10/ton CO2	0%	0%	-4%	0%	0%	0%
\$5/ton CO2	0%	0%	-6%	0%	0%	0%
5¢/gal Military Security Value	0%	0%	1%	0%	0%	0%
Lowest Discounted Benefits	-1%	-6%	-58%	-6%	-2%	-2%
Highest Discounted Benefits	0%	3%	57%	4%	3%	3%
Light Trucks						
Reference	Base	Base	Base	Base	Base	Base
High Fuel Price	0%	7%	31%	6%	-5%	-7%
Low Fuel Price	0%	-3%	-39%	-8%	1%	2%
5% Rebound Effect	0%	0%	4%	0%	5%	5%
15% Rebound Effect	0%	0%	-4%	0%	-5%	-5%
\$56/ton CO2 Value	0%	0%	15%	0%	0%	0%
\$34/ton CO2	0%	0%	6%	0%	0%	0%
\$10/ton CO2	0%	0%	-4%	0%	0%	0%
\$5/ton CO2	0%	0%	-6%	0%	0%	0%
5¢/gal Military Security Value	0%	0%	1%	0%	0%	0%
Lowest Discounted Benefits	0%	-3%	-59%	-8%	-3%	-3%
Highest Discounted Benefits	0%	7%	51%	6%	-1%	-2%
Passenger Cars & Light Trucks Combined						

Economic Assumptions	MY 2016 Required mpg	MY 2016 Per-Vehicle Cost	MY 2012-2016 Benefits, Discounted 3%, in Millions of \$	MY 2012-2016 Cost (Societal Perspective), in Millions of \$	MY 2012-2016 Fuel Saved, in Millions of Gallons	MY 2012-2016 CO2 Emissions Reduced, in mmT
Reference	Base	Base	Base	Base	Base	Base
High Fuel Price	0%	3%	36%	4%	-2%	-2%
Low Fuel Price	-1%	-6%	-38%	-6%	2%	3%
5% Rebound Effect	0%	0%	4%	0%	5%	5%
15% Rebound Effect	0%	0%	-4%	0%	-5%	-5%
\$56/ton CO2 Value	0%	0%	14%	0%	0%	0%
\$34/ton CO2	0%	0%	6%	0%	0%	0%
\$10/ton CO2	0%	0%	-4%	0%	0%	0%
\$5/ton CO2	0%	0%	-6%	0%	0%	0%
5¢/gal Military Security Value	0%	0%	1%	0%	0%	0%
Lowest Discounted Benefits	-1%	-6%	-58%	-6%	-2%	-2%
Highest Discounted Benefits	0%	3%	57%	4%	3%	3%

In addition, the agency analyzed the impact that having a retail price equivalent (RPE) factor of 1.5 for all technologies would have on the various alternatives instead of using the indirect cost methodology (ICM), with special attention being paid to the preferred alternative and the maximum net benefit alternative. Table X-12 shows the impact on the MY 2016 achieved mpg level for passenger cars and light trucks by changing the cost markup factors used in the Volpe model. The big difference is in passenger car mpg for the maximum net benefit alternative. Having a higher cost for technologies limits how many technologies are cost effective for passenger cars and has no real impact on light trucks. Table X-13 shows the impacts on costs and benefits for the preferred alternative.

Table X-12
Achieved mpg level
Comparing Different Cost Mark-up Methodologies
(Achieved mpg levels)

	ICM Method (Main analysis)	RPE Method (Sensitivity)	Difference (mpg)
Passenger Car Preferred Alternative	37.56	37.48	0.08
Passenger Car Maximum Net Benefits Alternative	39.89	39.25	0.64
Light Truck Preferred Alternative	28.09	28.01	.08
Light Trucks Maximum Net Benefits Alternative	30.26	30.27	+0.00

Table X-13
Sensitivity Analyses
(mpg, Per-Vehicle Cost, Total Benefits, Total Cost, Fuel Saved, & CO2 Emissions Reduced)

Economic Assumptions	MY 2016 Achieved mpg	MY 2016 Per-Vehicle Cost	MY 2012-2016 Benefits, Discounted 3%, in Millions of \$	MY 2012-2016 Cost (Societal Perspective), in Millions of \$	MY 2012-2016 Fuel Saved, in Millions of Gallons	MY 2012-2016 CO2 Emissions Reduced, in mmT
Passenger Cars						
Reference	37.56	\$1,085	\$119,096	\$40,781	36,040	381
1.5 RPE	37.48	\$1,287	\$114,413	\$47,781	34,587	365
Light Trucks						
Reference	28.09	\$1,058	\$82,580	\$19,376	25,559	275
1.5 RPE	28.01	\$1,308	\$108,474	\$23,472	24,324	258

Sensitivity Analysis, Value of Statistical Life

The value associated with preventing a fatality is measured by the Value of a Statistical Life (VSL), defined as the value of preventing one random fatality among a population at risk. The Office of Management and Budget (OMB) reviews and approves regulations issued from numerous agencies including DOT, EPA, OSHA, CPSC, etc., and issues guidance for agencies to use in analyzing the impacts of their regulations. Although OMB guidance generally seeks to ensure a level of consistency in the issues addressed by various regulatory agencies, they have not established a common VSL for use across all government agencies. Instead, OMB

recommends that each agency develop and justify its own VSL. As a result, different agencies assign different values to saving a life in their regulations.

The Department of Transportation (DOT) has issued a series of guidance memos for the various modes within the department. In February 2008, DOT established a VSL of \$5.8 million with supplementary calculations at \$3.2 million and \$8.4 million in recognition of uncertainty found over a range of studies (these figures are measured in 2007 dollars). Although DOT recently revised its central estimate of VSL to \$6.0 million, this figure is denominated in 2008 dollars, and when adjusted to 2007 dollars remains at \$5.8 million.

By contrast, EPA uses VSL of \$7.6 million, which is 30% higher than DOT's central estimate, although still within the upper estimate recommended by DOT to recognize uncertainty. The differing VSLs across agencies should be judged as arising from different conclusions regarding the validity of the various studies on VSL, rather than a function of the different at-risk populations that they represent.

Within the CAFE PRIA, VSL is used for two different purposes, once to value benefits-per-ton from reducing emissions of criteria pollutants in Chapter VIII, and once to value potential safety impacts in Chapter IX. The potential safety impacts calculation is discussed outside the VOLPE model, in order to emphasize the uncertainty surrounding this issue. It is examined separately and put in context of the overall net benefits derived from the VOLPE model. The basic conclusion is that the safety impacts are highly uncertain, but, even under the worst case assumption, the rule would still be highly cost-beneficial using the DOT VSL of \$5.8 million.

The benefits-per-ton values for reducing emissions of criteria pollutants were derived by EPA for use by both EPA and NHTSA in this rulemaking activity. These estimates were based on an estimate of VSL derived previously by EPA and reported in its *Guidelines for Preparing Economic Analyses* (see Technical Support Document, Section 4.B.11.b).³⁰⁷ This estimate is \$6.3 million in 2000 dollars, which corresponds to \$7.6 million when expressed in 2007 dollars. NHTSA agreed to use the estimates of per-ton benefits from reducing air pollutant emissions derived by EPA in this rulemaking, despite their reliance on a VSL estimate higher than that endorsed by DOT.

As noted in the DOT guidance, however, the uncertainty surrounding the VSL is notable, and should be recognized in regulatory analyses. Accordingly, NHTSA has prepared this sensitivity analysis, which examines the values of both safety mortality impact and mortality benefits from reducing criteria pollutant emissions under the complete range of DOT VSL values, as well as the EPA value. Table X-14 summarizes these estimates:

³⁰⁷ U.S. Environmental Protection Agency (U.S. EPA). 2000. *Guidelines for Preparing Economic Analyses*. EPA 240-R-00-003. National Center for Environmental Economics, Office of Policy Economics and Innovation. Washington, DC. September. Available at [http://yosemite.epa.gov/ee/epa/eed.nsf/webpages/Guidelines.html/\\$file/cover.pdf](http://yosemite.epa.gov/ee/epa/eed.nsf/webpages/Guidelines.html/$file/cover.pdf).

Table X-14
Sensitivity Analysis of Alternate VSLs (millions of 2007\$, MYs 2012-2016)

Assumed VSL (2007\$)	Source	Value of Worst Case Fatality Impacts ³⁰⁸	Value of Mortality Benefits from Reduced Emissions of Criteria Air Pollutants
\$3.2 million	DOT Lower Estimate	\$3,808	\$3,125
\$5.8 million	DOT Central Estimate	\$6,637	\$5,185
\$7.6 million	EPA Estimate	\$8,595	\$6,557
\$8.4 million	DOT Upper Estimate	\$9,466	\$7,194

As mentioned above, the safety impacts are highly uncertain and are not used in the VOLPE model. Although the criteria pollutants benefits are used in the VOLPE model, their impact is very small. Specifically, benefits from reducing premature mortality account for 90-91% of EPA's estimates of total benefits from reducing criteria emissions, depending on the specific pollutant. DOT's estimate of the VSL is 23% lower than the estimate used by EPA to construct the per-ton benefits of reducing emissions, which means that substituting DOT's estimate of VSL would reduce the per-ton benefits estimates by 21% (23% of 90-91%). Our estimates of the total benefits from reducing emissions of criteria air pollutants would be reduced by this same percentage. Since these represent 3.1-3.3% of total benefits from the proposed standards, making this change would reduce total benefits by 0.7% (21% of 3.0-3.3%).

³⁰⁸ Note that calculations for safety impacts are based on Comprehensive costs, which include economic impacts in addition to VSL estimates, such as medical care costs, legal costs, insurance administrative costs, etc. These costs are based on previous NHTSA studies of motor vehicle crash costs, and add \$300,000 to each VSL. However, costs associated with nonfatal injuries are not accounted for in this calculation.

XI. FLEXIBILITIES IN MEETING THE STANDARD

Consistent with the Energy Independence and Security Act (EISA), the NPRM not only proposed new CAFE standards for passenger cars and light trucks, but also revised provisions regarding the creation and application of CAFE credits. In this context, CAFE credits refer to flexibilities allowed under the Energy Policy and Conservation Act (EPCA) provisions governing use of Alternative Motor Fuels Act (AMFA) credits, allowable banked credits, and transfers of credits between the car and truck fleets allowed under EISA. Finally, there are additional flexibilities to transfer credits between manufacturing companies. Because EPCA prohibits NHTSA from considering these flexibilities when determining the stringency of CAFE standards, NHTSA did not consider these flexibilities when it developed alternatives for this rulemaking.

Under the EISA, AMFA credits are being phased out. The allowable credits are reduced so that by 2020 such credits will no longer be allowed under law. However, AMFA credits are allowed during the years affected by this rulemaking. Manufacturers building dual-fuel vehicles are entitled to a CAFE benefit of up to 1.2 mpg in 2012 to 2014, 1.0 mpg in 2015, and 0.8 mpg in 2016 for each fleet. NHTSA estimates that the impact of the use of AMFA credits could result in an average reduction of approximately 0.9 mpg in achieved average fuel economy in model years 2012 through 2016, and a related increase in CO₂ emissions.

Regarding other than AMFA credits (*e.g.*, CAFE credits earned through over-compliance, credits transferred between fleets, and credits acquired from other manufacturers), we do not have a sound basis to predict the extent to which manufacturers might use them, particularly since the credit transfer and credit trading programs have been only recently authorized, and credit transfers could involve complex interactions with multiyear planning.³⁰⁹

Such questions are similar to, though possibly less tractable than the behavioral and strategic questions that were entailed in representing manufacturers' ability to "pull ahead" the implementation of some technologies, and that would be involved in attempting to estimate CAFE-induced changes in market shares. Although the Volpe model has been modified to account for multiyear planning effects, substantial concerns remain about how to develop a credible market share model for integration into the modeling system NHTSA has used to analyze the costs and effects of credit transfers and credit trading.

We believe that some manufacturers are likely to take advantage of these flexibility mechanisms, thereby reducing benefits and costs. Some manufacturers make substantial use of the carry forward and carry back credit flexibilities today. Many manufacturers make dual fuel vehicles today and earn credits. These vehicles are in their MY 2008 and MY 2011 baselines. Other manufacturers regularly exceed CAFE standards applicable to one or both fleets, and allow the corresponding excess CAFE credits to expire. Finally, still other manufacturers regularly pay civil penalties for noncompliance, even when producing dual-fuel vehicles would substantially reduce the magnitude of those penalties.

³⁰⁹ For example, if a manufacturer is planning to redesign many vehicles in MY 2013, but few vehicles in MY 2015 when standards will also be significantly more stringent, the benefits (in terms of reducing regulatory burden) of using some flexibilities in MY 2013 (*e.g.*, credit transfers) could be outweighed by the benefits of applying extra technologies in MY 2013 in order to carry them forward to facilitate compliance in MY 2015.

There are vehicle costs to provide the dual fuel capability of using either E85 or gasoline. These costs are incremental to the average vehicle costs of a gasoline vehicle. The additional or redesigned components necessary for E85 capability may include:

- Flexible Fuel Sensor or Oxygen Sensor - Determines the amount of ethanol in the fuel and adjusts the engine operating parameters.
- Fuel System - Plastic Gas Tank, updating components like seals and gaskets to be ethanol capable, increased vapor storage capacity, and some fuel system materials may be changed to stainless steel because ethanol in E-85 is corrosive.
- Low Emission Hardware or Improved Evaporative Emission Systems
- Fuel Injectors and Pressure Regulators
- Valve Seat Materials and Rings
- Fuel Rail Changes to allow for increased fuel pressure
- Cold start enhancement

Combined, the agency estimates that these needed improvements would increase the consumer cost of a vehicle by \$100 to \$175 (in \$2007), even though the manufacturers are charging the same price for a dual-fueled automobile as for a gasoline powered vehicle. The analysis did not include a cost for dual-fueled vehicles because for the most part they are already in the MY 2011 adjusted baseline.

We expect that use of flexibilities would tend to be greater under more stringent standards. As stringency increases, the potential for manufacturers to face greater cost increases, and for some, depending on its level of technological implementation, costs could rise substantially. The economic advantage of employing allowed flexibilities increases and could affect manufacturer behavior in this regard. A critical factor in addressing the fuel and emissions impacts of such flexibilities is that the likely extent of utilization cannot be assumed constant across the alternatives.

To gauge the potential upper end of differences that could result from these provisions, the agency has used the Volpe model to estimate costs and effects if every manufacturer is assumed to take full advantage of the FFV credit provisions throughout MY 2012-2016, under both the baseline (MY 2011) and proposed standards. The analysis indicates that full use of the provisions could (a) reduce the average achieved fuel economy by 0.7 in MY 2016, and by 0.6-1.0 mpg in earlier model years, (b) reduce technology outlays by about \$15 billion (24%) during MY 2012-2016, (c) reduce average price increases by \$180-\$208 during MY 2012-2016, (d) reduce fuel saved during MY 2012-2016 by about 1.1 billion gallons (1.8%), and (e) slightly increase (by about 1 mmt, or 0.15%) CO₂ emissions avoided during MY 2012-2016.^{310,311} Table XI-1 shows those potential impacts on passenger cars and light trucks combined. The achieved fuel economy of the fleet and costs are lower if you don't consider the credits from

³¹⁰ Estimated differences in costs and prices do not include incremental costs to produce FFVs.

³¹¹ With FFV credits, our analysis includes application of diesel engines at lower volumes than when FFV credits are excluded. Because diesel fuel contains more carbon than gasoline, this difference in diesel application causes a slight reduction in CO₂ emissions.

dual-fueled vehicles. We could show many tables supporting these estimates, but we chose just to show some summary highlights.

Table XI-1
Potential Impact of Dual-Fueled Vehicle Credits
Preferred Alternative

	2012	2013	2014	2015	2016	Total
<u>Average Achieved FE (mpg)</u>						
With FFVs	28.8	29.6	30.5	31.8	33.0	
Without FFVs	29.4	30.5	31.5	32.7	33.7	
Difference	(0.6)	(0.9)	(1.0)	(1.0)	(0.7)	
<u>Technology Outlays (\$b)</u>						
With FFVs	4.1	6.7	9.6	12.1	15.0	47.4
Without FFVs	6.5	9.8	12.9	15.4	17.9	62.5
Difference	(2.5)	(3.0)	(3.3)	(3.4)	(2.9)	(15.1)
<u>Price Increases (\$)</u>						
With FFVs	293	436	599	737	912	
Without FFVs	476	635	806	945	1,091	
Difference	(183)	(199)	(208)	(208)	(180)	
<u>Fuel Savings (b. gal.)</u>						
With FFVs	4.7	8.6	12.3	15.4	19.0	60.0
Without FFVs	<u>4.3</u>	<u>8.9</u>	<u>12.8</u>	<u>16.0</u>	<u>19.1</u>	<u>61.1</u>
Difference	0.4	(0.4)	(0.5)	(0.6)	(0.1)	(1.1)
<u>Avoided CO2 (mmt)</u>						
With FFVs	51	94	134	168	207	654
Without FFVs	<u>45</u>	<u>95</u>	<u>137</u>	<u>172</u>	<u>206</u>	<u>653</u>
Difference	7	(1)	(2)	(4)	2	1

XII. PROBABILISTIC UNCERTAINTY ANALYSIS

OMB Circular A-4 requires formal probabilistic uncertainty analysis of complex rules where there are large, multiple uncertainties whose analysis raises technical challenges or where effects cascade and where the impacts of the rule exceed \$1 billion. CAFE meets all of these criteria. This chapter identifies and quantifies the major uncertainties in the preliminary regulatory impact analysis and estimates the probability distribution of the benefits, costs, and net benefits of the compliance options selected for the proposed rule for MY 2012-2016 passenger car and light truck CAFE standards. Throughout the course of the main analysis, input values were selected from a variety of often conflicting sources. Best estimates were selected based on the preponderance of data and analyses available, but there is inevitably a level of uncertainty in these selections. Some of these inputs contributed less to the overall variations of the outcomes, and, thus, are less significant. Some inputs depend on others or are closely related (e.g. oil import externalities), and thus can be combined. With the vast number of uncertainties imbedded in this regulatory analysis, this uncertainty analysis identifies only the major independent uncertainty factors having appreciable variability and impact on the end results and quantifies them by their probability distributions. These newly defined values are then randomly selected and fed back into the model to determine the net benefits using the Monte Carlo statistical simulation technique.³¹² The simulation technique induces the probabilistic outcomes accompanied with degrees of probability or plausibility. This facilitates a more informed decision-making process.

The analysis is based on the actual processes used to derive net benefits as described in the previous chapters. Each variable (e.g., cost of technology) in the mathematical model represents an uncertainty factor that would potentially alter the modeling outcomes if its value was changed. We assume that these variables are independent of each other. The confidence intervals around the costs and benefits of technologies reflect independent levels of uncertainty regarding costs and benefits, rather than linked probabilities dependent on higher or lower quality versions of a specific technology.

The uncertainties of these variables are described by appropriate probability distribution functions based on available data. If data are not sufficient or not available, professional judgments are used to estimate the probability distributions of these uncertainty factors. A complete description of the formulas and methods used in the CAFE model is available in the public docket.³¹³

After defining and quantifying the major uncertainty factors, the next step is to simulate the model to obtain probabilistic results rather than single-value estimates. In the uncertainty analysis, CAFE levels were kept constant; in other words, we did not change the CAFE standards for each run based on net benefits. The simulation process was run repeatedly for 20,000 trials under each discount rate scenario. Each complete run is a trial. For each trial, the

³¹² See, for example, Morgan, MG, Henrion, M, and Small M, "Uncertainty: A Guide to Dealing with Uncertainty in Quantitative Risk and Policy Analysis", Cambridge University Press, 1990.

³¹³ CAFE Compliance and Effects Modeling System Documentation, Volpe Center, U.S. Dept. of Transportation, July 2005, pp. 27-46 and C-22 to C-35. Docket No. NHTSA 21974-2.

simulation first randomly selects a value for each of the uncertainty factors based on their probability distributions. The selected values are then fit into the models to forecast results. In addition to the simulation results, the program also estimates the degree of certainty (or confidence, credibility). The degree of certainty provides the decision-maker with an additional piece of important information with which to evaluate the forecast results.

Simulation Models and Uncertainty Factors

A Monte Carlo simulation was conducted using the CAFE modeling system that was developed to estimate the impacts of higher CAFE requirements described in previous chapters. The focus of the simulation model was variation around the chosen uncertainty parameters and their resulting impact on the key output parameters, fuel savings, and net benefits. Net benefits measure the difference between (1) the total dollar value that would be saved in fuel and other benefits and (2) the total costs of the rule.

The agency reviewed the inputs and relationships that drive the CAFE model to determine the factors that are the major sources of uncertainty. Five factors were identified as contributing the most uncertainty to the estimated impacts of higher CAFE standards:

- (1) Technology costs;
- (2) Technology effectiveness;
- (3) Fuel prices;
- (4) The value of oil consumption externalities;
- (5) Greenhouse gas emissions and;
- (6) The rebound effect.

Technology Costs

The costs incurred by manufacturers to modify their vehicles to meet new CAFE levels are assumed to be passed on to consumers in the form of higher new car prices. These technology costs are the primary determinant of the overall cost of improving fuel economy.

Thirty-nine different technologies were examined as possible methods to comply with higher CAFE standards. These technologies were summarized in Chapter V earlier in this analysis. The expected values were used in the main analysis. For the uncertainty analysis the technology complexity ratings that were developed to estimate markup factors were used to distinguish between levels of uncertainty that are expected from technologies that are relatively simple and those that are more uncertain. These ratings were designated as Low, Medium, and High based on the characteristics of each specific technology. This approach assumes that low complexity technologies would tend to have mature costs with well known and understood supply chains, resource availability, and manufacturing techniques, which would imply a more narrow range of potential cost variation compared to high complexity technologies, which would have a broader range of uncertainty. This method was adopted because the revised cost estimating procedure adopted for this analysis produced very few cost ranges. In previous analyses of these technologies (see FRIA for MY 2011), cost variation averaging 31% (based on NAS technology estimates) was assumed to represent 3 standard deviations across all technologies. For this

analysis, we are assuming that this average variation represents 2 standard deviations, and applying 1 standard deviation for low complexity technologies, 2 for medium complexity technologies, and 3 standard deviations for high complexity technologies. This results in ranges of 15.5% for low, 31% for medium, and 46.5% for high complexity technologies. The uncertainty model assumes a normal distribution for these cost ranges. Figure XII-1 graphically demonstrates the distributions of a hypothetical sample of three of the technologies.

Figure XII-1
Normal Distributions for 3 Different Technologies

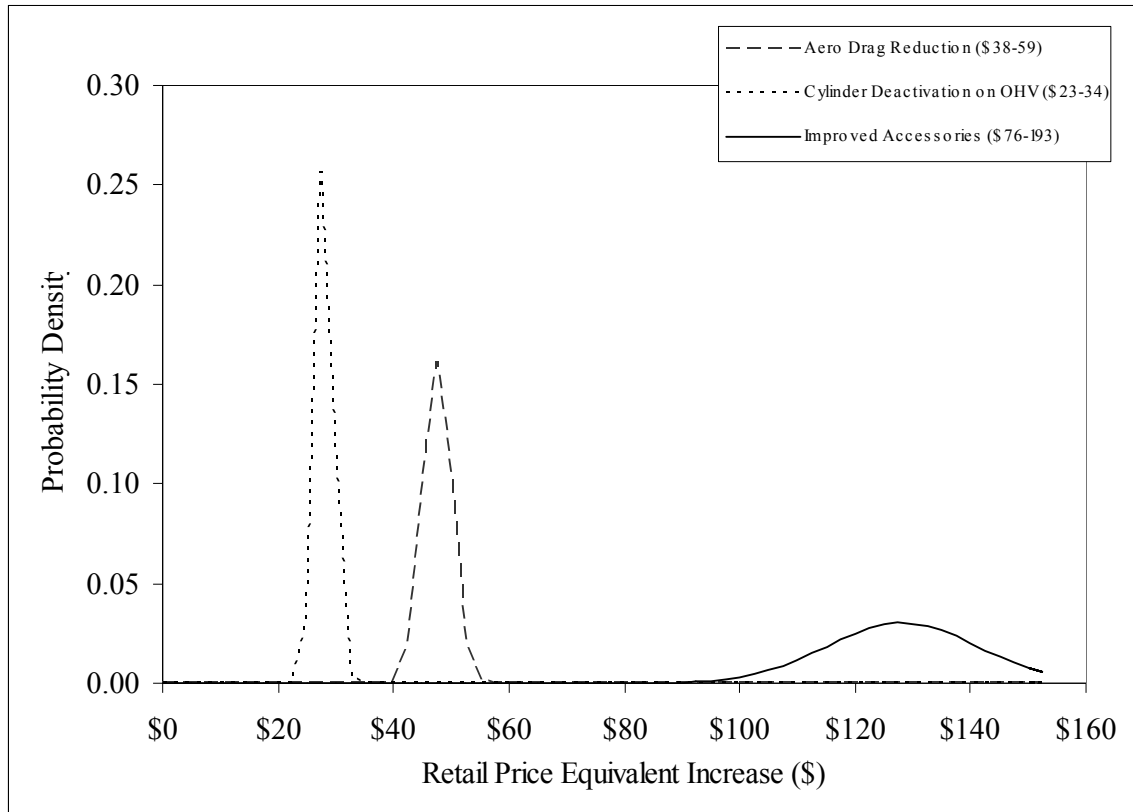

Technology Effectiveness

The modifications adopted by manufacturers to enable their vehicles to meet new CAFE levels will improve fuel efficiency and reduce the cost of operating the more efficient vehicles. The effectiveness of each technology determines how large an impact it will have towards enabling manufacturers to meet the higher CAFE standards, and will thus determine how much additional improvement is needed and which additional technologies will be required to achieve full compliance. In selecting the likely path that manufacturers will choose to meet CAFE, the CAFE model tests the interaction of technology costs and effectiveness to achieve an optimal (cost-minimizing) technological solution. Technology effectiveness is thus a primary determinant of the overall cost and benefit of improving fuel economy.

As noted above, thirty-nine different technologies were examined as possible methods to comply with higher CAFE standards. These technologies were summarized in Chapter V earlier in this analysis. Chapter V also summarizes the estimated range of effectiveness for these technologies.

The expected values (mid-range values) were used in the main analysis. For the uncertainty analysis, the full range of effectiveness estimates is used except where the specified range was regarded as too narrow by expert opinion. These were adjusted to the 'default' range (29%). These technologies are:

- Combustion Restart
- Turbocharging and Downsizing
- Exhaust Gas Recirculation (EGR) Boost
- Conversion to Diesel following CBRST
- Conversion to Diesel following TRBDS
- Dual Clutch or Automated Manual Transmission
- 12V Micro-Hybrid
- Belt mounted Integrated Starter Generator
- Crank mounted Integrated Starter Generator
- Plug-in Hybrid

The fuel consumption improvement ranges were regarded as either tight or were non-existent for these technologies because the values developed for them were not done with a mind toward what the average value should be (by vehicle class) and were not done with an eye towards uncertainty analysis.

As was done with costs, the average variation of all technologies where a range is specified was used as 3 standard deviations to be used as the default variation. For all technologies where there is no range specified, this default variation was used. The uncertainties model assumes a normal distribution for these values, with each end of the range being three standard deviations from the mean (or expected) value.

Fuel Prices

Higher CAFE standards will result in reduced gasoline consumption, which will translate into lower vehicle operating costs for consumers. The value of this reduced fuel consumption is a direct function of fuel prices. Fuel prices are thus a primary determinant of the overall social benefit that will result from improving fuel economy.

The analysis attempts to measure impacts that occur as much as 40 years in the future and estimating gasoline prices this far in advance is an uncertain process. In the main analysis, the agency utilized predicted fuel prices from the Energy Information Administration's (EIA) publication Annual Energy Outlook 2009 (AEO). The main analysis is based on the AEO Reference Case scenario, which represents EIA's best estimate of future fuel prices. For the uncertainty analysis, the Agency examined two other AEO scenarios, the Low Oil Price scenario (LOP) and the High Oil Price scenario (HOP). The LOP scenario was chosen to allow for the possibility that the EIA's Reference Case predictions could overestimate the price of gasoline in the future. However, previous escalation in the price of gasoline resulted in prices that exceeded those estimated by EIA for their reference case. To reflect the possibility of significantly higher prices, the Agency selected the HOP case, which among the AEO 2009 scenarios comes closest to matching the highest prices seen during the recent gasoline price surge, and which gives the highest gasoline price forecasts among all AEO 2009 scenarios

Each of these scenarios was applied as a discrete input (i.e., draws were not made from among the three scenarios separately for each future year). Rather, for each draw, one of the three scenarios was chosen and applied across the full vehicle life for each model year. The probability of selection for each of the three scenarios was modeled using discrete weights of 50 percent for the Reference Case, and 25 percent for both the LOP and HOP cases. Table XII-1 lists the AEO gasoline price forecasts under each scenario. These same prices are demonstrated graphically (in 2007 economics) in Figure XII-2. Note that these prices include Federal, State, and local fuel taxes. For the uncertainty analysis, taxes were removed because they are viewed as transfer payments (see discussion in Chapter VIII). Estimated retail prices are shown here because they are a better reference point for most readers.

Table XII-1
AEO 2009 Gasoline Price Scenarios

Year	Low	Reference	High
2011	\$2.194	\$2.500	\$3.361
2012	\$2.103	\$2.698	\$3.627
2013	\$2.082	\$2.845	\$3.914
2014	\$2.044	\$3.003	\$4.241
2015	\$2.028	\$3.162	\$4.496
2016	\$2.033	\$3.274	\$4.656
2017	\$2.035	\$3.387	\$4.838
2018	\$2.041	\$3.485	\$4.935
2019	\$2.025	\$3.558	\$5.003
2020	\$2.024	\$3.622	\$5.043
2021	\$2.038	\$3.637	\$5.039
2022	\$2.061	\$3.668	\$5.080
2023	\$2.083	\$3.690	\$5.138
2024	\$2.051	\$3.694	\$5.145
2025	\$2.055	\$3.684	\$5.195
2026	\$2.054	\$3.718	\$5.258
2027	\$2.049	\$3.715	\$5.301
2028	\$2.051	\$3.764	\$5.362
2029	\$2.044	\$3.867	\$5.417
2030	\$2.036	\$3.821	\$5.472
2031	\$2.037	\$3.842	\$5.517
2032	\$2.038	\$3.862	\$5.562
2033	\$2.039	\$3.883	\$5.607
2034	\$2.040	\$3.904	\$5.653
2035	\$2.042	\$3.925	\$5.700
2036	\$2.043	\$3.946	\$5.746
2037	\$2.044	\$3.967	\$5.794
2038	\$2.045	\$3.988	\$5.841
2039	\$2.046	\$4.010	\$5.889
2040	\$2.047	\$4.031	\$5.937
2041	\$2.049	\$4.053	\$5.986
2042	\$2.050	\$4.075	\$6.035
2043	\$2.051	\$4.097	\$6.084
2044	\$2.052	\$4.119	\$6.134
2045	\$2.053	\$4.141	\$6.184
2046	\$2.055	\$4.163	\$6.235
2047	\$2.056	\$4.185	\$6.286
2048	\$2.057	\$4.208	\$6.338
2049	\$2.058	\$4.230	\$6.390
2050	\$2.059	\$4.253	\$6.442

Figure XII-2

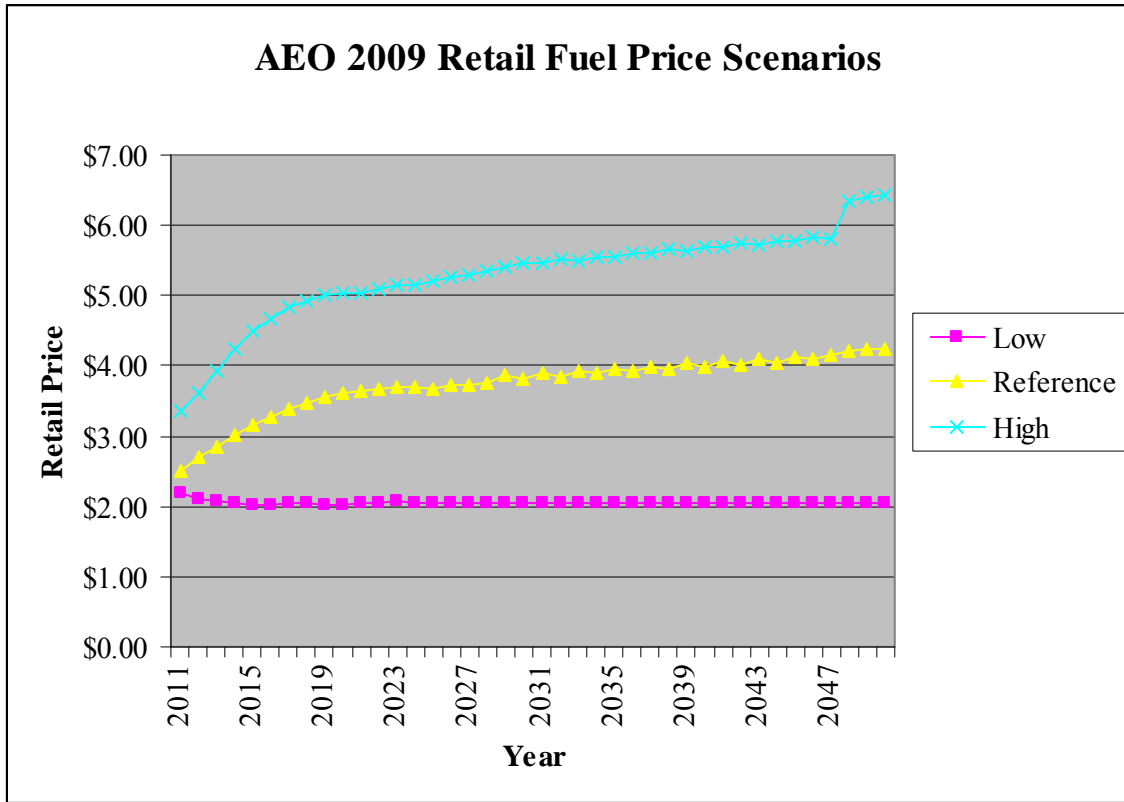

Oil Consumption Externalities

Reduced fuel consumption can benefit society by lowering the world market price for oil, reducing the threat of petroleum supply disruptions, and reducing the cost of maintaining military security in oil producing regions and operating the strategic petroleum reserve. These benefits are called “externalities” because they are not reflected directly in the market price of fuel. A full description of these externalities is included in Chapter VIII under “Other Economic Benefits from Reducing Petroleum Use.” These factors increase the net social benefits from reduced fuel consumption. Although they represent a relatively small portion of overall social benefits, there is a significant level of uncertainty as to their values.

Monopsony costs represent the reduced value of payments from U.S. oil purchasers to foreign oil suppliers that results when lower U.S. oil demand reduces the world price of petroleum, beyond the savings from reduced purchases of petroleum itself.³¹⁴ However, consistency with NHTSA’s use of estimates of the *global* benefits from reducing emissions of CO₂ and other greenhouse gases in this analysis requires the use of a global perspective for assessing their net value. From this perspective, reducing these payments simply results in a transfer of resources from foreign oil suppliers to U.S. purchasers (or more properly, in a savings in the value of resources previously transferred from U.S. purchasers to foreign producers), and provides no real savings in resources to the global economy. Thus NHTSA’s analysis of the benefits from adopting higher CAFE standards for MY 2012-2016 cars and light trucks excludes the reduced value of monopsony payments by U.S. oil consumers that might result from lower fuel consumption by these vehicles, and they are likewise not included in the uncertainty analysis.

The second component of external economic costs imposed by U.S. petroleum imports arises partly because an increase in oil prices triggered by a disruption in the supply of imported oil reduces the level of output that the U.S. economy can produce. The reduction in potential U.S. economic output depends on the extent and duration of the increases in petroleum product prices that result from a disruption in the supply of imported oil, as well as on whether and how rapidly these prices return to pre-disruption levels. Even if prices for imported oil return completely to their original levels, however, economic output will be at least temporarily reduced from the level that would have been possible without a disruption in oil supplies. A more complete discussion of price shock is provided in Chapter V, where it is estimated that each gallon of fuel saved that results in a reduction in U.S. petroleum imports (either crude petroleum or refined fuel) will reduce the expected costs of oil supply disruptions to the U.S. economy by \$0.078 to \$0.269, with the actual value most likely to be \$0.169 per gallon. For the uncertainty analysis, this central value is used with a normal distribution and a standard deviation of \$0.06.

³¹⁴ The reduction in payments from U.S. oil purchasers to domestic petroleum producers is not included as a benefit, since it represents a transfer that occurs entirely within the U.S. economy.

A third imported oil externality is military security. In Chapter VIII, NHTSA thus concludes that the levels of U.S. military activity and expenditures are likely to remain unaffected by even relatively large changes in light duty vehicle fuel consumption. As a consequence, the agency's analysis of alternative CAFE standards for MY 2012-2016 does not include savings in budgetary outlays to support U.S. military activities among the benefits of higher fuel economy and the resulting fuel savings.

Nevertheless, the agency conducted a sensitivity analysis of the potential effect of assuming that some reduction in military spending would result from fuel savings and reduced petroleum imports in order to investigate its impacts on the standards and fuel savings. Assuming that the preceding estimate of total U.S. military costs for securing Persian Gulf oil supplies is correct, and that approximately half of these expenses could be reduced in proportion to a reduction in U.S. oil imports from the region, the estimated savings would range from \$0.02 to \$0.08 (in 2007 dollars) for each gallon of fuel savings that was reflected in lower U.S. imports of petroleum from the Persian Gulf. If the Persian Gulf region is assumed to be the marginal source of supply for U.S. imports of crude petroleum and refined products, then each gallon of fuel saved might reduce U.S. military outlays by \$0.05 per gallon, the midpoint of this range. NHTSA employs this estimate in its sensitivity analysis, and examines it further as part of this uncertainty analysis, assuming a 25% probability for this alternate impact.

Table XII-3 lists the range of values that were examined for oil consumption externalities. The expected values were used in the main analysis. Both the value of reducing U.S. demand on the world market price for oil and the value of reduced threat of supply disruptions were derived from a study by Leiby (2008) (see Chapter VIII). For reasons noted in Chapter VIII, military security is not specifically valued in this analysis. A normal distribution was assumed for the range of values for oil consumption externalities with the low and high values assumed to be two standard deviations from the mean, based on the Leiby estimates.

Greenhouse Gas Emissions

Emissions of carbon dioxide and other greenhouse gases (GHGs) occur throughout the process of producing and distributing transportation fuels, as well as from fuel combustion itself. By reducing the volume of fuel consumed by passenger cars and light trucks, higher CAFE standards will thus reduce GHG emissions generated by fuel use, as well as throughout the fuel supply cycle. Lowering these emissions is likely to slow the projected pace and reduce the ultimate extent of future changes in the global climate, thus reducing future economic damages that changes in the global climate are otherwise expected to cause. Further, by reducing the probability that climate changes with potentially catastrophic economic or environmental impacts will occur, lowering GHG emissions may also result in economic benefits that exceed the resulting reduction in the expected future economic costs caused by gradual changes in the earth's climatic systems. In Chapter VIII, a more complete discussion of greenhouse gas emissions is presented along with a variety of estimates. The central estimate used in the analysis is \$20 per metric ton. For this uncertainty analysis, we used \$20 as the mean value with and \$15 as one standard deviation. The model chosen was a normal distribution with 3 standard deviations as the range. Since this model would predict negative costs, the lower end of the range was curtailed at \$0.

The Rebound Effect

By reducing the amount of gasoline used and, thus, the cost of operating a vehicle, higher CAFE standards are expected to result in a slight increase in annual miles driven per vehicle. This “rebound effect” impacts net societal benefits because the increase in miles driven offsets a portion of the gasoline savings that results from more fuel-efficient vehicles. Although consumers derive some value from this extra driving, it also leads to increases in crash, congestion, noise, and pollution costs associated with driving. Most recent estimates of the magnitude of the rebound effect for light duty vehicles fall in the range of 10-20 percent (i.e., increasing vehicle use will offset 10-20 percent of the fuel savings resulting from an improvement in fuel economy), but studies also show that the rebound effect has been gradually decreasing over time. A more complete discussion of the rebound effect is included in Chapter VIII. The agency employed a rebound effect of 10 percent in the main analysis. For the uncertainty analysis, a range of 0 to 21 percent is used and employed in a slightly skewed Beta distribution which produced a mean of approximately 10.1 percent. The skewed distribution reflects the agency’s belief that the more credible studies that differ from the 10 percent value chosen for the main analysis fall below this value (i.e., are more negative) and differ by more substantial margins than the upper range of credible values. Table XII-3 Summarizes the economic parameters used in the uncertainty analysis.

**Table XII-3
Monte Carlo Specific Parameters**

Discount Rates (%)	0.03, 0.07
Fuel Path Randomization Parameters	
Low	25%
Reference	50%
High	25%
Rebound Effect Randomization Parameters	
Alpha Shape	6.00
Beta Shape	6.50
Scale	-0.21
Base	0.00
Carbon Dioxide Randomization Parameters	
Mean	\$ 20.00
Standard Deviation	\$ 15.00
Monopsony Randomization Parameters	
Mean	\$ -
Standard Deviation	\$ -
Price Shock Randomization Parameters	
Mean	\$ 0.17
Standard Deviation	\$ 0.06
Military Security Randomization Parameters	
Alternative Cost	\$ 0.05
Alternative Cost Probability	25%

Modeling Results – Trial Draws

Because of the complexity of the CAFE model, the computer time required to perform the uncertainty analysis was significant. The uncertainty analysis conducted a total of 40,000 trials (20,000 for each discount rate) Figures XII- 3 through XII-14 graphically illustrate the draw results for a sample of the 82 variables (39 technology effectiveness rates, 39 technology costs, the fuel price scenario, oil import externalities, the rebound effect, and CO2.) that were examined.

Figure XII-3
Monte Carlo Draw Profile, Passenger Car Costs

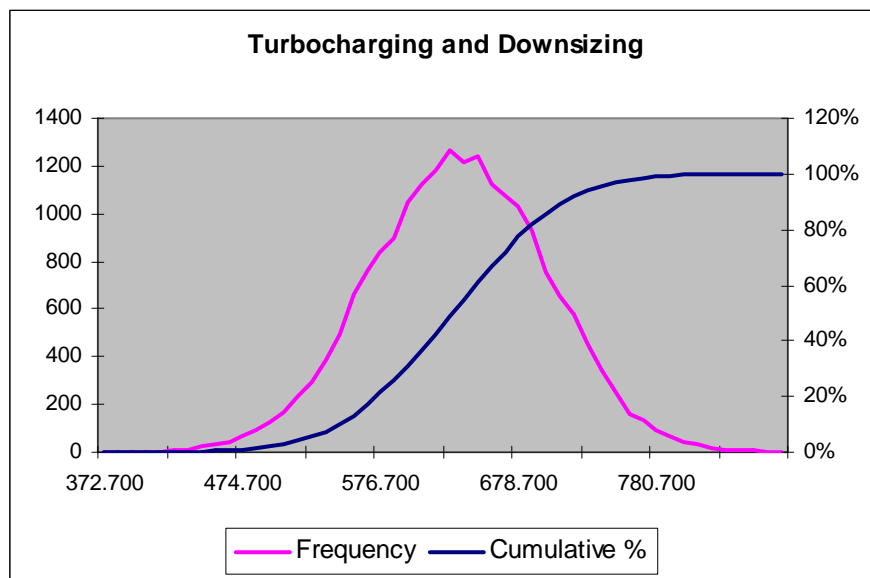

Figure XII-4
Monte Carlo Draw Profile, Passenger Car Effectiveness

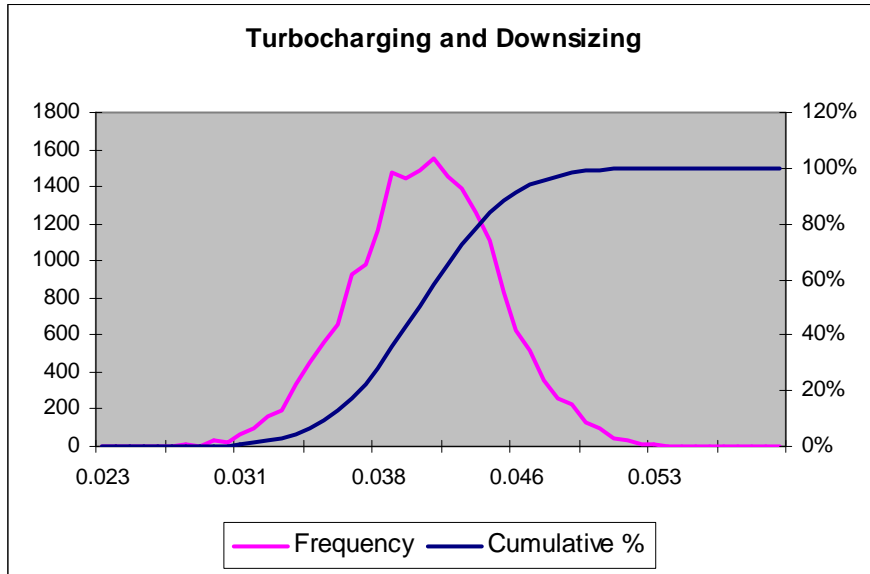

Figure XII-5
Monte Carlo Draw Profile, Passenger Cars, Costs

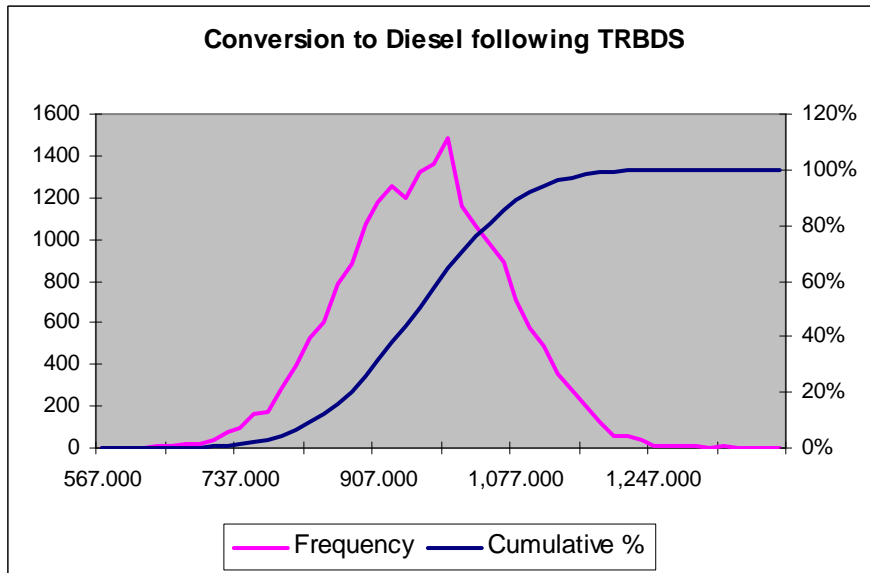

Figure XII-6
Monte Carlo Draw Profile, Passenger Cars, Effectiveness

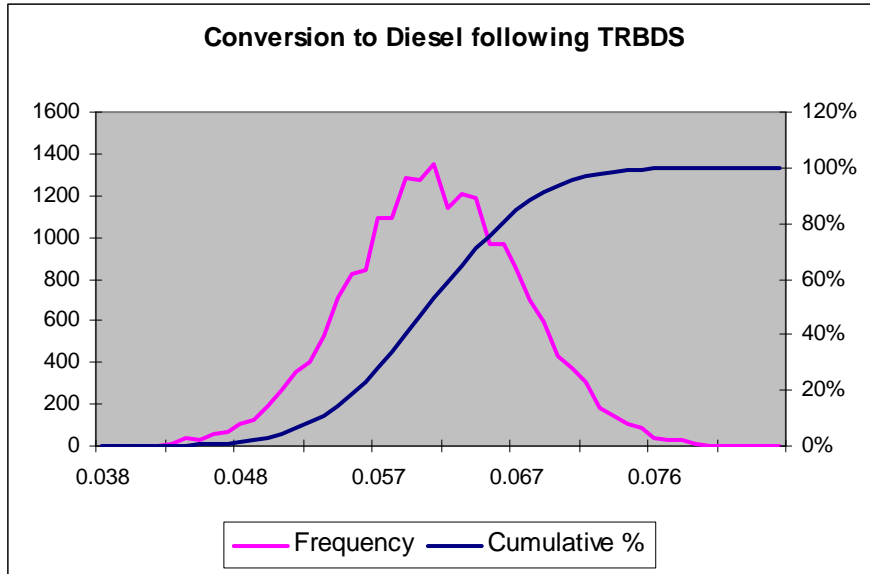
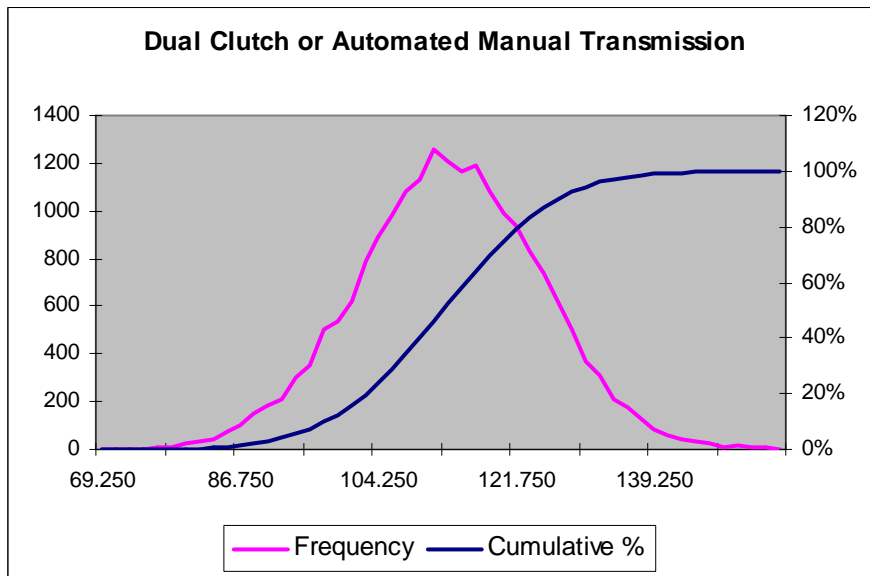
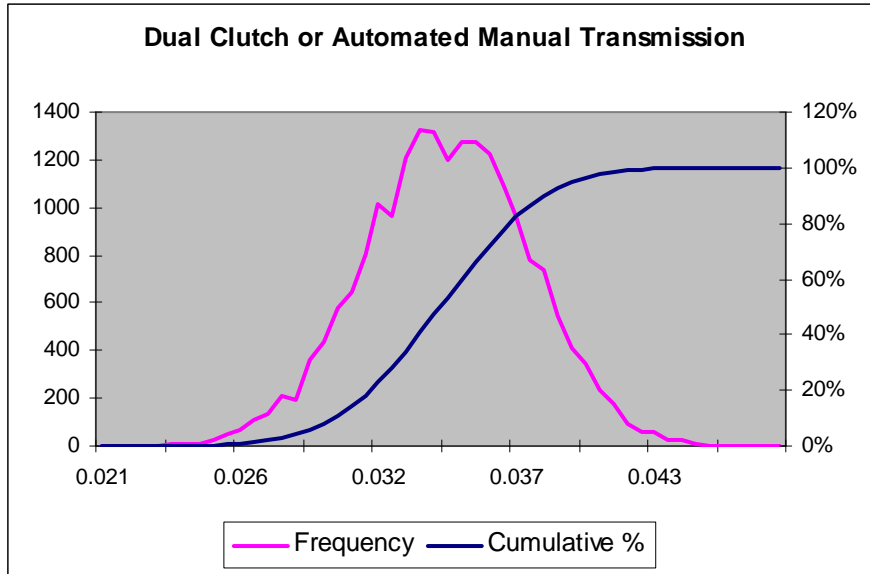

Figure XII-7
Monte Carlo Draw Profile, Passenger Cars, Costs



**Figure XII-8
Monte Carlo Draw Profile, Passenger Cars, Effectiveness**



**Figure XII-9
Monte Carlo Draw Profile
Pretax Fuel Price Path**

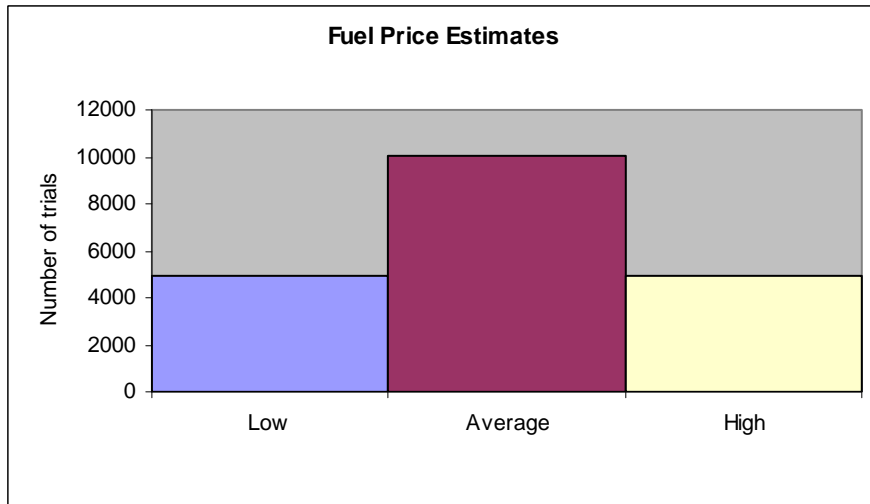

**Figure XII-10
Monte Carlo Draw Profile**

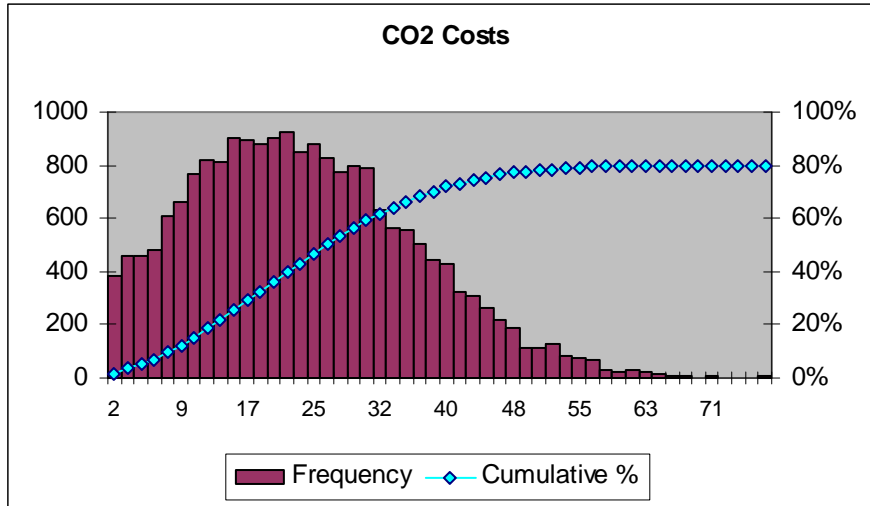

**Figure XII-11
Monte Carlo Draw Profile**

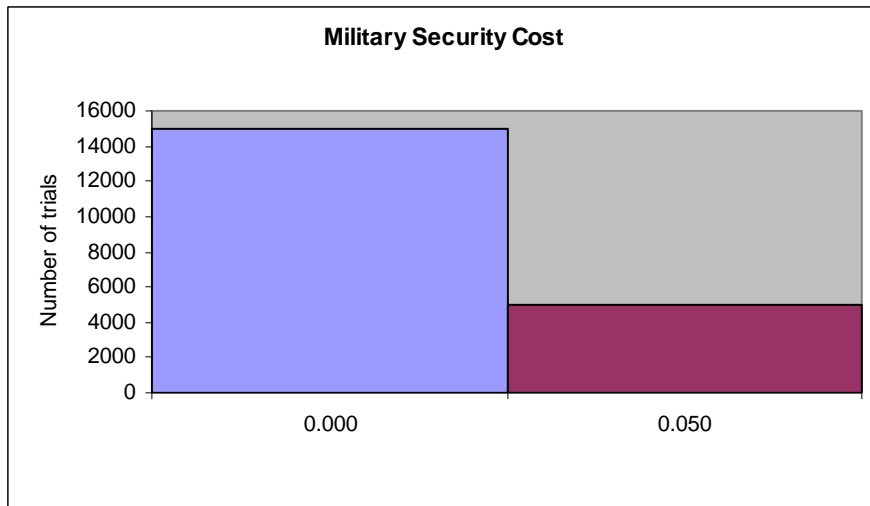

Figure XII-12
Monte Carlo Draw Profile

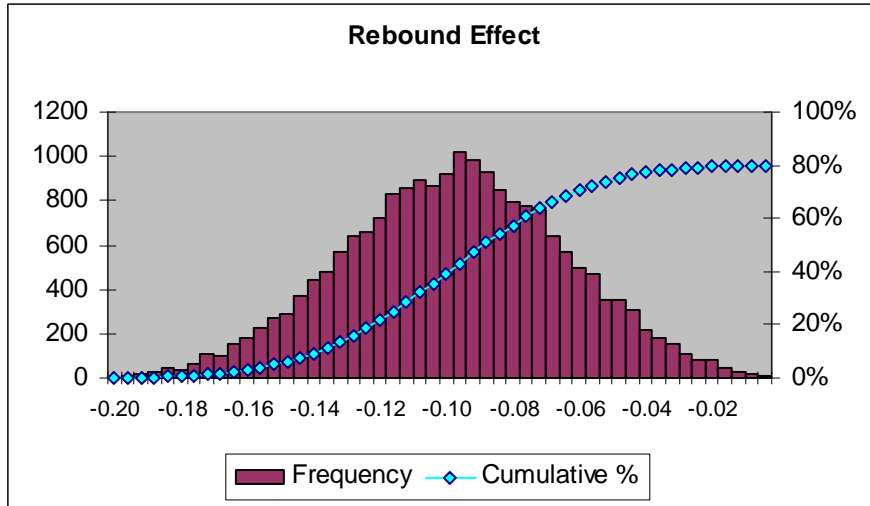

Figure XII-13
Monte Carlo Draw Profile

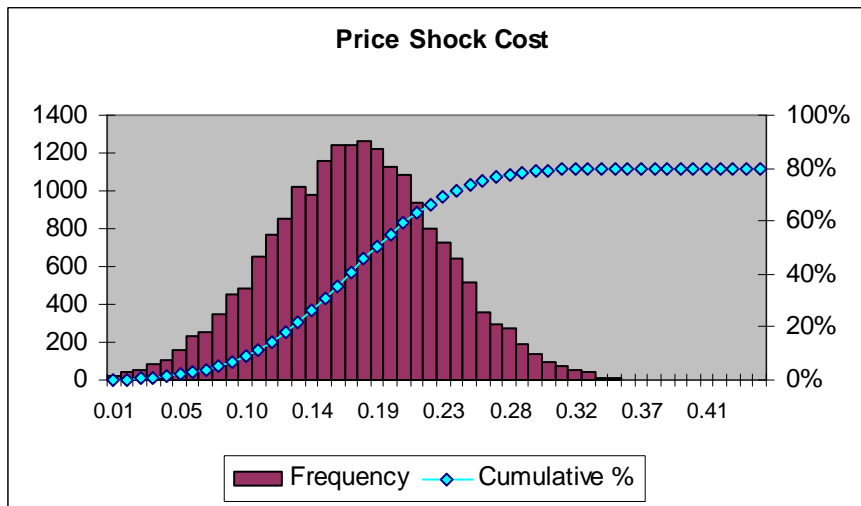

Table XII-3
Monte Carlo Draw Results, Economic Inputs

Economic Inputs	Minimum	Maximum	Mean	StdDev
Rebound Effect	-0.2067	-0.0043	-0.1011	0.0336
Military Security Cost	0	0.0500	0.0126	0.0217
Price Shock Cost	0.00032	0.4298	0.1699	0.0580
CO2 Cost	0.0069	76.712	22.702	12.731

Table XII-4
Monte Carlo Draw Results, Passenger Car Technology Costs

Technology	Minimum	Maximum	Mean	StdDev
Low Friction Lubricants	\$2.75	\$4.07	\$3.43	\$0.18
Engine Friction Reduction	\$9.99	\$15.59	\$12.58	\$0.65
VVT - Coupled Cam Phasing (CCP) on SOHC	\$36.55	\$55.49	\$45.10	\$2.32
Discrete Variable Valve Lift (DVVL) on SOHC	\$106.58	\$162.37	\$135.26	\$7.00
Cylinder Deactivation on SOHC	\$21.90	\$33.20	\$27.76	\$1.43
VVT - Intake Cam Phasing (ICP)	\$35.57	\$54.04	\$45.11	\$2.34
VVT - Dual Cam Phasing (DCP)	\$31.25	\$46.34	\$38.22	\$1.97
Discrete Variable Valve Lift (DVVL) on DOHC	\$109.32	\$161.18	\$135.43	\$7.03
Continuously Variable Valve Lift (CVVL)	\$103.68	\$415.33	\$273.93	\$42.44
Cylinder Deactivation on DOHC	\$22.47	\$34.44	\$27.75	\$1.45
Cylinder Deactivation on OHV	\$22.77	\$34.41	\$28.02	\$1.46
VVT - Coupled Cam Phasing (CCP) on OHV	\$32.79	\$50.91	\$41.09	\$2.13
Discrete Variable Valve Lift (DVVL) on OHV	\$94.10	\$141.35	\$119.19	\$6.08
Conversion to DOHC with DCP	\$220.74	\$320.00	\$266.59	\$13.74
Stoichiometric Gasoline Direct Injection (GDI)	\$49.18	\$71.80	\$60.99	\$3.16
Combustion Restart	\$71.76	\$164.20	\$117.54	\$12.20
Turbocharging and Downsizing	\$364.79	\$870.93	\$629.43	\$65.02
Exhaust Gas Recirculation (EGR) Boost	\$87.61	\$215.14	\$144.30	\$14.81
Conversion to Diesel following CBRST	\$955.30	\$2,308.42	\$1,662.70	\$171.26
Conversion to Diesel following TRBDS	\$569.24	\$1,397.62	\$955.32	\$99.45
6-Speed Manual/Improved Internals	\$201.88	\$311.40	\$249.94	\$12.96
Improved Auto. Trans. Controls/Externals	\$48.55	\$71.74	\$60.10	\$3.10
Continuously Variable Transmission	\$144.26	\$367.13	\$250.12	\$26.04
6/7/8-Speed Auto. Trans with Improved Internals	\$144.59	\$217.94	\$177.34	\$9.12

Dual Clutch or Automated Manual Transmission	\$69.70	\$152.86	\$112.33	\$11.55
Electric Power Steering	\$87.81	\$126.50	\$106.56	\$5.50
Improved Accessories	\$75.58	\$193.10	\$128.08	\$13.22
12V Micro-Hybrid	\$208.34	\$454.22	\$326.66	\$34.03
Belt mounted Integrated Starter Generator	\$165.43	\$406.59	\$285.21	\$29.32
Crank mounted Integrated Starter Generator	\$1,331.85	\$4,799.58	\$3,161.68	\$485.02
Power Split Hybrid	\$1,064.66	\$4,444.78	\$2,583.91	\$402.19
2-Mode Hybrid	\$1,522.98	\$6,186.95	\$3,917.36	\$602.71
Plug-in Hybrid	\$6,191.35	\$24,405.94	\$14,449.99	\$2,224.72
Material Substitution (1.50%)	\$1.16	\$1.76	\$1.48	\$0.08
Material Substitution (5% to 10% Cum)	\$1.17	\$1.75	\$1.48	\$0.08
Low Rolling Resistance Tires	\$4.59	\$6.82	\$5.72	\$0.30
Low Drag Brakes	\$49.52	\$74.52	\$62.86	\$3.26
Secondary Axle Disconnect - Ladder Frame	\$68.48	\$109.05	\$86.93	\$4.54
Aero Drag Reduction	\$37.60	\$59.12	\$47.59	\$2.47

**Table XII-5
Monte Carlo Draw Results, Passenger Car Fuel Economy Improvement Rates**

Technology	Minimum	Maximum	Mean	StdDev
Low Friction Lubricants	0.003119	0.007203	0.004996	0.000485
Engine Friction Reduction	0.00843	0.022557	0.015005	0.001677
VVT - Coupled Cam Phasing (CCP) on SOHC	0.006861	0.032619	0.019951	0.003335
Discrete Variable Valve Lift (DVVL) on SOHC	0.006808	0.035807	0.020027	0.003294
Cylinder Deactivation on SOHC	0.024074	0.030472	0.0275	0.00083
VVT - Intake Cam Phasing (ICP)	0.008705	0.021938	0.015011	0.001688
VVT - Dual Cam Phasing (DCP)	0.018237	0.031544	0.025009	0.001676
Discrete Variable Valve Lift (DVVL) on DOHC	0.006566	0.032032	0.020002	0.00331
Continuously Variable Valve Lift (CVVL)	0.011294	0.040477	0.025009	0.003319
Cylinder Deactivation on DOHC	0.000004	0.00553	0.002493	0.000828
Cylinder Deactivation on OHV	0.036443	0.056757	0.046983	0.002674
VVT - Coupled Cam Phasing (CCP) on OHV	0.009179	0.015658	0.012505	0.000838
Discrete Variable Valve Lift (DVVL) on OHV	0.003282	0.026968	0.014998	0.003333
Conversion to DOHC with DCP	0.007267	0.026281	0.017529	0.002505

Stoichiometric Gasoline Direct Injection (GDI)	0.018628	0.032281	0.024993	0.001665
Combustion Restart	0.014263	0.033493	0.022514	0.00218
Turbocharging and Downsizing	0.024397	0.057949	0.040425	0.003918
Exhaust Gas Recirculation (EGR) Boost	0.024842	0.054176	0.037512	0.003624
Conversion to Diesel following CBRST	0.069961	0.15354	0.112405	0.010687
Conversion to Diesel following TRBDS	0.037976	0.083926	0.060852	0.00589
6-Speed Manual/Improved Internals	0.003087	0.006689	0.005005	0.000484
Improved Auto. Trans. Controls/Externals	0.013493	0.026382	0.019987	0.001682
Continuously Variable Transmission	0.004768	0.023397	0.013507	0.002158
6/7/8-Speed Auto. Trans with Improved Internals	0.012208	0.036136	0.024049	0.003346
Dual Clutch or Automated Manual Transmission	0.020488	0.046634	0.033974	0.003277
Electric Power Steering	0.009178	0.021118	0.015019	0.001645
Improved Accessories	0.00822	0.021751	0.014987	0.001689
12V Micro-Hybrid	0.016332	0.035641	0.025954	0.002485
Belt mounted Integrated Starter Generator	0.032692	0.070807	0.049038	0.004776
Crank mounted Integrated Starter Generator	0.053072	0.119779	0.087826	0.008393
Power Split Hybrid	0.053482	0.129763	0.093042	0.010149
2-Mode Hybrid	0.023193	0.078126	0.051396	0.007147
Plug-in Hybrid	0.288526	0.63787	0.464333	0.045022
Material Substitution (1.50%)	0.005873	0.013347	0.009743	0.000953
Material Substitution (5% to 10% Cum)	0.019885	0.044104	0.033004	0.003204
Low Rolling Resistance Tires	0.009215	0.021414	0.015018	0.001649
Low Drag Brakes	0.004314	0.010615	0.007509	0.000827
Secondary Axle Disconnect - Ladder Frame	0.009304	0.015568	0.012503	0.000837
Aero Drag Reduction	0.018926	0.031435	0.025019	0.001661

**Table XII-6
Monte Carlo Draw Results, Light Truck Technology Costs**

Technology	Minimum	Maximum	Mean	StdDev
Low Friction Lubricants	\$2.75	\$4.07	\$3.43	\$0.18
Engine Friction Reduction	\$9.99	\$15.59	\$12.58	\$0.65
VVT - Coupled Cam Phasing (CCP) on SOHC	\$36.55	\$55.49	\$45.10	\$2.32
Discrete Variable Valve Lift (DVVL) on SOHC	\$99.40	\$151.43	\$126.15	\$6.53
Cylinder Deactivation on SOHC	\$21.90	\$33.20	\$27.76	\$1.43
VVT - Intake Cam Phasing (ICP)	\$35.57	\$54.04	\$45.11	\$2.34

VVT - Dual Cam Phasing (DCP)	\$33.26	\$49.31	\$40.67	\$2.09
Discrete Variable Valve Lift (DVVL) on DOHC	\$101.96	\$150.32	\$126.31	\$6.56
Continuously Variable Valve Lift (CVVL)	\$101.42	\$406.29	\$267.97	\$41.52
Cylinder Deactivation on DOHC	\$22.47	\$34.44	\$27.75	\$1.45
Cylinder Deactivation on OHV	\$21.34	\$32.25	\$26.27	\$1.36
VVT - Coupled Cam Phasing (CCP) on OHV	\$21.05	\$32.67	\$26.37	\$1.37
Discrete Variable Valve Lift (DVVL) on OHV	\$28.17	\$42.31	\$35.68	\$1.82
Conversion to DOHC with DCP	\$207.15	\$300.30	\$250.17	\$12.89
Stoichiometric Gasoline Direct Injection (GDI)	\$41.75	\$60.96	\$51.78	\$2.68
Combustion Restart	\$71.76	\$164.20	\$117.54	\$12.20
Turbocharging and Downsizing	\$440.80	\$1,052.41	\$760.59	\$78.57
Exhaust Gas Recirculation (EGR) Boost	\$87.61	\$215.14	\$144.30	\$14.81
Conversion to Diesel following CBRST	\$1,122.13	\$2,711.54	\$1,953.06	\$201.17
Conversion to Diesel following TRBDS	\$608.78	\$1,494.70	\$1,021.68	\$106.36
6-Speed Manual/Improved Internals	\$201.88	\$311.40	\$249.94	\$12.96
Improved Auto. Trans. Controls/Externals	\$48.55	\$71.74	\$60.10	\$3.10
Continuously Variable Transmission	\$144.26	\$367.13	\$250.12	\$26.04
6/7/8-Speed Auto. Trans with Improved Internals	\$168.52	\$254.00	\$206.68	\$10.62
Dual Clutch or Automated Manual Transmission	\$88.95	\$195.07	\$143.34	\$14.73
Electric Power Steering	\$87.81	\$126.50	\$106.56	\$5.50
Improved Accessories	\$75.58	\$193.10	\$128.08	\$13.22
12V Micro-Hybrid	\$229.81	\$501.02	\$360.32	\$37.54
Belt mounted Integrated Starter Generator	\$165.43	\$406.59	\$285.21	\$29.32
Crank mounted Integrated Starter Generator	\$1,730.59	\$6,236.51	\$4,108.24	\$630.23
Power Split Hybrid	\$1,285.21	\$5,365.53	\$3,119.18	\$485.50
2-Mode Hybrid	\$1,920.03	\$7,799.94	\$4,938.65	\$759.85
Plug-in Hybrid	\$6,956.54	\$27,422.28	\$16,235.87	\$2,499.67
Material Substitution (1.50%)	\$1.16	\$1.76	\$1.48	\$0.08
Material Substitution (5% to 10% Cum)	\$1.17	\$1.75	\$1.48	\$0.08
Low Rolling Resistance Tires	\$4.59	\$6.82	\$5.72	\$0.30
Low Drag Brakes	\$49.52	\$74.52	\$62.86	\$3.26
Secondary Axle Disconnect - Ladder	\$68.48	\$109.05	\$86.93	\$4.54

Frame				
Aero Drag Reduction	\$37.60	\$59.12	\$47.59	\$2.47

Table XII-7
Monte Carlo Draw Results, Light Truck Fuel Economy Improvement Rates

Technology	Minimum	Maximum	Mean	StdDev
Low Friction Lubricants	0.003119	0.007203	0.004996	0.000485
Engine Friction Reduction	0.00843	0.022557	0.015005	0.001677
VVT - Coupled Cam Phasing (CCP) on SOHC	0.006861	0.032619	0.019951	0.003335
Discrete Variable Valve Lift (DVVL) on SOHC	0.006808	0.035807	0.020027	0.003294
Cylinder Deactivation on SOHC	0.024074	0.030472	0.0275	0.00083
VVT - Intake Cam Phasing (ICP)	0.008705	0.021938	0.015011	0.001688
VVT - Dual Cam Phasing (DCP)	0.018237	0.031544	0.025009	0.001676
Discrete Variable Valve Lift (DVVL) on DOHC	0.006566	0.032032	0.020002	0.00331
Continuously Variable Valve Lift (CVVL)	0.011294	0.040477	0.025009	0.003319
Cylinder Deactivation on DOHC	0.000004	0.00553	0.002493	0.000828
Cylinder Deactivation on OHV	0.036443	0.056757	0.046983	0.002674
VVT - Coupled Cam Phasing (CCP) on OHV	0.009179	0.015658	0.012505	0.000838
Discrete Variable Valve Lift (DVVL) on OHV	0.003282	0.026968	0.014998	0.003333
Conversion to DOHC with DCP	0.007267	0.026281	0.017529	0.002505
Stoichiometric Gasoline Direct Injection (GDI)	0.018628	0.032281	0.024993	0.001665
Combustion Restart	0.014263	0.033493	0.022514	0.00218
Turbocharging and Downsizing	0.013749	0.032657	0.022781	0.002208
Exhaust Gas Recirculation (EGR) Boost	0.024842	0.054176	0.037512	0.003624
Conversion to Diesel following CBRST	0.069961	0.15354	0.112405	0.010687
Conversion to Diesel following TRBDS	0.037976	0.083926	0.060852	0.00589
6-Speed Manual/Improved Internals	0.003087	0.006689	0.005005	0.000484
Improved Auto. Trans. Controls/Externals	0.013493	0.026382	0.019987	0.001682
Continuously Variable Transmission	0.004768	0.023397	0.013507	0.002158

6/7/8-Speed Auto. Trans with Improved Internals	0.012208	0.036136	0.024049	0.003346
Dual Clutch or Automated Manual Transmission	0.020488	0.046634	0.033974	0.003277
Electric Power Steering	0.009178	0.021118	0.015019	0.001645
Improved Accessories	0.00822	0.021751	0.014987	0.001689
12V Micro-Hybrid	0.018006	0.039294	0.028615	0.00274
Belt mounted Integrated Starter Generator	0.030919	0.066967	0.046378	0.004517
Crank mounted Integrated Starter Generator	0.068152	0.153814	0.112781	0.010778
Power Split Hybrid	0.053482	0.129763	0.093042	0.010149
2-Mode Hybrid	0.026544	0.089415	0.058822	0.00818
Plug-in Hybrid	0.288526	0.63787	0.464333	0.045022
Material Substitution (1.50%)	0.005873	0.013347	0.009743	0.000953
Material Substitution (5% to 10% Cum)	0.027571	0.061152	0.045762	0.004443
Low Rolling Resistance Tires	0.009215	0.021414	0.015018	0.001649
Low Drag Brakes	0.004314	0.010615	0.007509	0.000827
Secondary Axle Disconnect - Ladder Frame	0.009304	0.015568	0.012503	0.000837
Aero Drag Reduction	0.018926	0.031435	0.025019	0.001661

Modeling Results – Output

Tables XII-8 and XII-9 summarize the modeling results for fuel saved, total costs, societal benefits, and net benefits for passenger cars and trucks respectively under a 7% discount rate. They also indicate the probability that net benefits exceed zero. Tables XII-10 and XII-11 summarize these same results under a 3% discount rate. These results are also illustrated in Figures XII-14 through XII-17 for passenger cars under Optimized CAFE at 7 percent for MY 2016. Although not shown here, the general shape of the resulting output distributions are similar for the light trucks, the 3 percent discount rate, and for other model years as well. The humped shape that occurs for both social benefits and net benefits reflects the three different gasoline price scenarios. About half of all draws were selected from the AEO Reference Case, while about one quarter were drawn from the Low Oil Price scenario and one quarter were drawn from the High Oil Price scenario. This produces three separate humps which reflect the increasing impact on benefits from the three progressively higher oil price scenarios. The following discussions summarize the range of results presented in these tables for the combined passenger car and light truck across both the 7 percent (typically the lower range) and 3 percent (typically upper range) discount rates³¹⁵.

³¹⁵ In a few cases the upper range results were obtained from the 7% rate and the lower range results were obtained from the 3% rate. While this may seem counterintuitive, it results from the random selection process that is inherent in the Monte Carlo technique.

Fuel Savings: The analysis indicates that MY 2012 vehicles (both passenger cars and light trucks) will experience between 3,137,969 million and 5,102,848 million gallons of fuel savings over their useful lifespan. MY 2013 vehicles will experience between 7,518,581 million and 10,729,654 million gallons of fuel savings over their useful lifespan. MY 2014 vehicles will experience between 11,153,391 million and 14,977,247 million gallons of fuel savings over their useful lifespan. MY 2015 vehicles will experience between 14,084,391 and 18,390,373 million gallons of fuel savings over their useful lifespan. MY 2016 vehicles will experience between 17,352,371 and 21,640,762 million gallons of fuel savings over their useful lifespan. Over the combined lifespan of the five model years, between 53.3 trillion and 70.7 trillion gallons of fuel will be saved.

Total Costs: The analysis indicates that owners of MY 2012 passenger cars and light trucks will pay between \$3,879 million and \$7,272 million in higher vehicle prices to purchase vehicles with improved fuel efficiency. MY 2013 owners will pay between \$7,210 million and \$11,270 million more. MY 2014 owners will pay between \$10,114 million and \$15,205 million more. MY 2015 owners will pay between \$12,497 million and \$18,236 million more. MY 2016 owners will pay between \$14,644 million and \$20,824 million more. Owners of all five model years vehicles combined will pay between \$48.4 billion and \$72.8 billion in higher vehicle prices to purchase vehicles with improved fuel efficiency.

Societal Benefits: The analysis indicates that changes to MY 2012 passenger cars and light trucks to meet the proposed CAFE standards will produce overall societal benefits valued between \$4,533 million and \$22,278 million. MY 2013 vehicles will produce benefits valued between \$10,253 million and \$47,939 million. MY 2014 vehicles will produce benefits valued between \$14,962 million and \$69,625 million. MY 2015 vehicles will produce benefits valued between \$18,734 million and \$88,910 million. MY 2016 vehicles will produce benefits valued between \$22,984 million and \$106,121 million. Over the combined lifespan of the five model years, societal benefits valued between \$71.5 billion and \$334.9 billion will be produced.

Net Benefits: The uncertainty analysis indicates that the net impact of the higher CAFE requirements for MY 2012 passenger cars and light trucks will be between a net cost of \$2,471 million and a net benefit of \$18,351 million. There is at least an 85 percent certainty that changes made to MY 2012 vehicles to achieve the higher CAFE standards will produce a net benefit. The net impact of the higher CAFE requirements for MY 2013 will be a net benefit of between \$855 million and a net benefit of \$44,318 million. There is a 100 percent certainty that changes made to MY 2013 vehicles to achieve the CAFE standards will produce a net benefit. The net impact of the higher CAFE requirements for MY 2014 will be a net benefit of between \$2,861 million and a net benefit of \$65,016 million. There is a 100 percent certainty that changes made to MY 2014 vehicles to achieve the higher CAFE standards will produce a net benefit. The net impact of the higher CAFE requirements for MY 2015 will be a net benefit of between \$4,872 million and \$83,794 million. There is 100 percent certainty that changes made to MY 2015 vehicles to achieve the CAFE standards will produce a net benefit. The net impact of the higher CAFE requirements for MY 2016 will be a net benefit of between \$7,304 million and \$103,583 million. There is 100 percent certainty that changes made to MY 2016 vehicles to achieve the CAFE standards will produce a net benefit. Over all five model years, the higher CAFE standards will produce net benefits ranging from \$13.4 billion to \$315.1 billion. There is

at least an 85 percent certainty that higher CAFE standards will produce a net societal benefit in each of the model years covered by this final rule. In most years, this probability is 100%.

Table XII-8
UNCERTAINTY ANALYSIS RESULTS, PASSENGER CARS
 (7% Discount Rate)

Item	Mean	Low	High
MY 2012			
Fuel Saved (mill. gall.)	2,349,486	1,826,155	2,825,372
Total Cost (\$mill.)	\$4,032	\$2,813	\$5,077
Societal Benefits (\$mill.)	\$5,849	\$2,617	\$9,968
Net Benefits (\$mill.)	\$1,817	-\$1,585	\$6,492
% Certainty Net Ben. > 0	85%		
MY 2013			
Fuel Saved (mill. gall.)	5,313,209	4,576,602	6,157,558
Total Cost (\$mill.)	\$6,442	\$5,227	\$7,614
Societal Benefits (\$mill.)	\$13,684	\$6,218	\$22,237
Net Benefits (\$mill.)	\$7,242	-\$305	\$16,365
% Certainty Net Ben. > 0	100%		
MY 2014			
Fuel Saved (mill. gall.)	7,455,772	6,561,442	8,452,773
Total Cost (\$mill.)	\$8,302	\$6,947	\$9,649
Societal Benefits (\$mill.)	\$19,684	\$8,852	\$32,040
Net Benefits (\$mill.)	\$11,382	\$415	\$24,411
% Certainty Net Ben. > 0	100%		
MY 2015			
Fuel Saved (mill. gall.)	9,272,921	8,126,852	10,478,561
Total Cost (\$mill.)	\$9,757	\$8,273	\$11,212
Societal Benefits (\$mill.)	\$25,025	\$10,996	\$40,996
Net Benefits (\$mill.)	\$15,267	\$1,125	\$31,793
% Certainty Net Ben. > 0	100%		
MY 2016			
Fuel Saved (mill. gall.)	11,466,336	10,341,428	12,686,543
Total Cost (\$mill.)	\$11,597	\$9,778	\$13,342
Societal Benefits (\$mill.)	\$31,474	\$13,820	\$50,310
Net Benefits (\$mill.)	\$19,877	\$2,001	\$39,532
% Certainty Net Ben. > 0	100%		

Table XII-9
UNCERTAINTY ANALYSIS RESULTS, LIGHT TRUCKS
 (7% Discount Rate)

Item	Mean	Low	High
MY 2012			
Fuel Saved (mill. gall.)	1,699,303	1,364,351	2,163,492
Total Cost (\$mill.)	\$1,532	\$1,067	\$1,979
Societal Benefits (\$mill.)	\$4,099	\$1,915	\$7,184
Net Benefits (\$mill.)	\$3,445	-\$887	\$9,175
% Certainty Net Ben. > 0	98%		
MY 2013			
Fuel Saved (mill. gall.)	3,593,670	2,972,514	4,444,018
Total Cost (\$mill.)	\$2,720	\$1,983	\$3,473
Societal Benefits (\$mill.)	\$8,884	\$4,035	\$15,036
Net Benefits (\$mill.)	\$10,790	\$1,160	\$22,159
% Certainty Net Ben. > 0	100%		
MY 2014			
Fuel Saved (mill. gall.)	5,415,390	4,672,639	6,407,244
Total Cost (\$mill.)	\$4,155	\$3,167	\$5,403
Societal Benefits (\$mill.)	\$13,692	\$6,111	\$22,708
Net Benefits (\$mill.)	\$16,397	\$2,447	\$32,508
% Certainty Net Ben. > 0	100%		
MY 2015			
Fuel Saved (mill. gall.)	6,823,331	5,957,540	7,890,981
Total Cost (\$mill.)	\$5,282	\$4,224	\$6,638
Societal Benefits (\$mill.)	\$17,607	\$7,738	\$29,029
Net Benefits (\$mill.)	\$21,534	\$3,747	\$41,897
% Certainty Net Ben. > 0	100%		
MY 2016			
Fuel Saved (mill. gall.)	7,889,479	7,010,950	8,954,219
Total Cost (\$mill.)	\$6,058	\$4,910	\$7,449
Societal Benefits (\$mill.)	\$20,691	\$9,165	\$32,781
Net Benefits (\$mill.)	\$27,565	\$5,303	\$51,791
% Certainty Net Ben. > 0	100%		

Table XII-10
UNCERTAINTY ANALYSIS RESULTS, PASSENGER CARS AND LIGHT TRUCKS
 (7% Discount Rate)

Item	Mean	Low	High
MY 2012			
Fuel Saved (mill. gall.)	4,048,789	3,190,506	4,988,864
Total Cost (\$mill.)	\$5,564	\$3,879	\$7,056
Societal Benefits (\$mill.)	\$9,948	\$4,533	\$17,152
Net Benefits (\$mill.)	\$5,261	-\$2,471	\$15,668
% Certainty Net Ben. > 0			
MY 2013			
Fuel Saved (mill. gall.)	8,906,879	7,549,116	10,601,576
Total Cost (\$mill.)	\$9,162	\$7,210	\$11,087
Societal Benefits (\$mill.)	\$22,568	\$10,253	\$37,273
Net Benefits (\$mill.)	\$18,033	\$855	\$38,524
% Certainty Net Ben. > 0			
MY 2014			
Fuel Saved (mill. gall.)	12,871,163	11,234,081	14,860,018
Total Cost (\$mill.)	\$12,457	\$10,114	\$15,051
Societal Benefits (\$mill.)	\$33,376	\$14,962	\$54,749
Net Benefits (\$mill.)	\$27,779	\$2,861	\$56,919
% Certainty Net Ben. > 0			
MY 2015			
Fuel Saved (mill. gall.)	16,096,251	14,084,391	18,369,543
Total Cost (\$mill.)	\$15,040	\$12,497	\$17,850
Societal Benefits (\$mill.)	\$42,632	\$18,734	\$70,024
Net Benefits (\$mill.)	\$36,801	\$4,872	\$73,690
% Certainty Net Ben. > 0			
MY 2016			
Fuel Saved (mill. gall.)	19,355,815	17,352,379	21,640,762
Total Cost (\$mill.)	\$17,655	\$14,689	\$20,790
Societal Benefits (\$mill.)	\$52,165	\$22,984	\$83,091
Net Benefits (\$mill.)	\$47,442	\$7,304	\$91,324
% Certainty Net Ben. > 0			

Table XII-11
UNCERTAINTY ANALYSIS RESULTS, PASSENGER CARS
 (3% Discount Rate)

Item	Mean	Low	High
MY 2012			
Fuel Saved (mill. gall.)	2,384,828	1,773,747	2,869,017
Total Cost (\$mill.)	4,060	2,857	5,229
Societal Benefits (\$mill.)	7,505	3,258	12,760
Net Benefits (\$mill.)	3,445	-887	9,175
% Certainty Net Ben. > 0	98%		
MY 2013			
Fuel Saved (mill. gall.)	5,352,668	4,510,860	6,230,620
Total Cost (\$mill.)	6,491	5,273	7,772
Societal Benefits (\$mill.)	17,281	7,609	28,178
Net Benefits (\$mill.)	10,790	1,160	22,159
% Certainty Net Ben. > 0	100%		
MY 2014			
Fuel Saved (mill. gall.)	7,511,081	6,508,350	8,506,467
Total Cost (\$mill.)	8,388	6,950	10,022
Societal Benefits (\$mill.)	24,785	10,796	40,337
Net Benefits (\$mill.)	16,397	2,447	32,508
% Certainty Net Ben. > 0	100%		
MY 2015			
Fuel Saved (mill. gall.)	9,336,733	8,151,069	10,475,813
Total Cost (\$mill.)	9,873	8,188	11,700
Societal Benefits (\$mill.)	31,407	13,532	51,273
Net Benefits (\$mill.)	21,534	3,747	41,897
% Certainty Net Ben. > 0	100%		
MY 2016			
Fuel Saved (mill. gall.)	11,507,055	10,353,939	12,683,142
Total Cost (\$mill.)	11,725	9,637	13,437
Societal Benefits (\$mill.)	39,290	17,127	63,134
Net Benefits (\$mill.)	27,565	5,303	51,791
% Certainty Net Ben. > 0	100%		

Table XII-12
UNCERTAINTY ANALYSIS RESULTS, LIGHT TRUCKS
 (3% Discount Rate)

Item	Mean	Low	High
MY 2012			
Fuel Saved (mill. gall.)	1,729,746	1,364,222	2,233,831
Total Cost (\$mill.)	1,571	1,138	2,043
Societal Benefits (\$mill.)	5,372	2,421	9,519
Net Benefits (\$mill.)	3,445	-887	9,175
% Certainty Net Ben. > 0	98%		
MY 2013			
Fuel Saved (mill. gall.)	3,632,143	3,007,722	4,499,034
Total Cost (\$mill.)	2,773	2,054	3,498
Societal Benefits (\$mill.)	11,515	5,091	19,762
Net Benefits (\$mill.)	10,790	1,160	22,159
% Certainty Net Ben. > 0	100%		
MY 2014			
Fuel Saved (mill. gall.)	5,463,852	4,645,041	6,470,780
Total Cost (\$mill.)	4,234	3,238	5,183
Societal Benefits (\$mill.)	17,669	7,707	29,288
Net Benefits (\$mill.)	16,397	2,447	32,508
% Certainty Net Ben. > 0	100%		
MY 2015			
Fuel Saved (mill. gall.)	6,869,254	5,992,405	7,914,560
Total Cost (\$mill.)	5,369	4,311	6,536
Societal Benefits (\$mill.)	22,621	9,752	37,636
Net Benefits (\$mill.)	21,534	3,747	41,897
% Certainty Net Ben. > 0	100%		
MY 2016			
Fuel Saved (mill. gall.)	7,911,369	7,035,562	8,782,459
Total Cost (\$mill.)	6,122	5,008	7,387
Societal Benefits (\$mill.)	26,446	11,557	42,987
Net Benefits (\$mill.)	27,565	5,303	51,791
% Certainty Net Ben. > 0	100%		

Table XII-13
UNCERTAINTY ANALYSIS RESULTS, PASSENGER CARS AND LIGHT TRUCKS
 (3% Discount Rate)

Item	Mean	Low	High
MY 2012			
Fuel Saved (mill. gall.)	4,114,574	3,137,969	5,102,848
Total Cost (\$mill.)	\$5,631	\$3,995	\$7,272
Societal Benefits (\$mill.)	\$12,877	\$5,679	\$22,278
Net Benefits (\$mill.)	\$6,889	-\$1,773	\$18,351
% Certainty Net Ben. > 0			
MY 2013			
Fuel Saved (mill. gall.)	8,984,811	7,518,581	10,729,654
Total Cost (\$mill.)	\$9,264	\$7,328	\$11,270
Societal Benefits (\$mill.)	\$28,797	\$12,700	\$47,939
Net Benefits (\$mill.)	\$21,581	\$2,319	\$44,318
% Certainty Net Ben. > 0			
MY 2014			
Fuel Saved (mill. gall.)	12,974,933	11,153,391	14,977,247
Total Cost (\$mill.)	\$12,622	\$10,188	\$15,205
Societal Benefits (\$mill.)	\$42,454	\$18,504	\$69,625
Net Benefits (\$mill.)	\$32,794	\$4,893	\$65,016
% Certainty Net Ben. > 0			
MY 2015			
Fuel Saved (mill. gall.)	16,205,988	14,143,474	18,390,373
Total Cost (\$mill.)	\$15,242	\$12,499	\$18,236
Societal Benefits (\$mill.)	\$54,028	\$23,285	\$88,910
Net Benefits (\$mill.)	\$43,068	\$7,494	\$83,794
% Certainty Net Ben. > 0			
MY 2016			
Fuel Saved (mill. gall.)	19,418,424	17,389,501	21,465,601
Total Cost (\$mill.)	\$17,848	\$14,644	\$20,824
Societal Benefits (\$mill.)	\$65,736	\$28,684	\$106,121
Net Benefits (\$mill.)	\$55,129	\$10,606	\$103,583
% Certainty Net Ben. > 0			

**FIGURE XII-14
Model Output Profile**

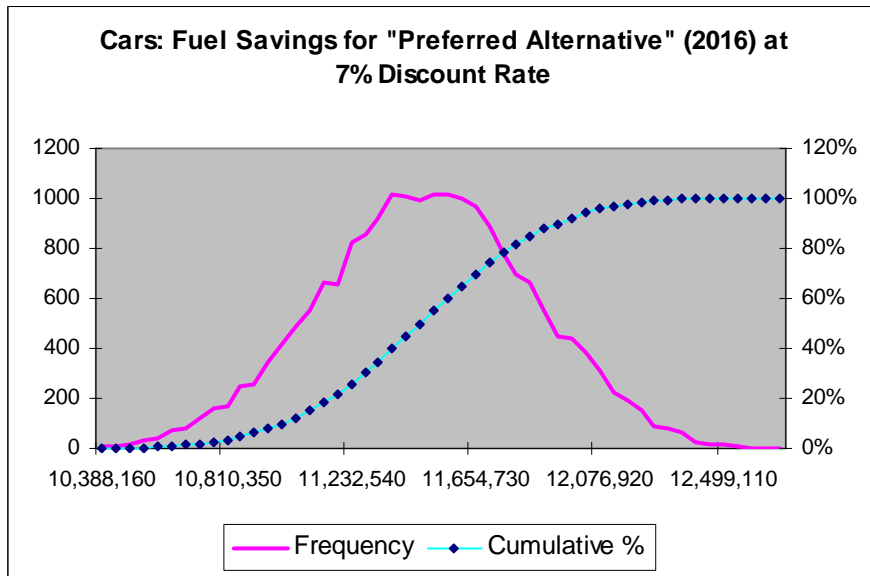

**FIGURE XII-15
Model Output Profile**

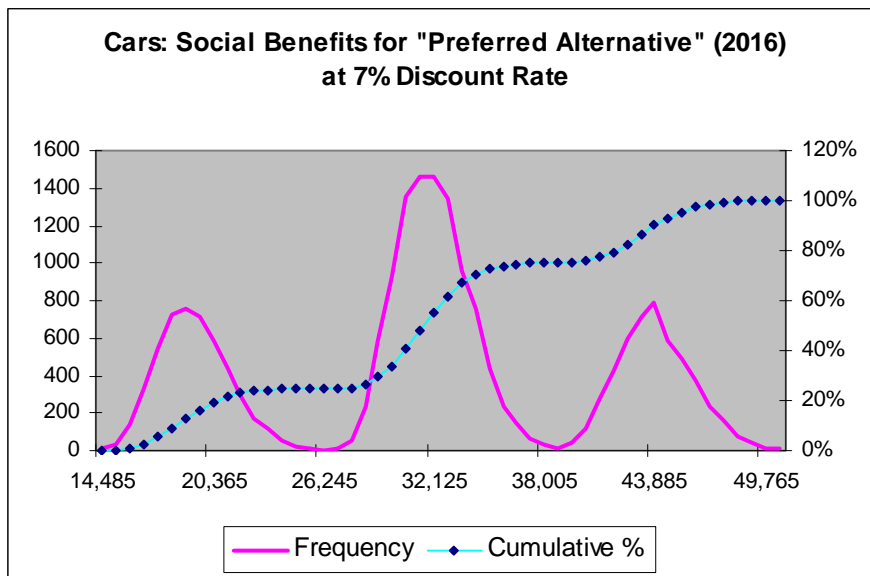

**FIGURE XII-16
Model Output Profile**

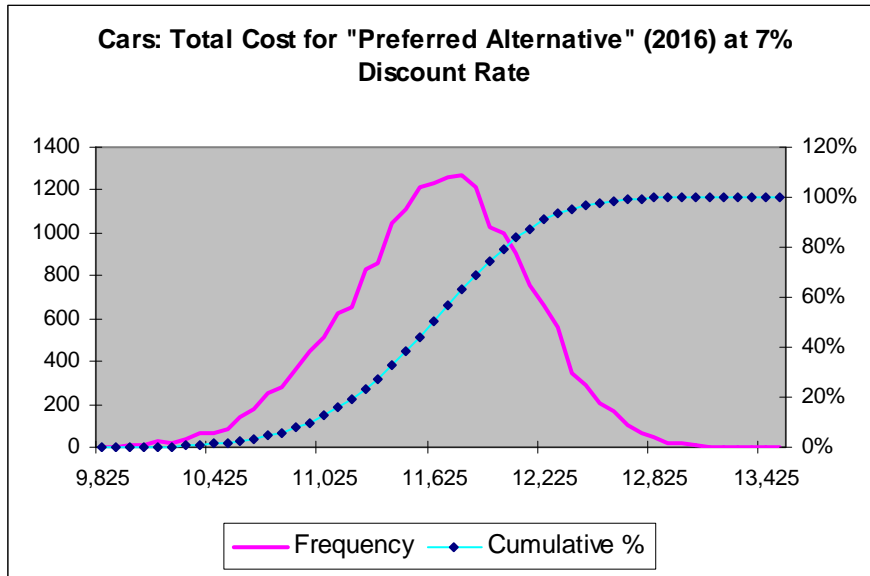

**FIGURE XII-17
Model Output Profile**

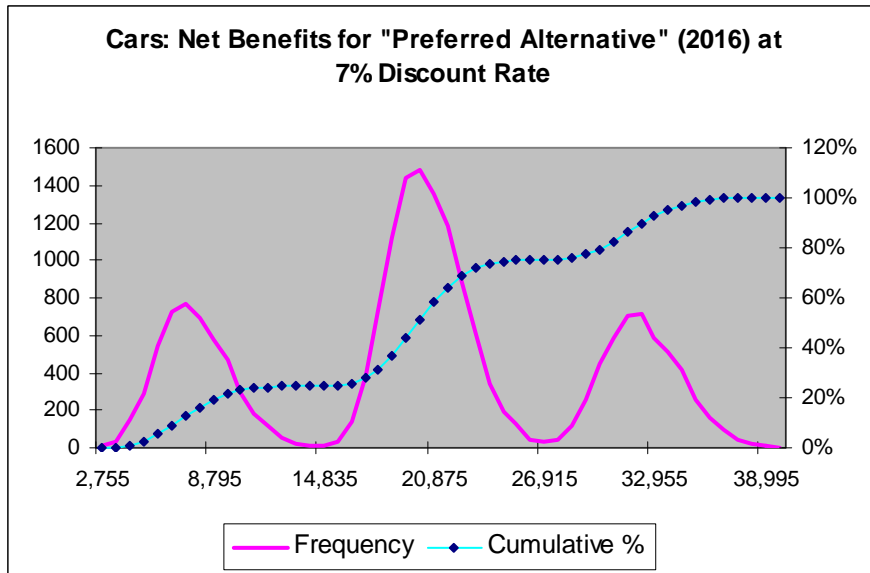

XIII. REGULATORY FLEXIBILITY ACT AND UNFUNDED MANDATES REFORM ACT ANALYSIS

Regulatory Flexibility Act

The Regulatory Flexibility Act of 1980 (5 U.S.C §601 *et seq.*) requires agencies to evaluate the potential effects of their proposed and final rules on small business, small organizations and small Government jurisdictions.

5 U.S.C §603 requires agencies to prepare and make available for public comments initial and final regulatory flexibility analysis (RFA) describing the impact of proposed and final rules on small entities. Section 603(b) of the Act specifies the content of a RFA. Each RFA must contain:

1. A description of the reasons why action by the agency is being considered;
2. A succinct statement of the objectives of, and legal basis for a final rule;
3. A description of and, where feasible, an estimate of the number of small entities to which the final rule will apply;
4. A description of the projected reporting, recording keeping and other compliance requirements of a final rule including an estimate of the classes of small entities which will be subject to the requirement and the type of professional skills necessary for preparation of the report or record;
5. An identification, to the extent practicable, of all relevant Federal rules which may duplicate, overlap or conflict with the final rule;
6. Each final regulatory flexibility analysis shall also contain a description of any significant alternatives to the final rule which accomplish the stated objectives of applicable statutes and which minimize any significant economic impact of the final rule on small entities.

1. Description of the reason why action by the agency is being considered
NHTSA is proposing this action to improve vehicle fuel economy.

2. Objectives of, and legal basis for, the final rule

The Energy Policy and Conservation Act requires the agency to set light truck fuel economy standards every year and allows the agency to update passenger car fuel economy standards. The Energy Independence and Security Act (EISA) mandates the setting of separate standards for passenger cars and for light trucks at levels sufficient to ensure that the average fuel economy of the combined fleet of all passenger cars and light trucks sold by all manufacturers in the U.S. in model year 2020 equals or exceeds 35 miles per gallon.

3. Description and estimate of the number of small entities to which the final rule will apply

The final rule will affect motor vehicle manufacturers. There are no light truck manufacturers that are small businesses. However, there are six domestically owned small passenger car manufacturers.

Business entities are defined as small business using the North American Industry Classification System (NAICS) code, for the purpose of receiving Small Business Administration assistance.

One of the criteria for determining size, as stated in 13 CFR 121.201, is the number of employees in the firm. For establishments primarily engaged in manufacturing or assembling automobiles, light and heavy duty trucks, buses, motor homes, or motor vehicle body manufacturing, the firm must have less than 1,000 employees to be classified as a small business.

We believe that the rulemaking would not have a significant economic impact on the small vehicle manufacturers because under Part 525, passenger car manufacturer making less than 10,000 vehicles per year can petition NHTSA to have alternative standards set for those manufacturers. Those manufacturers that currently don't meet the 27.5 mpg standard can petition the agency for relief. If the standard is raised, it has no meaningful impact on these manufacturers; they still must go through the same process and petition for relief. Other small manufacturers (Tesla and Fisker) make electric vehicles or hybrid vehicles that will pass the final rule.

Currently, there are six small passenger car motor vehicle manufacturers in the United States. Table XIII-1 provides information about the 6 small domestic manufacturers in MY 2007. All are small manufacturers, having much less than 1,000 employees.

Table XIII-1
Small Vehicle Manufacturers

Manufacturer	Employees	Estimated Sales	Sale Price Range	Est. Revenues*
Fisker Automotive**	N/A	15,000 projected	\$80,000	N/A
Mosler Automotive	25	20	\$189,000	\$2,000,000
Panoz Auto Development Company	50	150	\$90,000 to \$125,000	\$16,125,000
Saleen Inc.	170	1,000 [#]	\$39,000 to \$59,000	\$49,000,000
Saleen Inc.	170	16 ^{##}	\$585,000	\$9,000,000
Standard Taxi***	35	N/A	\$25,000	\$2,000,000
Tesla Motors, Inc.	250	2,000	\$65,000 to \$100,000	N/A

* Assuming an average sales price from the sales price range.

** Fisker Automotive is a joint venture of Quantum Fuel Systems Technologies Worldwide, Inc. and Fisker Coachbuild, LLC.

*** Standard Taxi is a subsidiary of the Vehicle Production Group LLC. 35 employees is the total for VPG LLC.

Ford Mustang Conversions

The agency has not analyzed the impact of the final rule on these small manufacturers individually. However, assuming those that do not meet the final rule would petition the agency, rather than meet the final rule, the cost is not expected to be substantial.

4. A description of the projected reporting, record keeping and other compliance requirements of a final rule including an estimate of the classes of small entities which will be subject to the requirement and the type of professional skills necessary for preparation of the report or record. This final rule includes no new requirements for reporting, record keeping of other compliance requirements.

5. An identification, to the extent practicable, of all relevant Federal rules which may duplicate, overlap, or conflict with the final rule

EPA and NHTSA are proposing joint rules which complement each other. We know of no other Federal rules which duplicate, overlap, or conflict with the final rule.

6. A description of any significant alternatives to the final rule which accomplish the stated objectives of applicable statutes and which minimize any significant economic impact of the final rule on small entities.

There are no other alternatives that can achieve the stated objectives without installing fuel economy technologies into the vehicle.

A. Unfunded Mandates Reform Act

The Unfunded Mandates Reform Act of 1995 (Public Law 104-4) requires agencies to prepare a written assessment of the costs, benefits, and other effects of proposed or final rules that include a Federal mandate likely to result in the expenditures by States, local or tribal governments, in the aggregate, or by the private sector, of more than \$100 million annually (adjusted annually for inflation with base year of 1995). Adjusting this amount by the implicit gross domestic product price deflator for the year 2008 results in \$133 million ($122.42 \div 92.106 = 1.33$). The assessment may be included in conjunction with other assessments, as it is here.
